



# COSMOS

---

Data sheet LINE 4800

Compression fittings with male nut

---

# Contents

DESCRIPTION	3
ADVANTAGES	3
FIELDS OF APPLICATION	4
SUITABLE PIPES	4
CLOSING COUPLES	4
COMPONENTS AND MATERIALS	5
REGULATIONS	6
CERTIFICATIONS	6
ASSEMBLY INSTRUCTIONS	7

LINE 4800

Compression fittings with male  
nut**COSMOS**



## DESCRIPTION

Compression fittings with male nut for Polyethylene pipe [LINE 4800] are suitable for supply of drinkable water, for irrigation installation (LDPE), for sanitary systems and for any kind of sanitary installation such as domestic, commercial, industry and farming and with any type of non-corrosive fluid.

## ADVANTAGES

- Complete range
- Suitable for drinking water
- Quick and easy installation
- Raw materials complying with UBA LIST

## FIELDS OF APPLICATION

APPLICATIONS		T. min.	T. max	T. of the system	Max. pressure
	drinking water	-20°C	+80°C	-20°C/+40°C	16 bar
	irrigation	-20°C	+80°C	-20°C/+40°C	16 bar

## SUITABLE PIPES





Polyethylene pipes.

## CLOSING COUPLES

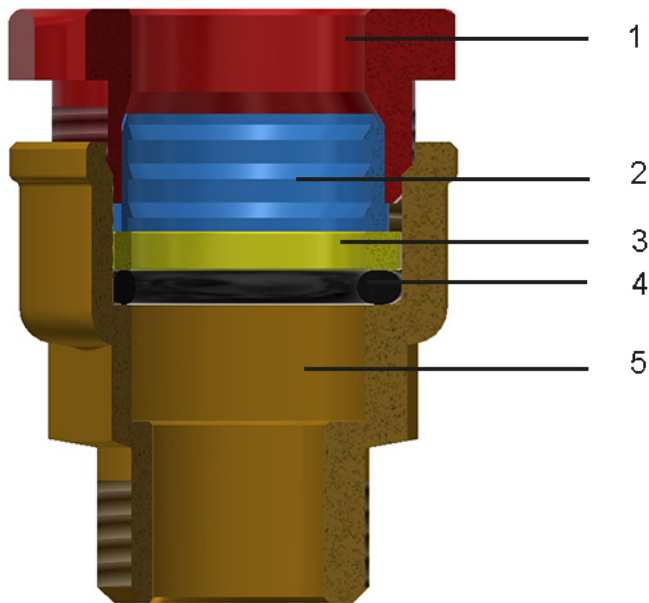
Ø	Torque (Nm)
Ø 20	23
Ø 25	32
Ø 32	38
Ø 40	43
Ø 50	60
Ø 63	130

## COMPONENTS AND MATERIALS



LEGEND		COMPONENTS	MATERIALS
	1	Closing ring	Brass CW617N - UNI EN 12165
	2	Cut olive	Brass CW617N - UNI EN 12164
	3	Flat ring	Brass CW617N - UNI EN 12164
	5	Body	Brass CW617N - UNI EN 12165
	4	O-Ring	Elastomer for drinking water (except for Germany)

## REGULATIONS

- UNI EN 1254-3

Fittings comply with UNI EN 1254-3 law: "Sanitary fittings for plastic pipes with compression ends".

- UNI EN ISO 228-1:2003

Threads complies with UNI EN ISO 228-1:2003 law: "Piping thread for coupling not with thightness on the thread".





















- D.M. 174 (06/04/2004)

Raw materials used are of high quality and comply with the Ministerial Decree N°174 dated 06/04/2004 concerning the materials and the items used in fixed installations for water collection, treatment and supply.

- Comply with 4MS, UBA List (BC group), DIN 50930/6 Dir. 2011/65/UE, 6C attachment III (RhOSII).

- Comply with DVGW DW335-B4 (P)

## CERTIFICATIONS

COUNTRY	CERTIFICATION	COUNTRY	CERTIFICATION	COUNTRY	CERTIFICATION
					
					
					
					

## ASSEMBLY INSTRUCTIONS

Mark and cut the pipe perpendicularly to its axis using an appropriate pipe-cutting tool [code TT50.00] or a saw with fine springs. The pipe has to be marked in order to let it sort out at the end of its seat once inserted in the fitting and before screwing the nut. The pipe has to be fettled to avoid O-Ring damages. Remove possible residual burr.

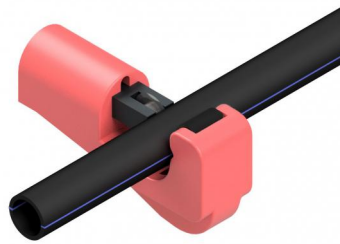

Insert the components on the pipe according to sequence that follows: nut, cut olive (external surface marks have to be directed forward the nut and not forward the fitting), compression ring and gasket (and at the end the sleeve, where expected).



Place the pipe and the components in the fitting, blocking manually the system with the nut screwing. Close the nut using a fixed spanner or a suitable tool giving a screwing coupling as shown in the table [previous page]

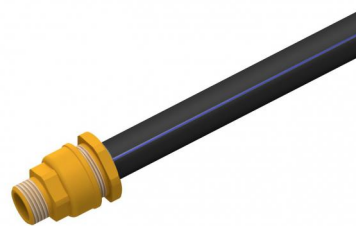

It's suggested to check the nut closing after a seal and pipe adjustment period [24h].

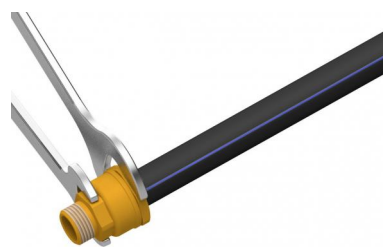





GENERAL FITTINGS SPA

Via Golgi 73/75, 25064 Gussago (BS) - ITALY

te. +39 030 3739017

[www.generalfittings.it](http://www.generalfittings.it)