

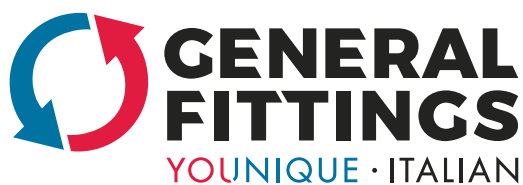

















CATALOGO CATALOG 2024/2025













Componenti
idrotermosanitari
Plumbing & heating
components



ICONE ICONS

	MISURA SIZE		SPESSORE THICKNESS		VIE WAYS
	CONNESSIONI CONNECTIONS		USCITE OUTLETS		MANDATA DELIVERY
	INTERASSE INTERAXIS		MISURA INTERNA INTERNAL SIZE		MISURA ESTERNA EXTERNAL SIZE
	ALLUMINIO ALUMINIUM		ROTOLO COIL		BARRA BAR
	PALLET PALLET		SACCHETTO BAG		SCATOLA BOX
	NOTE NOTE		PREZZO PRICE		SENSO LETTURA RACCORDO A T TEE READING DIRECTION

APPLICAZIONI APPLICATIONS

	acqua calda sanitaria hot sanitary water		acqua potabile drinking water		aria compressa compressed air
	condizionamento conditioning		gas gas		irrigazione irrigation
	radiatori radiators		raffrescamento cooling		riscaldamento a parete low temp. heating (wall)
	riscaldamento a pavimento floor heating		riscaldamento a soffitto low temp. heating (ceiling)		solare solar

WEBSITE

Tante novità da scoprire.

Uno spazio per conoscerci meglio, scoprire chi siamo e quali sono i nostri valori. È la porta d'entrata più comoda ed immediata per vedere i nostri prodotti con i dati aggiornati e scaricare tutta la documentazione.

WWW.GENERALFITTINGS.IT

GENERAL FITTINGS È SOCIAL!

Ogni settimana sui nostri canali social puoi trovare contenuti riguardanti l'azienda, i prodotti, le novità, approfondimenti. Un modo per far parte della nostra community e rimanere aggiornato. Se ancora non ci segui non perdere tempo.

Scannerizza e seguici!

WEBSITE

Plenty of news to discover. A space to find out who we are and our values. It is the most convenient and immediate gateway to discover our products and updates and download all related documents.

WWW.GENERALFITTINGS.IT

GENERAL FITTINGS GOES SOCIAL!

Every week, on our social media channels you can find news, updates and insights about our company and our products. It is a quick and easy way to join our community. Come and follow us.

SCAN THE QR CODES AND FOLLOW US!



WEBSITE



YOUTUBE



FACEBOOK



INSTAGRAM



LINKEDIN

YOUNIQUE · ITALIAN



IL FUTURO PARTE DA NOI THE FUTURE STARTS WITH US

Progettiamo e produciamo soluzioni efficienti per il mercato idrotermosanitario dal 1981. Siamo il partner ideale per la fornitura di sistemi (raccordi, collettori, valvole, unità di miscelazione, pannelli radianti) per tubi multistrato, PE-X, rame, PE, acciaio e ferro. Grazie ad un team coeso, affrontiamo le sfide del mercato mettendo al primo posto la qualità di prodotti 100% Made in Italy e le esigenze dei nostri partners. Una filosofia basata sul controllo dell'intera filiera produttiva e sull'evoluzione costante delle nostre proposte. Il motore del nostro lavoro è la passione che ci spinge innanzitutto a fare scelte che privilegiano le persone, poiché le risorse umane sono il nostro capitale più importante. Sono loro che fanno la differenza e costruiscono valore.

INVESTIAMO IN TECNOLOGIA E PROCESSI PRODUTTIVI PER CREARE BENESSERE PER LE PERSONE



We have been designing and manufacturing efficient solutions for the plumbing and heating market since 1981. We are the perfect partner to supply systems (fittings, manifolds, mixing units, radiant panels) for multilayer, PE-X, copper, PE, stainless steel and iron pipes. Thanks to a highly professional and cohesive team, we face the challenges of the market by putting quality and our partners' needs first. Our products are 100% made in Italy and our philosophy is based on the full control of the entire production chain, as well as the constant evolution of our proposals. Our driving force is passion, encouraging us first and foremost to focus on the value of people, as human resources are our most important capital.

WE INVEST IN TECHNOLOGY AND PRODUCTION PROCESSES TO CREATE WELL-BEING FOR PEOPLE



CRESCERE, EVOLVERSI E PUNTARE AL FUTURO GROW, EVOLVE AND CULTIVATE THE FUTURE

In collaborazione con l'artista veneziano PEETA General Fittings, che da 40 anni produce raccordi, valvole e collettori per impianti idrotermosanitari, punta all'arte come forma di comunicazione e rappresentazione della propria dinamicità e italianità.

"Per noi questa diventa anche un'occasione di incontro tra arte ed impresa: un dialogo per contribuire a diffondere cultura, per sviluppare relazioni inedite, imparare a pensare fuori dagli schemi e guardare alle cose con occhi diversi"

Cit. Luca Gambari, CEO di General Fittings.

General Fittings has been manufacturing fittings, valves and manifolds for plumbing and heating systems since 1981. We cultivate art as a form of communication to represent our dynamism and our Italian character. A collaboration project was therefore launched with the Venetian artist PEETA, aimed at enhancing our company's values.

"This is for us an opportunity to combine art and business in a dialogue aimed to spread culture and develop new relationships, make us learn to think out of the box and look at things through different eyes".

Luca Gambari, CEO of General Fittings

PRESENZA IN OLTRE 80 PAESI NEL MONDO PRESENT IN OVER 80 COUNTRIES

+15.000 TON. DI OTTONE TRASFORMATO
+15.000 TONS OF BRASS TRANSFORMED

+200MLN DI PEZZI LAVORATI ANNUALMENTE
+200MLN COMPONENTS MACHINED EACH YEAR



 **GENERAL
FITTINGS**

 **GENERAL
FITTINGS**



QUALITÀ: PASSIONE E ORGOGLIO

QUALITY: OUR PASSION AND PRIDE

Nel corso di 40 anni di attività General Fittings ha sviluppato un processo produttivo all'avanguardia, controllando tutte le fasi in modo preciso e attento.

In these 40 years, General Fittings has developed advanced manufacturing processes, all stages of which are controlled in a very careful and accurate way.

100% MADE IN ITALY

Il nostro prodotto è totalmente italiano. Le materie prime, di origine certificata, sono lavorate esclusivamente all'interno del nostro stabilimento di Gussago (BS): ciò è fondamentale per garantire al cliente un prodotto di ottima qualità. Il nostro sistema di qualità è certificato ISO 9001. Grazie al nostro impegno abbiamo ottenuto e rinnovato negli anni l'esclusiva certificazione "Made in Italy" rilasciata dal Kiwa, ente tra i leader globali nel settore delle certificazioni.

Our products are entirely Made in Italy. All raw materials are of certified origin and exclusively processed at our production facility in Gussago (Brescia), as this is essential for ensuring our partners top quality. Our quality system is certified ISO 9001. Our strong commitment has allowed us to achieve the exclusive "Made in Italy" certificate issued by Kiwa, a leading certification body at the global level, and to have it renewed over the years.

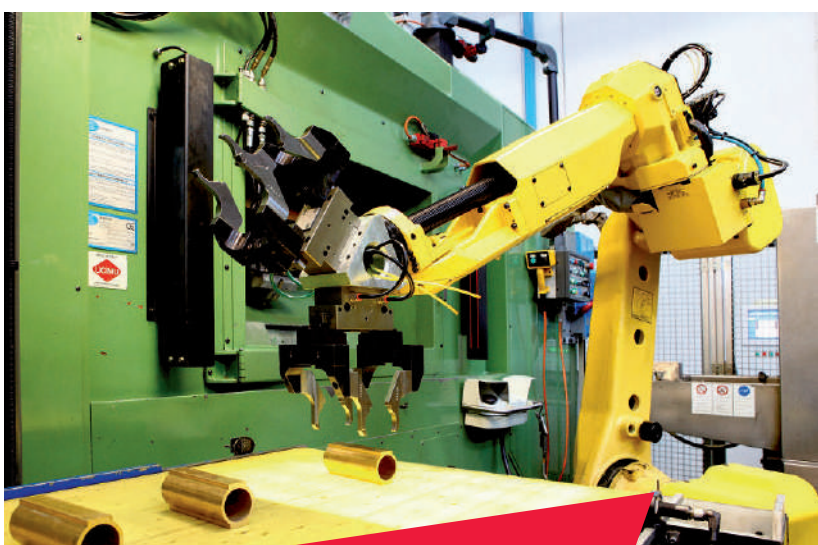

CERTIFICAZIONI

CERTIFICATES

I nostri prodotti sono inoltre riconosciuti da numerosi e importanti enti di certificazione nazionali ed internazionali, permettendone l'esportazione in tutto il mondo.

Our products are acknowledged and certified by numerous certification bodies, both national and international, and are suitable for export all over the world.





VARMO

VARMO è la linea di riscaldamento a pavimento di General Fittings ideale sia per le nuove costruzioni che per le ristrutturazioni. Il sistema radiante VARMO offre molteplici soluzioni tra cui scegliere in base alle proprie esigenze: pannelli per applicazioni tradizionali (con massetto) e sistemi a secco e bassa inerzia (senza massetto). General Fittings si propone così come un unico interlocutore per pannelli, tubi, collettori, centraline di distribuzione e tutti gli strumenti e accessori complementari. La versatilità della nostra offerta è accompagnata da un SERVIZIO dedicato: varmo@generalfittings.it.

VARMO is the underfloor heating line from General Fittings ideal for both new buildings and for renovations. VARMO radiant system offers multiple solutions from which to choose according to one's needs: panels for traditional applications (with screed) and dry and low inertia systems (without screed). General Fittings thus proposes itself as a single point of contact for panels, pipes, manifolds, distribution units and all the complementary tools and accessories. The versatility of our offer is accompanied by a dedicated SERVICE: varmo@generalfittings.it.

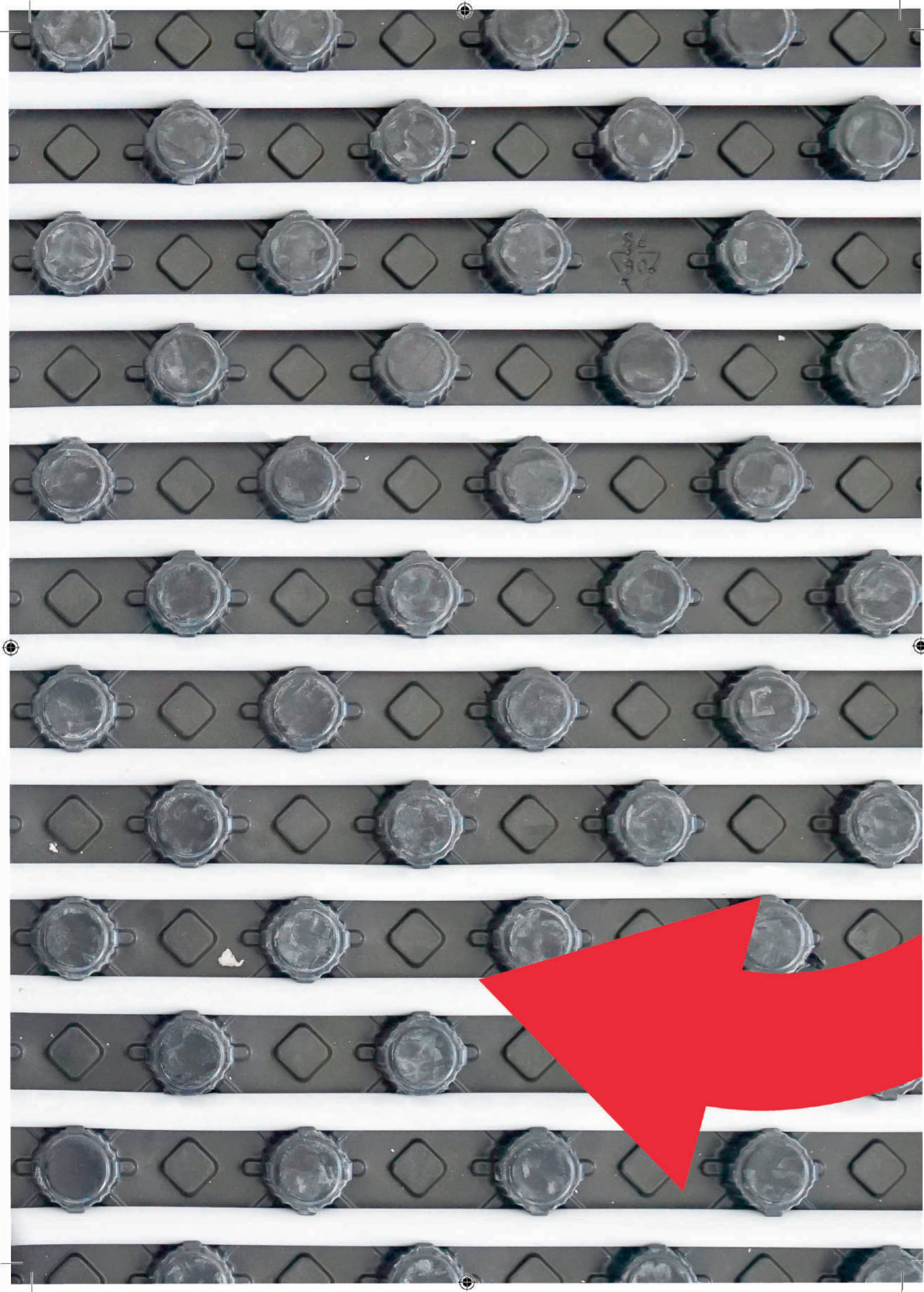

INDICE

RACCORDI PER TUBO RAME

AMON 1N00 Raccordi a compressione con ogiva in ottone	18
AMON 1N00 STAGNATA Raccordi a compressione con ogiva in ottone	32
AMON 1N00 DZR Raccordi a compressione con ogiva in ottone	42
HORUS 1200 Raccordi a compressione con tenuta O-Ring	58
SOBEK 1400 Raccordi cromati per idrosanitaria	68

RACCORDI PER TUBO FERRO

CLIO 2600-2700 Raccordi filettati in ottone	78
CLIO 2600-2700 DZR Raccordi filettati in ottone	134
CLIO 2100 Raccordi di riparazione	140

SISTEMI PER TUBO PE-X

COMP_FIX 3300 Raccordi a compressione con dado ed ogiva tagliata	146
Gold-Fix 3400 Raccordi a pressatura assiale per tubo Pe-X e multistrato	160
Gold-Therm 3400 Raccordi nichelati a pressatura assiale per tubo Pe-X	180
Tubi Pe-X	190
Tubi multistrato pressatura assiale	196

RACCORDI PER TUBO POLIETILENE

KRATOS 4500 Raccordi a compressione con ghiera femmina	204
COSMOS 4800 Raccordi a compressione con ghiera maschio	214

SISTEMI PER TUBO MULTISTRATO

SAFE_PRESS 5T00 Raccordi a pressare multiprofilo e sistema LBP	228
URANO 5S00 Raccordi a pressare multiprofilo	248
EWOPREX Raccordi a pressare multiprofilo con trattamento galvanico e sistema LBP	266
TRIDENT 5G00 Raccordi a pressare multiprofilo per acqua, gas e riscaldamento	282
COMPRESX 5300 Raccordi a compressione con ogiva tagliata	294
COMPRESX 5E00 Raccordi a compressione con inserto e ogiva tagliata	306
WOFLEX Raccordi a compressione con inserto e ogiva tagliata	314
Raccordi eurocono	322
Tubi multistrato per acqua	324
Tubi multistrato per gas	334
Tubi Welcoflex	338
Accessori per sistemi tubo multistrato	346

COLLETTORI DI DISTRIBUZIONE

FLEXUS Collettori sanitari fasati	354
FLEXUS 90° Collettori sanitari fasati	374
Collettori sanitari	392
Collettori da barra	404
WELCODUAL Collettori complanari	412
Collettori per contatore	430

INDICE

Inseri e adattatori	434
Adattatori sede piana	440
Accessori collettori di distribuzione	442

COLLETTORI IMPIANTI RADIANTI

TRITONE Centralina di miscelazione	448
HOLLER Gruppi di miscelazione con regolazione a punto fisso	468
THOR Collettori in acciaio inox	482
ODINO Collettori in ottone	508
LOKI Collettori modulari in ottone	536
Accessori collettori per riscaldamento	552

VALVOLE E RUBINETTI

ZEFIRO 7S00 Valvole a sfera passaggio standard- ISO 228/1	562
NOTO 7100 Valvole a sfera passaggio totale - ISO 228/1	568
Altre valvole e filtri	578
IDROS Rubinetti sottolavabo	582
IDROS Rubinetti lavatrice	586

VALVOLE PER RADIATORE

FEBO 7E00 Valvole e detentori per radiatore HYPERION	592
7500 Valvole e detentori per radiatore	600
Comandi termostatici	612
Adattatori ed inserti per valvole radiatore	620

NOVITA' MERCATO ITALIA
ITALIAN MARKET
NEW PRODUCTS

p.32



TN00 STAGNATA/TIN PLATED

Raccordi a compressione
con ogiva in ottone
Compression fittings with
brass olive

p.160



Gold-Fix

Raccordi a pressatura assiale
per tubo Pe-X e multistrato
Axial press fittings for Pe-X
and multilayer pipes

p.180



Gold-Therm

Raccordi a pressatura assiale
per tubo Pe-X
Axial press fittings for Pe-X pipes

p.228



SAFE_PRESS

Raccordi a pressare multiprofilo
con sistema Leak Before Press
Multilayer press fittings with
Leak Before Press system

p.324



Tubi multistrato per acqua
Pe-Xc/Al/Pe-Xc
Pe-Xc/Al/Pe-Xc multilayer
pipes for water

p.374



FLEXUS90°

Collettori fasati allineati
Self-aligned manifolds

p.482



THOR

Collettori in acciaio inox
per sistemi di riscaldamento
Stainless steel manifolds

p.536



LOKI

Collettori modulari
per sistemi di riscaldamento
Modular manifolds for heating systems

p.555



Valvole a sfera compatte per collettori
per impianti di riscaldamento e
raffrescamento
Compact ball valves for manifolds for
heating and cooling systems

INDEX

FITTINGS FOR COPPER PIPE

AMON 1N00 Compression fittings with brass olive	18
AMON 1N00 TIN PLATED Compression fittings with brass olive	32
AMON 1N00 DZR Compression fittings with brass olive	42
HORUS 1200 Compression fittings with O-Ring	58
SOBEK 1400 Sanitary chrome plated fittings	68

FITTINGS FOR IRON PIPE

CLIO 2600-2700 Brass threaded fittings	78
CLIO 2600-2700 DZR Brass threaded fittings	134
CLIO 2100 Repairing fittings	140

PE-X PIPE SYSTEMS

COMP_FIX 3300 Compression fittings with cut brass olive	146
Gold-Fix 3400 Axial press fittings for Pe-X and Pe-X/Al/Pe-X pipes	160
Gold-Therm 3400 Axial press nickel-plated fittings for Pe-X pipes	180
Pe-X pipes	190
Axial pressing multilayer pipes	196

FITTINGS FOR POLYETHYLENE PIPE

KRATOS 4500 Compression fittings with female nut	204
COSMOS 4800 Compression fittings with male nut	214

MULTILAYER PIPE SYSTEMS

SAFE_PRESS 5T00 Multijaws press fittings with LBP system	228
URANO 5S00 Multijaws press fittings	248
EWOPREX Multijaws press fittings with galvanic treatment and LBP system	266
TRIDENT 5G00 Press fittings for gas, heating and water	282
COMPRESX 5300 Compression fittings with cut brass olive	294
COMPRESX 5E00 Compression fittings with removable pipe holder and cut olive	306
WOFLEX Compression fittings with removable pipe holder and cut olive	314
Eurocone fittings	322
Multilayer pipes for water	324
Multilayer pipes for gas installations	334
Welcoflex pipes	338
Multilayer pipe systems accessories	346

DISTRIBUTION MANIFOLDS

FLEXUS Self-aligned manifolds	354
FLEXUS 90° Self-aligned manifolds	374
Sanitary manifolds	392
Bar manifolds	404
WELCODUAL Coplanar manifolds	412
Water meter manifolds	430

INDEX

Inserts and adapters	434
Flat seal adapters	440
Distribution manifold accessories	442

MANIFOLDS FOR RADIANT SYSTEMS

TRITONE Mixing unit	448
HOLLER Fixed point mixing station	468
THOR Stainless steel manifolds for radiant systems	482
ODINO Brass manifolds	508
LOKI Modular brass manifolds	536
Heating manifold accessories	552

VALVES AND TAPS

ZEFIRO 7S00 Standard bore ball valves - ISO 228/1	562
NOTO 7100 Full bore ball valves - ISO 228/1	568
Other valves and filters	578
IDROS Angle valves	582
IDROS Washing machine taps	586

RADIATOR VALVES

FEBO 7E00 Valves and lockshields for radiator	592
HYPERION 7500 Valves and lockshields for radiator	600
Thermostatic controls	612
Adapters and inserts for radiator valves	620

NOVITA' MERCATO ESTERO
FOREIGN MARKETS
NEW PRODUCTS

p.174



Gold-Fix

3400.82.P
Bussola in plastica
Plastic sleeve

p.180



Gold-Therm

Raccordi a pressatura assiale
per tubo Pe-X
Axial press fittings for Pe-X pipes

p.228



SAFE_PRESS

Disponibili nuove misure 25x2.5
New 25x2.5 sizes available
5T00.00;5T00.01; 5T00.02; 5T00.03; 5T00.07; 5T00.10;
5T00.11; 5T00.12;5T00.13;5T00.20; 5T00.21; 5T00.22;
5T00.23;5T00.C1

p.245



SAFE_PRESS

5T00.E5-AC00.70
Raccordo a T By-pass e guscio isolante
Tee By-Pass and insulating box

p.266



EWO PREX

Raccordi a pressione multiprofilo con trattamento galvanico e sistema LBP
Multijaws press fittings for multilayer pipe with galvanic treatment and LBP system

p.374



FLEXUS 90°

Collettori fasati allineati
Self-aligned manifolds

p.482



THOR

Collettori in acciaio inox per sistemi di riscaldamento
Stainless steel manifolds

p.536



LOKI

Collettori modulari per sistemi di riscaldamento
Modular manifolds for heating systems

p.555



Valvole a sfera compatte per collettori per impianti di riscaldamento e raffreddamento
Compact ball valves for manifolds for heating and cooling systems

RACCORDI PER
TUBO RAME
*FITTINGS FOR
COPPER PIPE*

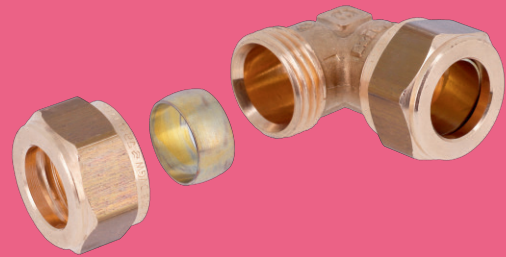



AMON

SERIE 1N00 LINE 1N00



Raccordi a compressione con ogiva in ottone Compression fittings with brass olive

I raccordi della SERIE 1N00 sono raccordi a compressione a tenuta completamente metallica conformi ai requisiti della norma EN1254-2.

Tutte le filettature sono conformi alla norma UNI EN 10226-1: "Filettatura di tubazioni per accoppiamento a tenuta sul filetto".

La raccorderia della Serie 1N00 è utilizzabile in un'ampia gamma di applicazioni per la distribuzione di acqua e di gas, sia nell'impiantistica civile che industriale.

Brass fittings belonging to LINE 1N00 series feature a fully metallic body and are designed according to EN 1254-2 standard.

Threads comply with UNI EN 10226-1 law: "Piping thread for coupling on the thread".

Line 1N00 fittings can be used for the supply and distribution of sanitary hot and cold water and heating and for the distribution of natural gas, both in civil and industrial installations.









VANTAGGI

- Utilizzabile per acqua sanitaria, riscaldamento, gas, solare, aria compressa
- Ampiezza gamma
- Tenuta metallica
- Estrema semplicità di montaggio
- Materie prime impiegate di alta qualità [UBA LIST]
- Idoneità al contatto con acqua potabile
- Grande robustezza
- Sicurezza garantita con omologazioni DVGW, KIWA, WRAS
- Dado di qualità SUPERIORE ricavato direttamente da barra
- Utilizzabile per tubo in rame e acciaio
- Disponibile in versione stagnata

ADVANTAGES



- Suitable for sanitary water, heating, gas, compressed air, solar installations
- Wide range
- Metallic sealing
- Easy to assemble
- Raw materials complying with UBA LIST
- Suitable for drinking water
- Durability
- Guaranteed safety (DVGW, KIWA, WRAS certifications)
- Superior quality nut obtained directly from bar
- Suitable both for copper and inox pipe
- Tin plated version available

CAMPI DI APPLICAZIONI E PRESTAZIONI FIELDS OF APPLICATION

APPLICAZIONI APPLICATIONS		T. min.	T. max	Press.max Max. pressure
	acqua potabile drinking water	-20°C	+120°C	16 bar
	acqua calda sanitaria sanitary hot water	-20°C	+120°C	16 bar
	condizionamento conditioning	-20°C	+120°C	16 bar
	radiatori radiators	-20°C	+120°C	16 bar
	irrigazione irrigation	-20°C	+120°C	16 bar
	gas gas	-20°C	+70°C	1 bar
	aria compressa compressed air	-20°C	+30°C	10 bar
	solare solar	-20°C	+200°C	9 bar
	-20°C: solo con liquido antigelo glicole in % max del 50% -20°C: with the use of glycol in a maximum percentage of 50%			

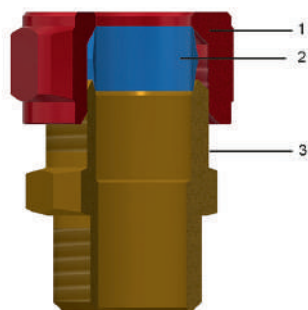
COMPONENTI E MATERIALI COMPONENTS AND MATERIALS



LEGENDA LEGEND	COMPONENTI COMPONENTS	MATERIALI MATERIALS
	1 Dado Nut	Ottone CW614N - UNI EN 12164 Brass CW614N - UNI EN 12164
	2 Ogiva Olive	Ottone CW603N - UNI EN 12164 Brass CW603N - UNI EN 12164
	3 Corpo Body	Ottone CW617N/CW612N - UNI EN 12165 Brass CW617N/CW612N - UNI EN 12165

NORMATIVE

- UNI EN 1254-2
I raccordi sono conformi alla norma UNI EN 1254-2:
"Raccorderia idraulica per tubazioni rame con terminali a compressione."
- UNI EN 10226-1
Tutte le filettature sono conformi alla norma UNI EN 10226-1: "Filettatura di tubazioni per accoppiamento a tenuta sul filetto".
- D.M. 174 (06/04/2004)

REGULATIONS

- UNI EN 1254-2
Fittings comply with UNI EN 1254-2 law: "Plumbing fittings - Fittings with compression ends for use with copper tubes."
- UNI EN 10226-1
Threads comply with UNI EN 10226-1 law: "Piping thread for coupling on the thread".
- D.M. 174 (06/04/2004)
Raw materials used are of high quality and comply with the

I materiali utilizzati sono conformi al Decreto Ministeriale n° 174 del 06/04/2004 [Regolamento concernente i materiali e gli oggetti che possono essere utilizzati negli impianti fissi di captazione, trattamento, adduzione e distribuzione delle acque destinate al consumo umano].

- I raccordi vengono utilizzati con modalità e prescrizioni previste dalle vigenti normative in materia di impianti di distribuzione del gas: UNI-CIG 7129 per gas metano, UNI-CIG 7131 per gas G.P.L. e UNI-CIG 9860 criteri per la progettazione, la costruzione, il collaudo. L'impiego di raccordi a compressione con ogiva metallica per tubi di rame, è prescritto dal D.M. 12 Aprile 1996 - pubblicato sulla G.U. n° 103 del 4 Maggio 1996 - Art. 5.3.2 - comma b.
- Conforme a 4MS, UBA List (gruppo BC), DIN 50930/6 Dir. 2011/65/UE, 6C allegato III (RhOSII)
- Certificati secondo standard olandese per applicazioni gas MOP 1 bar e standard tedesco GW392 - DIN3387.

Ministerial Decree N°174 dated 06/04/2004 concerning the materials and the items used in fixed installations for water collection, treatment and supply.

• UNI-CIG 7129, UNI-CIG 7131, UNI-CIG9860

Fittings are used with methods and prescriptions provided for by the current regulations for gas distribution systems: UNI-CIG 7129 for natural gas, UNI-CIG 7131 for G.P.L. and UNI-CIG 9860 criteria for design, construction, testing. The use of compression fittings with metal ferrule for copper pipes is prescribed by Ministerial Decree April 12, 1996 - published in the G.U. No. 103 of 4 May 1996 - Art. 5.3.2 - paragraph b.

• Comply with 4MS, UBA List (BC group), DIN 50930/6 Dir. 2011/65/UE, 6C attachment III (RhOSII).

• Certified according to the Dutch Standard for gas applications MOP 1 bar and the German standard GW392 - DIN3387.

CERTIFICAZIONI CERTIFICATIONS

STATO COUNTRY	CERTIFICAZIONE CERTIFICATION	STATO COUNTRY	CERTIFICAZIONE CERTIFICATION	STATO COUNTRY	CERTIFICAZIONE CERTIFICATION
					
					
					
					

TUBI COMPATIBILI

Tubi in rame per applicazioni sanitarie secondo la norma EN 1057.

Tubi in acciaio galvanizzato secondo la norma EN 10305-2 o in acciaio inossidabile conforme alla norma EN 10312.

SUITABLE PIPES

Copper pipes for sanitary installations complying with EN 1057 standard.

Galvanised steel precision tube in accordance with EN 10305-2 or stainless steel tube conforming to EN 10312.

N° GIRI DI SERRAGGIO RACCORDI PRESCRIBED NUMBER OF TIGHTENING TURNS

Diametro Diam.	Tubo Pipe	N° di giri N° turns	Tolleranza Tolerance	Coppia di chiusura Tightening
8	Cu R220	1+3/4 giro-turn	+1/4 giro-turn	20 N*m
10	Cu R220	1/2 giro-turn	+1/4 giro-turn	< 20 N*m
10	Cu R250	3/4 giro-turn	+1/4 giro-turn	20 N*m
10	Cu R290	3/4 giro-turn	+1/4 giro-turn	30 N*m
12	Cu R220	3/4 giro-turn	+1/4 giro-turn	25 N*m
12	Cu R250	3/4 giro-turn	+1/4 giro-turn	40 N*m
12	Cu R290	3/4 giro-turn	+1/4 giro-turn	40 N*m
12	Acciaio al carbonio Carbon steel	1/2 giro-turn	+1/4 giro-turn	50 N*m
15	Cu R220	3/4 giro-turn	+1/4 giro-turn	28 N*m
15	Cu R250	3/4 giro-turn	+1/4 giro-turn	40 N*m
15	Cu R290	3/4 giro-turn	+1/4 giro-turn	40 N*m
15	Acciaio al carbonio Carbon steel	1 giro-turn	+1/4 giro-turn	45 N*m
15	Acciaio INOX Stainless steel	3/4 giro-turn	+1/4 giro-turn	50 N*m
18	Cu R220	3/4 giro-turn	+1/4 giro-turn	30 N*m
18	Cu R250	3/4 giro-turn	+1/4 giro-turn	45 N*m
18	Cu R290	3/4 giro-turn	+1/4 giro-turn	45 N*m
18	Acciaio al carbonio Carbon steel	1+1/4 giro-turn	+1/4 giro-turn	140 N*m
18	Acciaio INOX Stainless steel	1+1/4 giro-turn	+1/4 giro-turn	140 N*m
22	Cu R220	3/4 giro-turn	+1/4 giro-turn	30 N*m
22	Cu R250	1/2 giro-turn	+1/4 giro-turn	45 N*m
22	Cu R290	1/2 giro-turn	+1/4 giro-turn	60 N*m
22	Acciaio al carbonio Carbon steel	1+1/4 giro-turn	+1/4 giro-turn	180 N*m
22	Acciaio INOX Stainless steel	1+1/4 giro-turn	+1/4 giro-turn	180 N*m
28	Cu R220	1/2 giro-turn	+1/4 giro-turn	40 N*m
28	Cu R290	1/2 giro-turn	+1/4 giro-turn	80 N*m
28	Acciaio al carbonio Carbon steel	1+1/4 giro-turn	+1/4 giro-turn	
28	Acciaio INOX Stainless steel	1+1/4 giro-turn	+1/4 giro-turn	
35	Cu R290	1/2 giro-turn	+1/4 giro-turn	110 N*m
35	Acciaio al carbonio Carbon steel	1 giro-turn	/	
35	Acciaio INOX Stainless steel	1 giro-turn	/	
42	Cu R290	1/2 giro-turn	+1/4 giro-turn	150 N*m
42	Acciaio al carbonio Carbon steel	1 giro-turn	/	
42	Acciaio INOX Stainless steel	1 giro-turn	/	
54	Cu R290	1/2 giro-turn	+1/4 giro-turn	190 N*m
54	Acciaio al carbonio Carbon steel	1 giro-turn	/	
54	Acciaio INOX Stainless steel	1 giro-turn	/	

ISTRUZIONI DI MONTAGGIO
ASSEMBLY INSTRUCTIONS

Utilizzando un apposito utensile taglia tubi [codice TT50.00] eseguire un taglio perpendicolare all'asse del tubo. Eliminare l'eventuale bava residua.

*Cut the pipe perpendicularly to its axis using an appropriate pipe-cutting tool [code TT500.00].
Remove possible residual burr.*

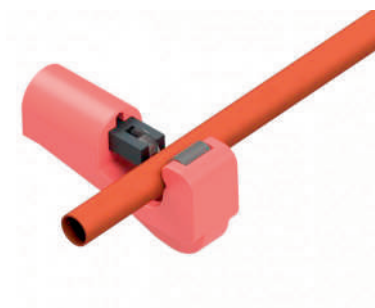

Inserire dado e ogiva sul tubo.

Insert nut and olive on the pipe.

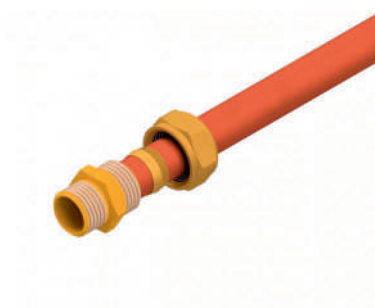

Inserire il tubo nel corpo fino a battuta e avvitare il dado a mano, per quanto consentito.

Insert the pipe in the body until it stops and tighten the nut by hand until allowed.

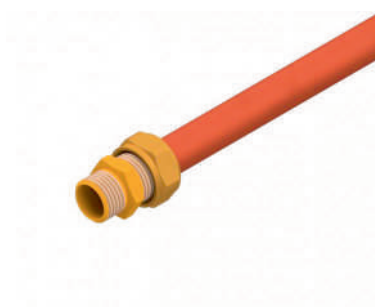

Con chiave esagonale avvitare il dado fino a raggiungere il numero massimo di giri (come indicato nella precedente tabella).

With an hexagonal wrench, tighten the nut until reaching the number of threads shown in the table (previous page)



1N00.00RACCORDO DIRITTO DOPPIO
DOUBLE STRAIGHT FITTING

CODICE	i	Ø	◇	☐
1N0000H060600A		6x6	10	300
1N0000H080800A		8x8	10	250
1N0000H101000A		10x10	10	200
1N0000H121200A		12x12	10	150
1N0000H141400A	a richiesta	14x14	10	100
1N0000H151500A	a richiesta	15x15	10	100
1N0000H161600A		16x16	10	100
1N0000H181800A		18x18	10	100
1N0000H222200A		22x22	10	50
1N0000H282800A		28x28	5	30
1N0000H353500A		35x35	-	20
1N0000H424200A		42x42	-	10
1N0000H545400A		54x54	-	5

1N00.01RACCORDO DIRITTO MASCHIO
MALE STRAIGHT FITTING

CODICE	i	Ø	◇	☐
1N0001H020600A		1/4"x6	10	300
1N0001H020800A		1/4"x8	10	300
1N0001H021200A		1/4"x12	10	200
1N0001H021500A		1/4"x15	10	180
1N0001H030800A		3/8"x8	10	300
1N0001H031000A		3/8"x10	10	200
1N0001H031200A		3/8"x12	10	200
1N0001H031500A		3/8"x15	10	180
1N0001H040800A		1/2"x8	10	150
1N0001H041000A		1/2"x10	10	150
1N0001H041200A		1/2"x12	10	150
1N0001H041400A		1/2"x14	10	100
1N0001H041500A		1/2"x15	10	100
1N0001H041600A		1/2"x16	10	100
1N0001H041800A		1/2"x18	10	100
1N0001H042200A		1/2"x22	10	70
1N0001H051400A		3/4"x14	10	80
1N0001H051500A		3/4"x15	10	80
1N0001H051600A		3/4"x16	10	80
1N0001H051800A		3/4"x18	10	70
1N0001H052200A		3/4"x22	10	50
1N0001H052800A		3/4"x28	5	50
1N0001H101800A	a richiesta	1"x18	10	50
1N0001H102200A		1"x22	10	50
1N0001H102800A		1"x28	5	30
1N0001H123500A		1"1/4x35	-	20
1N0001H144200A		1"1/2x42	-	10
1N0001H205400A		2"x54	-	8

1N00.02**RACCORDO DIRITTO FEMMINA**
FEMALE STRAIGHT FITTING

CODICE	i	Ø	◇	☐
1N0002H020800A		1/4"x8	10	300
1N0002H031000A		3/8"x10	10	200
1N0002H031200A		3/8"x12	10	150
1N0002H031500A		3/8"x15	10	120
1N0002H040800A		1/2"x8	10	150
1N0002H041000A		1/2"x10	10	150
1N0002H041200A		1/2"x12	10	150
1N0002H041400A		1/2"x14	10	100
1N0002H041500A		1/2"x15	10	100
1N0002H041600A		1/2"x16	10	100
1N0002H041800A		1/2"x18	10	100
1N0002H042200A		1/2"x22	10	60
1N0002H051400A	a richiesta	3/4"x14	10	80
1N0002H051500A		3/4"x15	10	80
1N0002H051600A		3/4"x16	10	80
1N0002H051800A		3/4"x18	10	60
1N0002H052200A		3/4"x22	10	50
1N0002H101800A	a richiesta	1"x18	10	50
1N0002H102200A		1"x22	10	50
1N0002H102800A		1"x28	5	30
1N0002H123500A		1*1/4x35	-	20
1N0002H144200A		1*1/2x42	-	20
1N0002H205400A		2"x54	-	8

1N00.03**RACCORDO DIRITTO RIDOTTO**
REDUCED STRAIGHT FITTING

CODICE	i	Ø	◇	☐
1N0003H121000A		12x10	10	200
1N0003H151000A		15x10	10	100
1N0003H151200A		15x12	10	100
1N0003H221500A		22x15	10	60
1N0003H282200A		28x22	5	40
1N0003H351500A	a richiesta	35x15	5	-
1N0003H352200A	a richiesta	35x22	5	-

1N00.08**RACCORDO A T FEMMINA LATERALE**
SIDE FEMALE TEE

CODICE	i	Ø	◇	☐
1N0008H041515A		1/2"x15x15	10	50
1N0008H042222A		1/2"x22x22	10	30
1N0008H052222A	a richiesta	3/4"x22x22	10	20

1N00.09

RACCORDO A T AD ANGOLO
TEE ELBOW



CODICE	i	Ø	◇	☐
1N0009H151515A		15x15x15	10	50
1N0009H221515A	a richiesta	22x15x15	10	-
1N0009H222215A	a richiesta	22x22x15	5	20
1N0009H222222A	a richiesta	22x22x22	10	-

1N00.10

RACCORDO A T
TEE



CODICE	i	Ø	◇	☐
1N0010H080808A		8x8x8	10	150
1N0010H101010A		10x10x10	10	100
1N0010H121212A		12x12x12	10	100
1N0010H141414A	a richiesta	14x14x14	10	60
1N0010H151515A		15x15x15	10	60
1N0010H161616A	a richiesta	16x16x16	10	40
1N0010H181818A		18x18x18	10	50
1N0010H222222A		22x22x22	10	20
1N0010H282828A		28x28x28	5	15
1N0010H353535A		35x35x35	-	10
1N0010H424242A	a richiesta	42x42x42	-	5

1N00.12

RACCORDO A T FEMMINA
FEMALE TEE



CODICE	i	Ø	◇	☐
1N0012H120412A		12x1/2"x12	10	60
1N0012H140414A	a richiesta	14x1/2"x14	10	50
1N0012H150315A	a richiesta	15x3/8"x15	10	-
1N0012H150415A		15x1/2"x15	10	50
1N0012H160416A		16x1/2"x16	10	50
1N0012H180418A		18x1/2"x18	10	40
1N0012H180518A	a richiesta	18x3/4"x18	10	40
1N0012H220422A		22x1/2"x22	10	30
1N0012H220522A		22x3/4"x22	10	30
1N0012H280428A		28x1/2"x28	5	20
1N0012H280528A		28x3/4"x28	5	20

1N00.13RACCORDO A T RIDOTTO
REDUCED TEE

CODICE	i	Ø	◇	☐
1N0013H121512A	a richiesta	12x15x12	10	70
1N0013H151212A	a richiesta	15x12x12	10	70
1N0013H151215A	a richiesta	15x12x15	10	60
1N0013H151512A	a richiesta	15x15x12	10	60
1N0013H152215A		15x22x15	10	40
1N0013H221515A		22x15x15	10	40
1N0013H221522A		22x15x22	10	30
1N0013H222215A		22x22x15	10	30
1N0013H222822A	a richiesta	22x28x22	5	20
1N0013H281522A	a richiesta	28x15x22	5	20
1N0013H281528A		28x15x28	5	20
1N0013H282215A	a richiesta	28x22x15	5	20
1N0013H282222A	a richiesta	28x22x22	5	20
1N0013H282228A	a richiesta	28x22x28	5	20
1N0013H282815A	a richiesta	28x28x15	5	20
1N0013H282822A	a richiesta	28x28x22	5	20
1N0013H351535A	a richiesta	35x15x35	-	15
1N0013H352235A	a richiesta	35x22x35	-	10
1N0013H352835A	a richiesta	35x28x35	-	10

1N00.17RACCORDO A T MASCHIO LATERALE
SIDE MALE TEE

CODICE	i	Ø	◇	☐
1N0017H041515A	a richiesta	1/2"x15x15	10	60
1N0017H052222A		3/4"x22x22	10	20
1N0017H102828A	a richiesta	1"x28x28	5	20

1N00.20ANGOLO DOPPIO
DOUBLE ELBOW

CODICE	i	Ø	◇	☐
1N0020H080800A		8x8	10	300
1N0020H101000A		10x10	10	150
1N0020H121200A		12x12	10	100
1N0020H141400A	a richiesta	14x14	10	80
1N0020H151500A		15x15	10	100
1N0020H161600A		16x16	10	70
1N0020H181800A		18x18	10	60
1N0020H222200A		22x22	10	40
1N0020H282800A		28x28	5	20
1N0020H353500A		35x35	-	15
1N0020H424200A		42x42	-	10
1N0020H545400A		54x54	-	5

1N00.21

ANGOLO MASCHIO
MALE ELBOW



CODICE	i	Ø	◇	☐
1N0021H041000A		1/2"x10	10	120
1N0021H041200A		1/2"x12	10	120
1N0021H041400A	a richiesta	1/2"x14	10	100
1N0021H041500A		1/2"x15	10	100
1N0021H041600A	a richiesta	1/2"x16	10	60
1N0021H041800A		1/2"x18	10	60
1N0021H051200A	a richiesta	3/4"x12	10	50
1N0021H051400A	a richiesta	3/4"x14	10	50
1N0021H051500A		3/4"x15	10	50
1N0021H051600A	a richiesta	3/4"x16	10	50
1N0021H051800A		3/4"x18	10	40
1N0021H052200A		3/4"x22	10	40
1N0021H052800A		3/4"x28	5	30
1N0021H102200A		1"x22	10	40
1N0021H102800A		1"x28	5	30
1N0021H123500A	a richiesta	1"1/4x35	-	20
1N0021H144200A	a richiesta	1"1/2x42	-	10
1N0021H205400A	a richiesta	2"x54	-	5

1N00.22

ANGOLO FEMMINA
FEMALE ELBOW



CODICE	i	Ø	◇	☐
1N0022H031200A		3/8"x12	10	100
1N0022H041000A		1/2"x10	10	100
1N0022H041200A		1/2"x12	10	100
1N0022H041400A	a richiesta	1/2"x14	10	100
1N0022H041500A		1/2"x15	10	80
1N0022H041600A		1/2"x16	10	60
1N0022H041800A		1/2"x18	10	70
1N0022H051400A	a richiesta	3/4"x14	10	50
1N0022H051500A		3/4"x15	10	50
1N0022H051600A	a richiesta	3/4"x16	10	50
1N0022H051800A		3/4"x18	10	60
1N0022H052200A		3/4"x22	10	50
1N0022H102200A		1"x22	10	30
1N0022H102800A		1"x28	5	30
1N0022H123500A		1"1/4x35	-	15
1N0022H144200A	a richiesta	1"1/2x42	-	10
1N0022H205400A	a richiesta	2"x54	-	5

1N00.23 ATTACCO A MURO CON FLANGIA 3 FORI
 WALLPLATE ELBOW WITH 3 HOLES

CODICE	i	Ø	◇	☐
1N0023H041200A		1/2"x12	10	40
1N0023H041400A	a richiesta	1/2"x14	10	40
1N0023H041500A		1/2"x15	10	40
1N0023H041600A	a richiesta	1/2"x16	10	40
1N0023H042200A	a richiesta	1/2"x22	5	30
1N0023H051500A	a richiesta	3/4"x15	5	30
1N0023H052200A	a richiesta	3/4"x22	5	20

1N00.B2 ATTACCO A MURO MASCHIO
 MALE WALLPLATE ELBOW

CODICE	i	Ø	◇	☐
1N00B2H051500A	a richiesta	3/4"x15	5	30

1N00.29 ANGOLO RIDOTTO
 REDUCED ELBOW

CODICE	i	Ø	◇	☐
1N0029H121000A		12x10	10	120
1N0029H151000A	a richiesta	15x10	10	100
1N0029H151200A	a richiesta	15x12	10	100
1N0029H221500A		22x15	10	50
1N0029H282200A	a richiesta	28x22	5	30

1N00.36 CROCE
 CROSS

CODICE	i	Ø	◇	☐
1N0036H150000A		15x15x15x15	5	30
1N0036H220000A		22x22x22x22	5	20
1N0036H280000A	a richiesta	28x28x28x28	5	10

1N00.40

TAPPO MASCHIO
MALE CAP



CODICE	Ø	◇	☐
1N0040H120000A	12	10	300
1N0040H150000A	15	10	150
1N0040H220000A	22	10	80
1N0040H280000A	28	10	50
1N0040H350000A	35	-	30

1N00.70

DADO
NUT



CODICE	i	Ø
1N0070H1000A0A	a richiesta	10
1N0070R1200A0A	a richiesta	12
1N0070H1400A0A	a richiesta	14
1N0070H1500A0A		15
1N0070H1600A0A	a richiesta	16
1N0070H1800A0A	a richiesta	18
1N0070H2200A0A	a richiesta	22
1N0070H2800A0A	a richiesta	28
1N0070H3500A0A	a richiesta	35
1N0070H4200A0A	a richiesta	42
1N0070H5400A0A	a richiesta	54

1N00.81

OGIVA
OLIVE



CODICE	i	Ø	◇	☐
1N0081R100000H	a richiesta	10	25	2500
1N0081R120000H	a richiesta	12	25	1500
190081R140000H	a richiesta	14	-	2500
1N0081R150000H		15	-	2000
190081R160000H	a richiesta	16	-	2000
190081R180000H	a richiesta	18	-	1500
1N0081R220000H	a richiesta	22	-	1000
1N0081R280000H	a richiesta	28	-	500
180081R350000H	a richiesta	35	-	350
180081R420000H	a richiesta	42	-	250
180081R540000H	a richiesta	54	-	100

1800.51RIDUZIONE
REDUCTION

CODICE	i	Ø	◇	☐
180051H121001A	a richiesta	12x10	10	500
180051H151001A	a richiesta	15x10	5	350
180051H151201A	a richiesta	15x12	10	-
180051H221501A	a richiesta	22x15	10	-
180051H281501A	a richiesta	28x15	10	-
180051H282201A	a richiesta	28x22	5	100
180051H352201A	a richiesta	35x22	5	70
180051H352801A	a richiesta	35x28	-	80
180051H422801A	a richiesta	42x28	-	-
180051H543501A	a richiesta	54x35	-	25
180051H544201A	a richiesta	54x42	-	-

1N00.80ADATTATORE PER TUBO MULTISTRATO
COMPRESSION ADAPTER FOR MULTILAYER PIPE

CODICE	+	i	Ø	◇	☐
1N0080H141500A	2.0	a richiesta	15-14	10	200
1N0080H161500A	2.0	a richiesta	15-16	10	200
1N0080H202200A	2.0	a richiesta	22-20	10	120
1N0080H202201A	2.25	a richiesta	22-20	10	120
1N0080H252800A	2.5	a richiesta	28-25	5	70
1N0080H262800A	3.0	a richiesta	28-26	10	60

1N00.80 PE-X ADATTATORE PER TUBO PE-X
PE-X PIPE ADAPTER

CODICE	+	i	Ø
1N0080H121217A	1.7	a richiesta	12-12
1N0080H121220A	2.0	a richiesta	12-12
1N0080H151525A	2.5	a richiesta	15-15
1N0080H151622A	2.2	a richiesta	15-16
1N0080H181825A	2.5	a richiesta	18-18
1N0080H222230A	3.0	a richiesta	22-22

1100.94BUSSOLA DI RINFORZO
REINFORCEMENT PART

CODICE	i	Ø	◇	☐
110094H08100H	a richiesta	8x10	-	-
110094H101200H	a richiesta	10x12	50	750
110094H121400H	a richiesta	12x14	50	750
110094H141600H	a richiesta	14x16	50	600
110094H151300H	a richiesta	13x15	50	600
110094H161800H	a richiesta	16x18	50	500
110094H202200H	a richiesta	20x22	10	200

1N00.43 RACCORDO DI RIPARAZIONE
REPAIRING FITTING



CODICE	∅	◇	📦
1N0043H151500A	15x15	5	40
1N0043H222200A	22x22	5	25

1N00.30 ANGOLO ADATTATORE
ADAPTER ELBOW



CODICE	i	∅	◇	📦
1N0030H151500A	a richiesta	15x15	10	60

1N00.85 RACCORDO DIRITTO ADATTATORE PER TUBO RAME
E MULTISTRATO
STRAIGHT COMPRESSION FITTING ADAPTER FOR
COPPER AND MULTILAYER PIPE



CODICE	+	i	∅	◇	📦
1N0085H161500A	2.0	a richiesta	15-16	10	80
1N0085H202200A	2.0	a richiesta	22-20	10	50
1N0085H202201A	2.25	a richiesta	22-20	10	50



AMON

SERIE 1N00 STAGNATA LINE 1N00 TIN PLATED



Raccordi a compressione con ogiva in ottone CW617N/CW612N Compression fittings with brass olive CW617N/CW612N

I raccordi della SERIE 1N00 STAGNATA sono raccordi a compressione a tenuta completamente metallica conformi ai requisiti della norma EN1254-2.

Tutte le filettature sono conformi alla norma UNI EN 10226-1: "Filettatura di tubazioni per accoppiamento a tenuta sul filetto".

La raccorderia della Serie 1N00 STAGNATA è utilizzabile in un'ampia gamma di applicazioni per la distribuzione di acqua e di gas, sia nell'impiantistica civile che industriale.

Brass fittings belonging to LINE 1N00 TIN PLATED series feature a fully metallic body and are designed according to EN 1254-2 standard.

Threads comply with UNI EN 10226-1 law: "Piping thread for coupling on the thread".

Line 1N00 TIN PLATED fittings can be used for the supply and distribution of sanitary hot and cold water and heating and for the distribution of natural gas, both in civil and industrial installations.









VANTAGGI

- Utilizzabile per acqua sanitaria, riscaldamento, gas e solare
- Ampiezza gamma
- Tenuta metallica
- Estrema semplicità di montaggio
- Materie prime impiegate di alta qualità [UBA LIST]
- Idoneità al contatto con acqua potabile
- Grande robustezza
- Sicurezza garantita con omologazioni KIWA
- Dado di qualità SUPERIORE ricavato direttamente da barra
- Utilizzabile per tubo in rame e acciaio

ADVANTAGES



- Suitable for sanitary water, heating, gas, compressed air, solar installations.
- Wide range
- Metallic sealing
- Easy to assemble
- Raw materials complying with UBA LIST
- Suitable for drinking water
- Durability
- Guaranteed safety (KIWA certifications)
- Superior quality nut obtained directly from bar
- Suitable both for copper and inox pipe

CAMPI DI APPLICAZIONI E PRESTAZIONI FIELDS OF APPLICATION

APPLICAZIONI APPLICATIONS		T. min.	T. max	Press.max Max. pressure
	acqua potabile drinking water	-20°C	+120°C	16 bar
	acqua calda sanitaria sanitary hot water	-20°C	+120°C	16 bar
	condizionamento conditioning	-20°C	+120°C	16 bar
	radiatori radiators	-20°C	+120°C	16 bar
	irrigazione irrigation	-20°C	+120°C	16 bar
	gas gas	-20°C	+70°C	1 bar
	aria compressa compressed air	-20°C	+30°C	10 bar
	solare solar	-20°C	+200°C	9 bar
	-20°C: solo con liquido antigelo glicole in % max del 50% -20°C: with the use of glycol in a maximum percentage of 50%			

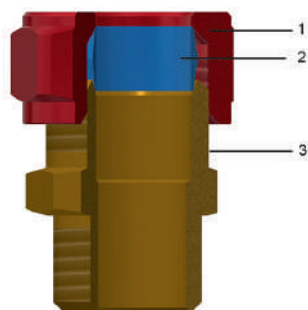
COMPONENTI E MATERIALI COMPONENTS AND MATERIALS



LEGENDA LEGEND	COMPONENTI COMPONENTS	MATERIALI MATERIALS
	1 Dado Nut	Ottone CW614N - UNI EN 12164 Brass CW614N - UNI EN 12164
	2 Ogiva Olive	Ottone CW603N - UNI EN 12164 Brass CW603N - UNI EN 12164
	3 Corpo Body	Ottone CW617N/CW612N - UNI EN 12165 Brass CW617N/CW612N - UNI EN 12165

NORMATIVE

- UNI EN 1254-2
I raccordi sono conformi alla norma UNI EN 1254-2: "Raccorderia idraulica per tubazioni rame con terminali a compressione."
- UNI EN 10226-1
Tutte le filettature sono conformi alla norma UNI EN 10226-1: "Filettatura di tubazioni per accoppiamento a tenuta sul filetto".
- D.M. 174 (06/04/2004)

REGULATIONS

- UNI EN 1254-2
Fittings comply with UNI EN 1254-2 law: "Plumbing fittings - Fittings with compression ends for use with copper tubes."
- UNI EN 10226-1
Threads comply with UNI EN 10226-1 law: "Piping thread for coupling on the thread".
- D.M. 174 (06/04/2004)
Raw materials used are of high quality and comply with the

I materiali utilizzati sono conformi al Decreto Ministeriale n° 174 del 06/04/2004 [Regolamento concernente i materiali e gli oggetti che possono essere utilizzati negli impianti fissi di captazione, trattamento, adduzione e distribuzione delle acque destinate al consumo umano].

- I raccordi vengono utilizzati con modalità e prescrizioni previste dalle vigenti normative in materia di impianti di distribuzione del gas: UNI-CIG 7129 per gas metano, UNI-CIG 7131 per gas G.P.L. e UNI-CIG 9860 criteri per la progettazione, la costruzione, il collaudo. L'impiego di raccordi a compressione con ogiva metallica per tubi di rame, è prescritto dal D.M. 12 Aprile 1996 - pubblicato sulla G.U. n° 103 del 4 Maggio 1996 - Art. 5.3.2 - comma b.
- Conforme a 4MS, UBA List (gruppo BC), DIN 50930/6 Dir. 2011/65/UE, 6C allegato III (RhOSII)
- Certificati secondo standard olandese per applicazioni gas MOP 1 bar e standard tedesco GW392 - DIN3387.

Ministerial Decree N°174 dated 06/04/2004 concerning the materials and the items used in fixed installations for water collection, treatment and supply.

- UNI-CIG 7129, UNI-CIG 7131, UNI-CIG9860
- Comply with 4MS, UBA List (BC group), DIN 50930/6 Dir. 2011/65/UE, 6C attachment III (RhOSII).
- Certified according to the Dutch Standard for gas applications MOP 1 bar and the German standard GW392 - DIN3387.

CERTIFICAZIONI CERTIFICATIONS

STATO COUNTRY	CERTIFICAZIONE CERTIFICATION	STATO COUNTRY	CERTIFICAZIONE CERTIFICATION	STATO COUNTRY	CERTIFICAZIONE CERTIFICATION
					kiwa 
					
					

TUBI COMPATIBILI

Tubi in rame per applicazioni sanitarie secondo la norma EN 1057.

Tubi in acciaio galvanizzato secondo la norma EN 10305-2 o in acciaio inossidabile conforme alla norma EN 10312.

SUITABLE PIPES

Copper pipes for sanitary installations complying with EN 1057 standard.

Galvanised steel precision tube in accordance with EN 10305-2 or stainless steel tube conforming to EN 10312.

N° GIRI DI SERRAGGIO RACCORDI PRESCRIBED NUMBER OF TIGHTENING TURNS

Diametro Diam.	Tubo Pipe	N° di giri N° turns	Tolleranza Tolerance	Coppia di chiusura Tightening
8	Cu R220	1+3/4 giro-turn	+1/4 giro-turn	20 N*m
10	Cu R220	1/2 giro-turn	+1/4 giro-turn	< 20 N*m
10	Cu R250	3/4 giro-turn	+1/4 giro-turn	20 N*m
10	Cu R290	3/4 giro-turn	+1/4 giro-turn	30 N*m
12	Cu R220	3/4 giro-turn	+1/4 giro-turn	25 N*m
12	Cu R250	3/4 giro-turn	+1/4 giro-turn	40 N*m
12	Cu R290	3/4 giro-turn	+1/4 giro-turn	40 N*m
12	Acciaio al carbonio Carbon steel	1/2 giro-turn	+1/4 giro-turn	50 N*m
15	Cu R220	3/4 giro-turn	+1/4 giro-turn	28 N*m
15	Cu R250	3/4 giro-turn	+1/4 giro-turn	40 N*m
15	Cu R290	3/4 giro-turn	+1/4 giro-turn	40 N*m
15	Acciaio al carbonio Carbon steel	1 giro-turn	+1/4 giro-turn	45 N*m
15	Acciaio INOX Stainless steel	3/4 giro-turn	+1/4 giro-turn	50 N*m
18	Cu R220	3/4 giro-turn	+1/4 giro-turn	30 N*m
18	Cu R250	3/4 giro-turn	+1/4 giro-turn	45 N*m
18	Cu R290	3/4 giro-turn	+1/4 giro-turn	45 N*m
18	Acciaio al carbonio Carbon steel	1+1/4 giro-turn	+1/4 giro-turn	140 N*m
18	Acciaio INOX Stainless steel	1+1/4 giro-turn	+1/4 giro-turn	140 N*m
22	Cu R220	3/4 giro-turn	+1/4 giro-turn	30 N*m
22	Cu R250	1/2 giro-turn	+1/4 giro-turn	45 N*m
22	Cu R290	1/2 giro-turn	+1/4 giro-turn	60 N*m
22	Acciaio al carbonio Carbon steel	1+1/4 giro-turn	+1/4 giro-turn	180 N*m
22	Acciaio INOX Stainless steel	1+1/4 giro-turn	+1/4 giro-turn	180 N*m
28	Cu R220	1/2 giro-turn	+1/4 giro-turn	40 N*m
28	Cu R290	1/2 giro-turn	+1/4 giro-turn	80 N*m
28	Acciaio al carbonio Carbon steel	1+1/4 giro-turn	+1/4 giro-turn	
28	Acciaio INOX Stainless steel	1+1/4 giro-turn	+1/4 giro-turn	
35	Cu R290	1/2 giro-turn	+1/4 giro-turn	110 N*m
35	Acciaio al carbonio Carbon steel	1 giro-turn	/	
35	Acciaio INOX Stainless steel	1 giro-turn	/	
42	Cu R290	1/2 giro-turn	+1/4 giro-turn	150 N*m
42	Acciaio al carbonio Carbon steel	1 giro-turn	/	
42	Acciaio INOX Stainless steel	1 giro-turn	/	
54	Cu R290	1/2 giro-turn	+1/4 giro-turn	190 N*m
54	Acciaio al carbonio Carbon steel	1 giro-turn	/	
54	Acciaio INOX Stainless steel	1 giro-turn	/	

ISTRUZIONI DI MONTAGGIO
ASSEMBLY INSTRUCTIONS

Utilizzando un apposito utensile taglia tubi [codice TT50.00] eseguire un taglio perpendicolare all'asse del tubo. Eliminare l'eventuale bava residua.

*Cut the pipe perpendicularly to its axis using an appropriate pipe-cutting tool [code TT500.00].
Remove possible residual burr.*

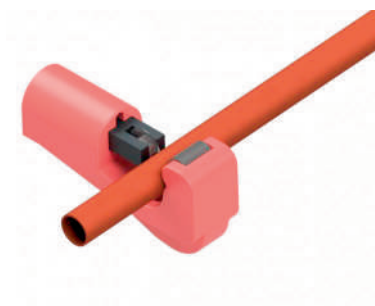

Inserire dado e ogiva sul tubo.

Insert nut and olive on the pipe.



Inserire il tubo nel corpo fino a battuta e avvitare il dado a mano, per quanto consentito.

Insert the pipe in the body until it stops and tighten the nut by hand until allowed.



Con chiave esagonale avvitare il dado fino a raggiungere il numero massimo di giri (come indicato nella precedente tabella).

With an hexagonal wrench, tighten the nut until reaching the number of threads shown in the table (previous page)



1N00.00

RACCORDO DIRITTO DOPPIO STAGNATO
DOUBLE STRAIGHT TIN PLATED



CODICE	Ø	◇	📦
1N0000J121200A	12x12	10	150
1N0000J151500A	15x15	10	100
1N0000J181800A	18x18	10	100
1N0000J222200A	22x22	10	50
1N0000J282800A	28x28	5	30
1N0000J353500A	35x35	-	20
1N0000J424200A	42x42	-	10

1N00.01

RACCORDO DIRITTO MASCHIO STAGNATO
MALE STRAIGHT TIN PLATED



CODICE	Ø	◇	📦
1N0001J031000A	3/8"x10	10	200
1N0001J031500A	3/8"x15	10	180
1N0001J041200A	1/2"x12	10	150
1N0001J041500A	1/2"x15	10	100
1N0001J041800A	1/2"x18	10	100
1N0001J042200A	1/2"x22	10	70
1N0001J051500A	3/4"x15	10	80
1N0001J051800A	3/4"x18	10	80
1N0001J052200A	3/4"x22	10	50
1N0001J052800A	3/4"x28	5	50
1N0001J102200A	1"x22	10	50
1N0001J102800A	1"x28	5	30
1N0001J123500A	1"1/4x35	-	20
1N0001J144200A	1"1/2x42	-	10
1N0001J205400A	2"x54	-	8

1N00.02 RACCORDO DIRITTO FEMMINA STAGNATO
 FEMALE STRAIGHT TIN PLATED

CODICE	Ø	◇	☐
1N0002J041200A	1/2"x12	10	150
1N0002J041500A	1/2"x15	10	100
1N0002J041800A	1/2"x18	10	100
1N0002J042200A	1/2"x22	10	60
1N0002J051500A	3/4"x15	10	80
1N0002J051800A	3/4"x18	10	70
1N0002J052200A	3/4"x22	10	50
1N0002J102200A	1"x22	10	50
1N0002J123500A	1"1/4x35	-	20
1N0002J144200A	1"1/2x42	-	20
1N0002J205400A	2"x54	-	8

1N00.03 RACCORDO DIRITTO RIDOTTO STAGNATO
 REDUCED STRAIGHT TIN PLATED

CODICE	Ø	◇	☐
1N0003J121000A	12x10	10	200
1N0003J151200A	15x12	10	100
1N0003J181500A	18x15	10	80
1N0003J221500A	22x15	10	60
1N0003J282200A	28x22	5	40

1N00.10 TEE STAGNATO
 TEE TIN PLATED

CODICE	Ø	◇	☐
1N0010J101010A	10x10x10	10	100
1N0010J121212A	12x12x12	10	100
1N0010J151515A	15x15x15	10	60
1N0010J181818A	18x18x18	10	50
1N0010J222222A	22x22x22	10	20
1N0010J282828A	28x28x28	5	15
1N0010J353535A	35x35x35	-	10
1N0010J424242A	42x42x42	-	5

1N00.12 TEE FEMMINA STAGNATO
 FEMALE TEE TIN PLATED

CODICE	Ø	◇	☐
1N0012J150415A	15x1/2"x15	10	50
1N0012J180418A	18x1/2"x18	10	40
1N0012J180518A	18x3/4"x18	10	40
1N0012J220422A	22x1/2"x22	10	30
1N0012J220522A	22x3/4"x22	10	30
1N0012J280428A	28x1/2"x28	5	20
1N0012J280528A	28x3/4"x28	5	20

1N00.13

TEE RIDOTTO STAGNATO
REDUCED TEE TIN PLATED



CODICE	Ø	◇	☐
1N0013J221522A	22x15x22	10	30
1N0013J281528A	28x15x28	5	20
1N0013J282228A	28x22x28	5	20
1N0013J352235A	35x22x35	-	10

1N00.20

ANGOLO DOPPIO STAGNATO
DOUBLE ELBOW TIN PLATED



CODICE	Ø	◇	☐
1N0020J121200A	12x12	10	100
1N0020J151500A	15x15	10	100
1N0020J181800A	18x18	10	60
1N0020J222200A	22x22	10	40
1N0020J282800A	28x28	5	20
1N0020J353500A	35x35	-	15
1N0020J424200A	42x42	-	10

1N00.21

ANGOLO MASCHIO STAGNATO
MALE ELBOW TIN PLATED



CODICE	Ø	◇	☐
1N0021J041500A	1/2"x15	10	100
1N0021J041800A	1/2"x18	10	60
1N0021J042200A	1/2"x22	10	50
1N0021J051500A	3/4"x15	10	50
1N0021J051800A	3/4"x18	10	50
1N0021J052200A	3/4"x22	10	40
1N0021J052800A	3/4"x28	5	30
1N0021J102200A	1"x22	10	40
1N0021J102800A	1"x28	5	30

1N00.22 ANGOLO FEMMINA STAGNATO
FEMALE ELBOW TIN PLATED

CODICE	Ø	◇	☐
1N0022J041500A	1/2"x15	10	80
1N0022J041800A	1/2"x18	10	70
1N0022J042200A	1/2"x22	10	50
1N0022J051500A	3/4"x15	10	50
1N0022J051800A	3/4"x18	10	60
1N0022J052200A	3/4"x22	10	50
1N0022J052800A	3/4"x28	5	30
1N0022J102200A	1"x22	5	30
1N0022J102800A	1"x28	5	30
1N0022J123500A	1"1/4x35	-	15
1N0022J144200A	1"1/2x42	-	10

1N00.23 ATTACCO A MURO STAGNATO
WALLPLATE ELBOW TIN PLATED

CODICE	Ø	◇	☐
1N0023J041500A	1/2"x15	10	40
1N0023J042200A	1/2"x22	5	30
1N0023J052200A	3/4"x22	5	20

1N00.29 ANGOLO RIDOTTO STAGNATO
REDUCED DOUBLE ELBOW TIN PLATED

CODICE	Ø	◇	☐
1N0029J221500A	22x15	10	50
1N0029J282200A	28x22	5	30

1N00.40 TAPPO MASCHIO STAGNATO
MALE CAP TIN PLATED

CODICE	Ø	◇	☐
1N0040J150000A	15	10	150
1N0040J180000A	18	10	150
1N0040J220000A	22	10	80

 **GENERAL
FITTINGS**
YOUNIQUE · ITALIAN

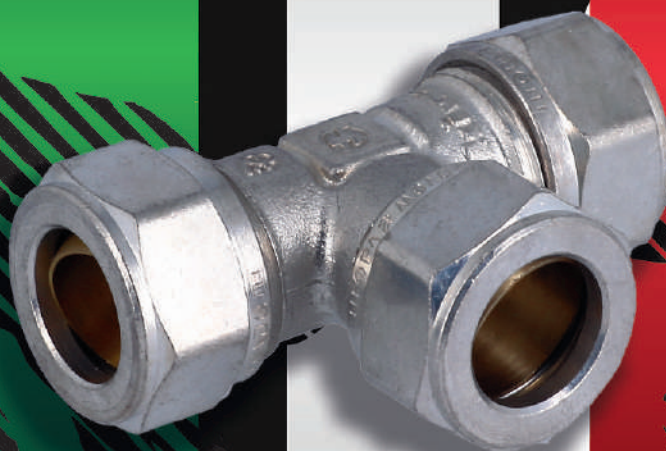

AMON

1N00 STAGNATA-1N00 TIN PLATED
RACCORDI A COMPRESIONE
CON OGIVA IN OTTONE
COMPRESSION FITTINGS WITH BRASS OLIVE



AMON

SERIE 1N00 DZR LINE 1N00 DZR



Raccordi a compressione con ogiva in ottone CW625N

Compression fittings with brass olive in CW625N

I raccordi della SERIE 1N00 sono raccordi a compressione a tenuta completamente metallica conformi ai requisiti della norma EN1254-2.

Tutte le filettature sono conformi alla norma UNI EN 10226-1: "Filettatura di tubazioni per accoppiamento a tenuta sul filetto".

La raccorderia della Serie 1N00 è utilizzabile in un'ampia gamma di applicazioni per la distribuzione di acqua, sia nell'impiantistica civile che industriale.

Brass fittings belonging to LINE 1N00 series feature a fully metallic body and are designed according to EN 1254-2 standard.

Threads comply with UNI EN 10226-1 law: "Piping thread for coupling on the thread".

Line 1N00 fittings can be used for the supply and distribution of sanitary hot and cold water and heating, both in civil and industrial installations.









VANTAGGI

- Utilizzabile per acqua sanitaria, riscaldamento, solare, aria compressa
- Ampiezza gamma
- Tenuta metallica
- Estrema semplicità di montaggio
- Materie prime impiegate di alta qualità [UBA LIST]
- Idoneità al contatto con acqua potabile
- Grande robustezza
- Resistenza alla dezincificazione
- Dado di qualità SUPERIORE ricavato direttamente da barra
- Utilizzabile per tubo in rame e acciaio
- Disponibile in versione cromata

ADVANTAGES



- Suitable for sanitary water, heating, and solar installations
- Wide range
- Metallic sealing
- Easy to assemble
- Raw materials complying with UBA LIST
- Suitable for drinking water
- Durability
- Resistance to dezincification
- Superior quality nut obtained directly from bar
- Suitable both for copper and inox pipe
- Available in chrome version

CAMPI DI APPLICAZIONI E PRESTAZIONI FIELDS OF APPLICATION

APPLICAZIONI APPLICATIONS		T. min.	T. max	Press.max Max. pressure
	acqua potabile drinking water	-20°C	+120°C	16 bar
	acqua calda sanitaria sanitary hot water	-20°C	+120°C	16 bar
	condizionamento conditioning	-20°C	+120°C	16 bar
	radiatori radiators	-20°C	+120°C	16 bar
	irrigazione irrigation	-20°C	+120°C	16 bar
	aria compressa compressed air	-20°C	+30°C	10 bar
	solare solar	-20°C	+200°C	9 bar
	-20°C: solo con liquido antigelo glicole in % max del 50% -20°C: with the use of glycol in a maximum percentage of 50%			

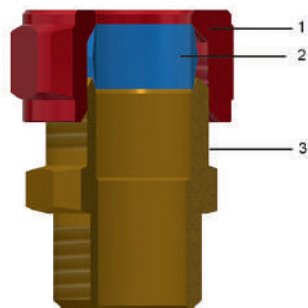
COMPONENTI E MATERIALI COMPONENTS AND MATERIALS



LEGENDA LEGEND	COMPONENTI COMPONENTS	MATERIALI MATERIALS
	1 Dado Nut	Ottone CW614N - UNI EN 12164 Brass CW614N - UNI EN 12164
	2 Ogiva Olive	Ottone CW603N - UNI EN 12164 Brass CW603N - UNI EN 12164
	3 Corpo Body	Ottone CW625N-UNI EN 12165 Brass CW625N-UNI EN 12165

TUBI COMPATIBILI

Tubi in rame per applicazioni sanitarie secondo la norma EN 1057.

Tubi in acciaio galvanizzato secondo la norma EN 10305-2 o in acciaio inossidabile conforme alla norma EN 10312.

SUITABLE PIPES

Copper pipes for sanitary installations complying with EN 1057 standard.

Galvanised steel precision tube in accordance with EN 10305-2 or stainless steel tube conforming to EN 10312.

N° GIRI DI SERRAGGIO RACCORDI PRESCRIBED NUMBER OF TIGHTENING TURNS

Ø	Tubo Pipe	N° di giri N° turns	Tolleranza Tolerance	Coppia di chiusura Tightening
8	Cu R220	1+3/4 giro-turn	+1/4 giro-turn	20 N*m
10	Cu R220	1/2 giro-turn	+1/4 giro-turn	< 20 N*m
10	Cu R250	3/4 giro-turn	+1/4 giro-turn	20 N*m
10	Cu R290	3/4 giro-turn	+1/4 giro-turn	30 N*m
12	Cu R220	3/4 giro-turn	+1/4 giro-turn	25 N*m
12	Cu R250	3/4 giro-turn	+1/4 giro-turn	40 N*m
12	Cu R290	3/4 giro-turn	+1/4 giro-turn	40 N*m
12	Acciaio al carbonio Carbon steel	1/2 giro-turn	+1/4 giro-turn	50 N*m
15	Cu R220	3/4 giro-turn	+1/4 giro-turn	28 N*m
15	Cu R250	3/4 giro-turn	+1/4 giro-turn	40 N*m
15	Cu R290	3/4 giro-turn	+1/4 giro-turn	40 N*m
15	Acciaio al carbonio Carbon steel	1 giro-turn	+1/4 giro-turn	45 N*m
15	Acciaio INOX Stainless steel	3/4 giro-turn	+1/4 giro-turn	50 N*m
18	Cu R220	3/4 giro-turn	+1/4 giro-turn	30 N*m
18	Cu R250	3/4 giro-turn	+1/4 giro-turn	45 N*m
18	Cu R290	3/4 giro-turn	+1/4 giro-turn	45 N*m
18	Acciaio al carbonio Carbon steel	1+1/4 giro-turn	+1/4 giro-turn	140 N*m
18	Acciaio INOX Stainless steel	1+1/4 giro-turn	+1/4 giro-turn	140 N*m
22	Cu R220	3/4 giro-turn	+1/4 giro-turn	30 N*m
22	Cu R250	1/2 giro-turn	+1/4 giro-turn	45 N*m
22	Cu R290	1/2 giro-turn	+1/4 giro-turn	60 N*m
22	Acciaio al carbonio Carbon steel	1+1/4 giro-turn	+1/4 giro-turn	180 N*m
22	Acciaio INOX Stainless steel	1+1/4 giro-turn	+1/4 giro-turn	180 N*m
28	Cu R220	1/2 giro-turn	+1/4 giro-turn	40 N*m
28	Cu R290	1/2 giro-turn	+1/4 giro-turn	80 N*m
28	Acciaio al carbonio Carbon steel	1+1/4 giro-turn	+1/4 giro-turn	
28	Acciaio INOX Stainless steel	1+1/4 giro-turn	+1/4 giro-turn	
35	Cu R290	1/2 giro-turn	+1/4 giro-turn	110 N*m
35	Acciaio al carbonio Carbon steel	1 giro-turn	/	
35	Acciaio INOX Stainless steel	1 giro-turn	/	
42	Cu R290	1/2 giro-turn	+1/4 giro-turn	150 N*m
42	Acciaio al carbonio Carbon steel	1 giro-turn	/	
42	Acciaio INOX Stainless steel	1 giro-turn	/	
54	Cu R290	1/2 giro-turn	+1/4 giro-turn	190 N*m
54	Acciaio al carbonio Carbon steel	1 giro-turn	/	
54	Acciaio INOX Stainless steel	1 giro-turn	/	

NORMATIVE

- UNI EN 1254-2
I raccordi sono conformi alla norma UNI EN 1254-2: "Raccorderia idraulica per tubazioni rame con terminali a compressione."
- UNI EN 10226-1
Tutte le filettature sono conformi alla norma UNI EN 10226-1: "Filettatura di tubazioni per accoppiamento a tenuta sul filetto".
- D.M. 174 (06/04/2004)
I materiali utilizzati sono conformi al Decreto Ministeriale n° 174 del 06/04/2004 [Regolamento concernente i materiali e gli oggetti che possono essere utilizzati negli impianti fissi di captazione, trattamento, adduzione e distribuzione delle acque destinate al consumo umano].
- Conforme a 4MS, UBA List (gruppo BC), DIN 50930/6 Dir. 2011/65/UE, 6C allegato III (RhOSII)
- Certificati secondo standard olandese per applicazioni gas MOP 1 bar e standard tedesco GW392 - DIN3387.

REGULATIONS

- UNI EN 1254-2
Fittings comply with UNI EN 1254-2 law: "Plumbing fittings - Fittings with compression ends for use with copper tubes."
- UNI EN 10226-1
Threads comply with UNI EN 10226-1 law: "Piping thread for coupling on the thread".
- D.M. 174 (06/04/2004)
Raw materials used are of high quality and comply with the Ministerial Decree N°174 dated 06/04/2004 concerning the materials and the items used in fixed installations for water collection, treatment and supply.
- Comply with 4MS, UBA List (BC group), DIN 50930/6 Dir. 2011/65/UE, 6C attachment III (RhOSII).
- Certified according to the Dutch Standard for gas applications MOP 1 bar and the German standard GW392 - DIN3387.

ISTRUZIONI DI MONTAGGIO ASSEMBLY INSTRUCTIONS

Utilizzando un apposito utensile taglia tubi [codice TT50.00] eseguire un taglio perpendicolare all'asse del tubo. Eliminare l'eventuale bava residua.

*Cut the pipe perpendicularly to its axis using an appropriate pipe-cutting tool [code TT500.00].
Remove possible residual burr.*

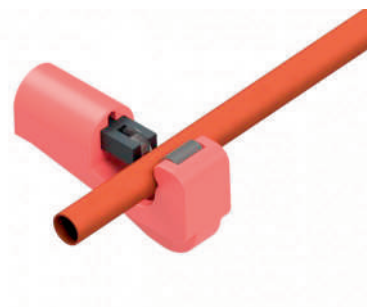

Inserire dado e ogiva sul tubo.

Insert nut and olive on the pipe.

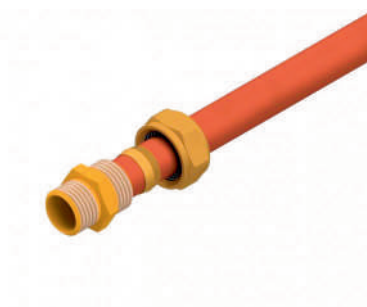

Inserire il tubo nel corpo fino a battuta e avvitare il dado a mano, per quanto consentito.

Insert the pipe in the body until it stops and tighten the nut by hand until allowed.

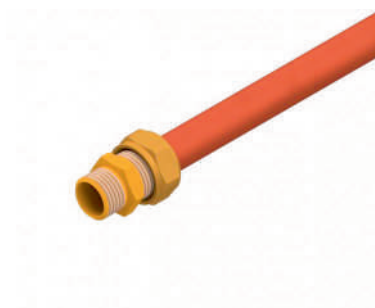

Con chiave esagonale avvitare il dado fino a raggiungere il numero massimo di giri (come indicato nella precedente tabella).

With an hexagonal wrench, tighten the nut until reaching the number of threads shown in the table (previous page)



1N00.00 RACCORDO DIRITTO DOPPIO
DOUBLE STRAIGHT FITTING



CODICE	Ø	◇	☐
1N0000W101000A	10x10	10	200
1N0000W121200A	12x12	10	150
1N0000W151500A	15x15	10	100
1N0000W181800A	18x18	10	100
1N0000W222200A	22x22	10	50
1N0000W282800A	28x28	5	30
1N0000W353500A	35x35	-	20
1N0000W424200A	42x42	-	10
1N0000W545400A	54x54	-	5

1N00.00.C RACCORDO DIRITTO DOPPIO CROMATO
DOUBLE CHROME-PLATED STRAIGHT FITTING



CODICE	Ø	◇	☐
1N0000Y101000A	10x10	10	200
1N0000Y121200A	12x12	10	150
1N0000Y151500A	15x15	10	100
1N0000Y181800A	18x18	10	100
1N0000Y222200A	22x22	10	50

1N00.01 RACCORDO DIRITTO MASCHIO
MALE STRAIGHT FITTING



CODICE	Ø	◇	☐
1N0001W020800A	1/4"x8	10	300
1N0001W031000A	3/8"x10	10	200
1N0001W031200A	3/8"x12	10	200
1N0001W031500A	3/8"x15	10	180
1N0001W040800A	1/2"x8	10	150
1N0001W041000A	1/2"x10	10	150
1N0001W041200A	1/2"x12	10	150
1N0001W041500A	1/2"x15	10	100
1N0001W041600A	1/2"x16	10	100
1N0001W041800A	1/2"x18	10	100
1N0001W042200A	1/2"x22	10	70
1N0001W051500A	3/4"x15	10	80
1N0001W051800A	3/4"x18	10	70
1N0001W052200A	3/4"x22	10	50
1N0001W052800A	3/4"x28	5	50
1N0001W102200A	1"x22	10	50
1N0001W102800A	1"x28	5	30
1N0001W103500A	1"x35	-	-
1N0001W123500A	1"1/4x35	-	20
1N0001W144200A	1"1/2x42	-	10
1N0001W205400A	2"x54	-	8

1N00.01.CRACCORDO DIRITTO MASCHIO CROMATO
CHROME-PLATED MALE STRAIGHT FITTING

CODICE	Ø	◇	📦
1N0001Y031200A	3/8"x10	10	200
1N0001Y041000A	1/2"x10	10	150
1N0001Y041200A	1/2"x12	10	150
1N0001Y041500A	1/2"x15	10	100
1N0001Y052200A	3/4"x22	10	50

1N00.02RACCORDO DIRITTO FEMMINA
FEMALE STRAIGHT FITTING

CODICE	Ø	◇	📦
1N0002W031000A	3/8"x10	10	200
1N0002W031200A	3/8"x12	10	150
1N0002W031500A	3/8"x15	10	120
1N0002W041000A	1/2"x10	10	150
1N0002W041200A	1/2"x12	10	150
1N0002W041500A	1/2"x15	10	100
1N0002W041600A	1/2"x16	10	100
1N0002W041800A	1/2"x18	10	100
1N0002W042200A	1/2"x22	10	60
1N0002W051500A	3/4"x15	10	80
1N0002W052200A	3/4"x22	10	50
1N0002W102200A	1"x22	10	50
1N0002W102800A	1"x28	5	30
1N0002W123500A	1"1/4x35	-	20
1N0002W144200A	1"1/2x42	-	20
1N0002W205400A	2"x54	-	8

1N00.02.C RACCORDO DIRITTO FEMMINA CROMATO
CHROME-PLATED FEMALE STRAIGHT FITTING



CODICE	Ø	◇	☐
1N0002Y031200A	3/8"x10	10	150
1N0002Y041000A	1/2"x10	10	150
1N0002Y041200A	1/2"x12	10	150
1N0002Y041500A	1/2"x15	10	100

1N00.03 RACCORDO DIRITTO DOPPIO
DOUBLE STRAIGHT FITTING



CODICE	Ø	◇	☐
1N0003W100800A	10x8	10	250
1N0003W120800A	12x8	10	250
1N0003W121000A	12x10	10	200
1N0003W151000A	15x10	10	100
1N0003W151200A	15x12	10	100
1N0003W161500A	16x15	10	80
1N0003W181200A	18x12	10	80
1N0003W181500A	18x15	10	80
1N0003W221500A	22x15	10	60

1N00.03.C RACCORDO DIRITTO DOPPIO CROMATO
DOUBLE CHROME-PLATED STRAIGHT FITTING



CODICE	Ø	◇	☐
1N0003Y100800A	10x8	10	250
1N0003Y120800A	12x8	10	250
1N0003Y121000A	12x10	10	200
1N0003Y151000A	15x10	10	100
1N0003Y151200A	15x12	10	100

1N00.10 RACCORDO A T
TEE



CODICE	Ø	◇	☐
1N0010W101010A	10x10x10	10	100
1N0010W121212A	12x12x12	10	100
1N0010W151515A	15x15x15	10	60
1N0010W181818A	18x18x18	10	50
1N0010W222222A	22x22x22	10	20
1N0010W282828A	28x28x28	5	15
1N0010W353535A	35x35x35	-	10
1N0010W424242A	42x42x42	-	5
1N0010W545454A	54x54x54	-	3

1N00.10.C RACCORDO A T CROMATO
CHROME-PLATED TEE

CODICE	Ø	◇	📦
1N0010Y101010A	10	10	100
1N0010Y121212A	12	10	100
1N0010Y151515A	15	10	60
1N0010Y181818A	18	10	50
1N0010Y222222A	22	10	20

1N00.11 RACCORDO A T MASCHIO
MALE TEE

CODICE	Ø	◇	📦
1N0011W150415A	15x1/2"x15	10	50

1N00.12 RACCORDO A T FEMMINA
FEMALE TEE

CODICE	Ø	◇	📦
1N0012W120412A	12x1/2"x12	10	60
1N0012W150315A	15x3/8"x15	10	50
1N0012W150415A	15x1/2"x15	10	50
1N0012W180418A	18x1/2"x18	10	40
1N0012W220422A	22x1/2"x22	10	30
1N0012W220522A	22x3/4"x22	10	30

1N00.13

RACCORDO A T RIDOTTO
REDUCED TEE



CODICE	Ø	◇	☐
1N0013W121012A	12x10x12	10	100
1N0013W121512A	12x15x12	10	70
1N0013W151015A	15x10x15	10	60
1N0013W151212A	15x12x12	10	70
1N0013W151215A	15x12x15	10	60
1N0013W151512A	15x15x12	10	60
1N0013W152215A	15x22x15	10	40
1N0013W161516A	16x15x16	10	40
1N0013W181215A	18x12x15	10	15
1N0013W181518A	18x15x18	10	50
1N0013W221222A	22x12x22	10	30
1N0013W221515A	22x15x15	10	40
1N0013W221522A	22x15x22	10	30
1N0013W222215A	22x22x15	10	30
1N0013W281528A	28x15x28	5	20
1N0013W282222A	28x22x22	5	20
1N0013W282815A	28x28x15	5	20

1N00.13.C

RACCORDO A T RIDOTTO CROMATO
CHROME-PLATED REDUCED TEE



CODICE	Ø	◇	☐
1N0013Y121012A	12X10X12	10	100
1N0013Y121512A	12X15X12	10	70
1N0013Y151212A	15X12X12	10	70
1N0013Y151215A	15X12X15	10	60
1N0013Y151512A	15X15X12	10	60
1N0013Y181218A	18X12X18	10	50
1N0013Y181518A	18X15X18	10	50
1N0013Y221515A	22X15X15	10	40
1N0013Y221522A	22X15X22	10	30
1N0013Y222215A	22X22X15	10	30

1N00.20 ANGOLO DOPPIO
DOUBLE ELBOW

CODICE	Ø	◇	☐
1N0020W101000A	10x10	10	150
1N0020W121200A	12x12	10	100
1N0020W151500A	15x15	10	100
1N0020W181800A	18x18	10	60
1N0020W222200A	22x22	10	40
1N0020W282800A	28x28	5	20
1N0020W353500A	35x35	-	15
1N0020W424200A	42x42	-	10
1N0020W545400A	54x54	-	5

1N00.20.C ANGOLO DOPPIO CROMATO
CHROME-PLATED DOUBLE ELBOW

CODICE	Ø	◇	☐
1N0020Y101000A	10x10	10	150
1N0020Y121200A	12x12	10	100
1N0020Y151500A	15x15	10	100
1N0020Y181800A	18x18	10	60
1N0020Y222200A	22x22	10	40

1N00.21 ANGOLO MASCHIO
MALE ELBOW

CODICE	Ø	◇	☐
1N0021W031200A	3/8"x12	10	150
1N0021W031500A	3/8"x15	10	100
1N0021W041000A	1/2"x10	10	120
1N0021W041200A	1/2"x12	10	120
1N0021W041500A	1/2"x15	10	100
1N0021W041800A	1/2"x18	10	60
1N0021W042200A	1/2"x22	10	50
1N0021W051500A	3/4"x15	10	50
1N0021W051800A	3/4"x18	10	40
1N0021W052200A	3/4"x22	10	40
1N0021W102800A	1"x28	5	30
1N0021W123500A	1"1/4x35	-	20
1N0021W144200A	1"1/2x42	-	10

1N00.21.C ANGOLO MASCHIO CROMATO
CHROME-PLATED MALE ELBOW

CODICE	Ø	◇	☐
1N0021Y031200A	3/8"x12	10	150
1N0021Y041200A	1/2"x12	10	120
1N0021Y041500A	1/2"x15	10	100

1N00.22 ANGOLO FEMMINA
FEMALE ELBOW



CODICE	Ø	◇	☐
1N0022W031200A	3/8"x12	10	100
1N0022W041200A	1/2"x12	10	100
1N0022W041500A	1/2"x15	10	80
1N0022W041800A	1/2"x18	10	70
1N0022W052200A	3/4"x22	10	50
1N0022W102800A	1"x28	5	30
1N0022W123500A	1"1/4x35	-	15
1N0022W144200A	1"1/2x42	-	10
1N0022W205400A	2"x54	-	5

1N00.22.C ANGOLO FEMMINA CROMATO
CHROME-PLATED FEMALE ELBOW



CODICE	Ø	◇	☐
1N0022Y031200A	3/8"x12	10	100
1N0022Y041200A	1/2"x12	10	100
1N0022Y041500A	1/2"x15	10	80

1N00.23 ATTACCO A MURO CON FLANGIA 3 FORI
WALLPLATE ELBOW WITH 3 HOLES



CODICE	Ø	◇	☐
1N0023W041500A	15x1/2"x15	10	40

1N00.23.C ATTACCO A MURO CROMATO CON FLANGIA 3 FORI
CHROME-PLATED WALLPLATE ELBOW WITH 3 HOLES



CODICE	Ø	◇	☐
1N0023Y041200A	1/2"x12	10	40
1N0023Y041500A	1/2"x15	10	40

1N00.29 ANGOLO RIDOTTO
REDUCED ELBOW



CODICE	Ø	◇	☐
1N0029W151200A	15x12	10	100
1N0029W161500A	16x15	10	70
1N0029W221500A	22x15	10	50

1N00.29.C ANGOLO RIDOTTO CROMATO
CHROME PLATED REDUCED ELBOW



CODICE	Ø	◇	📦
1N0029Y151200A	15x12	10	100

1N00.43 RACCORDO DI RIPARAZIONE
REPAIRING FITTING



CODICE	Ø	◇	📦
1N0043W151500A	15x15	5	40
1N0043W222200A	22x22	5	25

1N00.70 DADO
NUT



CODICE	Ø	📦
1N0070H1000A0A	10	500
1N0070R1200A0A	12	1000
1N0070H1500A0A	15	500
1N0070H1600A0A	16	500
1N0070H1800A0A	18	400
1N0070H2200A0A	22	300
1N0070H2800A0A	28	150
1N0070H3500A0A	35	100
1N0070H4200A0A	42	50
1N0070H5400A0A	54	40

1N00.70.C DADO CROMATO
CHROME-PLATED NUT



CODICE	Ø	📦
1N0070C100000A	10	1000
1N0070C120000A	12	1000
1N0070C150000A	15	500
1N0070C180000A	18	400
1N0070C220000A	22	300

1N00.40

TAPPO MASCHIO
MALE CAP



CODICE	Ø	◇	☐
1N0040W100000A	10	10	300
1N0040W120000A	12	10	300
1N0040W150000A	15	10	150
1N0040W180000A	18	10	150
1N0040W220000A	22	10	80
1N0040W280000A	28	10	50

1800.51

RIDUZIONE
REDUCTION



CODICE	Ø	◇	☐
180051W100801A	10x8	10	500
180051W120801A	12x8	10	500
180051W121001A	12x10	10	500
180051W150801A	15x8	10	350
180051W151001A	15x10	10	350
180051W151201A	15x12	10	350
180051W181201A	18x12	10	250
180051W181501A	18x15	10	250
180051W181601A	18x16	10	250
180051W221201A	22x12	10	200
180051W221501A	22x15	10	200
180051W221801A	22x18	10	200
180051W281201A	28x12	10	50
180051W281501A	28x15	10	150
180051W282201A	28x22	10	150
180051W352201A	35x22	10	80
180051W352801A	35x28	10	80
180051W422801A	42x28	5	50
180051W423501A	42x35	5	50
180051W423601A	42x36	5	50
180051W543501A	54x35	-	25
180051W544201A	54x42	-	25

1800.C1

TAPPO INTERNO
INNER CAP



CODICE	Ø	◇	☐
1800C1W100000H	10	10	1500
1800C1W120000H	12	10	1500
1800C1W150000H	15	10	600
1800C1W180000H	18	10	500
1800C1W220000H	22	10	400
1800C1W280000H	28	10	350
1800C1W350000H	35	10	200
1800C1W420000H	42	10	150
1800C1W540000H	54	5	100

1N00.81

OGIVA
OLIVE



CODICE	Ø	◇	☐
1N0081R100000H	10	25	2500
1N0081R120000H	12	25	1500
1N0081R150000H	15	-	2000
190081R160000H	16	-	2000
190081R180000H	18	-	1500
1N0081R220000H	22	-	1000
1N0081R280000H	28	-	500
180081R350000H	35	-	350
180081R420000H	42	-	250
180081R540000H	54	-	100

1N00.B6

ANGOLO DOPPIO CON SFIATO
DOUBLE ELBOW WITH VENT



CODICE	Ø	◇
1N00B6W151500A	15	10
1N00B6W222200A	22	10

1N00.B5 ANGOLO DOPPIO CON SCARICO
DOUBLE ELBOW WITH OUTPUT



CODICE	Ø	◇	☐
1N00B5W151500A	15	10	-
1N00B5W222200A	22	10	40

1N00.74 SFIATO
VENTING



CODICE	Ø	◇
1N0074W150000A	15	10



HORUS

SERIE 1200

LINE 1200



Raccordi a compressione con tenuta O-Ring

Compression fittings with O-Ring

La serie 1200 è costituita da raccordi a compressione in ottone con anello di serraggio ed O-ring di tenuta realizzata in conformità ai requisiti della norma EN 1254-2.

I raccordi sono utilizzabili per l'adduzione di acqua calda e fredda in impianti idrico-sanitari e di riscaldamento. Sono adatti a tutte le tipologie di tubo in rame conforme alla norma EN 1057.

Le filettature sono conformi alla UNI EN ISO 228-1:2003 "Filettatura di tubazioni per accoppiamento non a tenuta sul filetto".

Brass fittings of LINE 1200 feature a metallic compression ring and rubber seal, and are designed according to EN 1254-2 standard.

They are suitable for cold and hot water supply for sanitary and heating systems. Copper pipes to be used must comply with EN 1057 standard.

Threads complies with UNI EN ISO 228-1 law: "Piping thread for coupling not with tightness on the thread".





VANTAGGI

- Estrema semplicità di montaggio
- Completa smontabilità dei pezzi
- Idoneità al contatto con acqua potabile
- Materie prime impiegate di alta qualità [UBA LIST]

ADVANTAGES



- *Easy to assemble*
- *Parts can be completely disassembled*
- *Suitable for drinking water*
- *Raw materials complying with UBA LIST*

CAMPI DI APPLICAZIONI E PRESTAZIONI FIELDS OF APPLICATION

APPLICAZIONI APPLICATIONS		T. min.	T. max	Press.max Max. pressure
	acqua potabile drinking water	-20°C	+120°C	10 bar
	acqua calda sanitaria sanitary hot water	-20°C	+120°C	10 bar
	aria compressa compressed air	-20°C	+120°C	10 bar
	radiatori radiators	-20°C	+120°C	10 bar
	-20°C: solo con liquido antigelo glicole in % max del 50% -20°C: with the use of glycol in a maximum percentage of 50%			

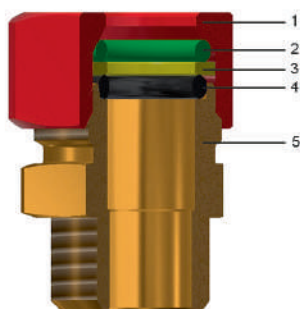
COMPONENTI E MATERIALI COMPONENTS AND MATERIALS



LEGENDA LEGEND	COMPONENTI COMPONENTS	MATERIALI MATERIALS
	1 Dado Nut	Ottone CW617N - UNI EN 12165 Brass CW617N - UNI EN 12165
	2 Anello elastico Metal tightness component	Ottone CW508L - UNI EN 12166 Brass CW508L - UNI EN 12166
	3 Rondella Flat ring	Ottone CW508L - UNI EN 12166 Brass CW508L - UNI EN 12166
	4 O-Ring	Elastomero per acqua potabile Elastomer for drinking water
	5 Corpo Body	Ottone CW617N - UNI EN 12165 Brass CW617N - UNI EN 12165

TUBI COMPATIBILI

Tubi in rame per applicazioni sanitarie secondo la norma EN 1057.

SUITABLE PIPES

Copper pipes for sanitary installations complying with EN 1057 standard.

FILETTATURA E SERRAGGIO DADI THREADS AND NUTS TIGHTENING

Ø	Attacco filetto Thread coupling	N° Giri (+1/4) N° Turns (+1/4)
Ø10	M18 x 1.5	1/4
Ø12	M21 x 1.5	1/4
Ø14	M23 x 1.5	1/4
Ø16	M25 x 1.5	1/4
Ø18	M27 x 1.5	1/4
Ø22	M33 x 1.5	1/4
Ø28	M38 x 1.5	1/4

NORMATIVE

- UNI EN 1254-2
I raccordi sono conformi alla norma UNI EN 1254-2: "Raccorderia idraulica per tubazioni rame con terminali a compressione."
- UNI EN ISO 228-1:2003
Tutte le filettature sono conformi alla norma UNI EN ISO 228-1:2003: "Filettatura di tubazioni per accoppiamento non a tenuta sul filetto".
- D.M. 174 (06/04/2004)
I materiali utilizzati sono conformi al Decreto Ministeriale n° 174 del 06/04/2004 [Regolamento concernente i materiali e gli oggetti che possono essere utilizzati negli impianti fissi di captazione, trattamento, adduzione e distribuzione delle acque destinate al consumo umano].
- Conforme a 4MS, UBA List (gruppo BC), DIN 50930/6 Dir. 2011/65/UE, 6C allegato III (RhOSII)

REGULATIONS

- UNI EN 1254-2
Fittings comply with UNI EN 1254-2 law: "Plumbing fittings - Fittings with compression ends for use with copper tubes."
- UNI EN ISO 228-1:2003
Threads complies with UNI EN ISO 228-1:2003 law: "Piping thread for coupling not with tightness on the thread".
- D.M. 174 (06/04/2004)
Raw materials used are of high quality and comply with the Ministerial Decree N°174 dated 06/04/2004 concerning the materials and the items used in fixed installations for water collection, treatment and supply.
- Comply with 4MS, UBA List (BC group), DIN 50930/6 Dir. 2011/65/UE, 6C attachment III (RhOSII).

CERTIFICAZIONI CERTIFICATIONS

STATO COUNTRY	CERTIFICAZIONE CERTIFICATION	STATO COUNTRY	CERTIFICAZIONE CERTIFICATION	STATO COUNTRY	CERTIFICAZIONE CERTIFICATION
					
					

ISTRUZIONI DI MONTAGGIO ASSEMBLY INSTRUCTIONS

Utilizzando un apposito utensile taglia tubi [codice TT50.00] eseguire un taglio perpendicolare all'asse del tubo. Eliminare l'eventuale bava residua.

Cut the pipe perpendicularly to its axis using an appropriate pipe-cutting tool [code TT500.00]. Remove possible residual burr.

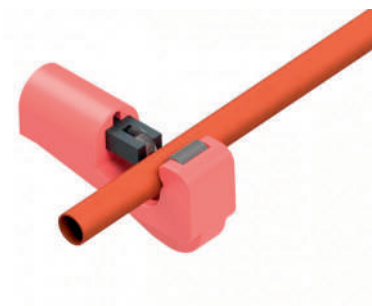

Inserire dado, anello, rondella e O-Ring sul tubo.

Insert nut, ring, washer and O-Ring on the pipe.

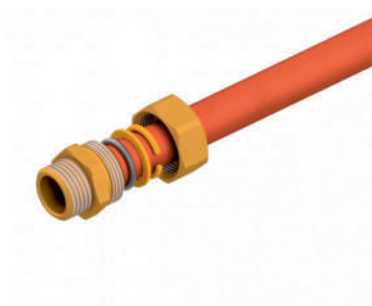

Posizionare il tubo nel corpo spingendo gli elementi nella sede O-Ring.

Locate the pipe into the body pushing the elements in the O-Ring seat.



Con chiave esagonale avvitare il dado fino a raggiungere il numero massimo di giri (come indicato nella precedente tabella).

With an hexagonal wrench, tighten the nut until reaching the number of threads shown in the table (previous page)



1200.00RACCORDO DIRITTO DOPPIO
DOUBLE STRAIGHT FITTING

CODICE	Ø	◇	☐
120000H101000A	10x10	10	150
120000H121200A	12x12	10	150
120000H141400A	14x14	10	100
120000H161600A	16x16	10	80
120000H181800A	18x18	10	80
120000H222200A	22x22	10	50
120000H282800A	28x28	5	30

1200.01RACCORDO DIRITTO MASCHIO
MALE STRAIGHT FITTING

CODICE	Ø	◇	☐
120001H031000A	3/8"x10	10	250
120001H031200A	3/8"x12	10	250
120001H031400A	3/8"x14	10	120
120001H031600A	3/8"x16	10	120
120001H041000A	1/2"x10	10	200
120001H041200A	1/2"x12	10	200
120001H041400A	1/2"x14	10	120
120001H041600A	1/2"x16	10	120
120001H041800A	1/2"x18	10	120
120001H042200A	1/2"x22	10	70
120001H051200A	3/4"x12	10	120
120001H051400A	3/4"x14	10	120
120001H051600A	3/4"x16	10	100
120001H051800A	3/4"x18	10	90
120001H052200A	3/4"x22	10	60
120001H052800A	3/4"x28	10	50
120001H101800A	1"x18	10	70
120001H102200A	1"x22	10	60
120001H102800A	1"x28	5	40

1200.02

RACCORDO DIRITTO FEMMINA
FEMALE STRAIGHT FITTING



CODICE	Ø	◇	☐
120002H031000A	3/8"x10	10	200
120002H031200A	3/8"x12	10	150
120002H031400A	3/8"x14	10	150
120002H041000A	1/2"x10	10	150
120002H041200A	1/2"x12	10	150
120002H041400A	1/2"x14	10	120
120002H041600A	1/2"x16	10	120
120002H041800A	1/2"x18	10	120
120002H042200A	1/2"x22	10	80
120002H051200A	3/4"x12	10	100
120002H051400A	3/4"x14	10	100
120002H051600A	3/4"x16	10	100
120002H051800A	3/4"x18	10	80
120002H052200A	3/4"x22	10	70
120002H052800A	3/4"x28	10	50
120002H101800A	1"x18	10	50
120002H102200A	1"x22	10	50
120002H102800A	1"x28	5	50

1200.10

RACCORDO A T
TEE



CODICE	Ø	◇	☐
120010H101010A	10x10x10	10	70
120010H121212A	12x12x12	10	50
120010H141414A	14x14x14	10	50
120010H161616A	16x16x16	10	40
120010H181818A	18x18x18	10	30
120010H222222A	22x22x22	5	20
120010H282828A	28x28x28	5	10

1200.11

RACCORDO A T MASCHIO
MALE TEE



CODICE	Ø	◇	☐
120011H100410A	10x1/2"x10	10	70
120011H120412A	12x1/2"x12	10	60
120011H140414A	14x1/2"x14	10	40
120011H160416A	16x1/2"x16	10	40
120011H160516A	16x3/4"x16	10	30
120011H180418A	18x1/2"x18	10	40
120011H180518A	18x3/4"x18	10	30
120011H220522A	22x3/4"x22	5	20
120011H281028A	28x1"x28	5	10

1200.12RACCORDO A T FEMMINA
FEMALE TEE

CODICE	Ø	◇	☐
120012H100310A	10x3/8"x10	10	60
120012H100410A	10x1/2"x10	10	60
120012H120312A	12x3/8"x12	10	60
120012H120412A	12x1/2"x12	10	60
120012H140414A	14x1/2"x14	10	40
120012H160416A	16x1/2"x16	10	40
120012H160516A	16x3/4"x16	10	30
120012H180418A	18x1/2"x18	10	40
120012H180518A	18x3/4"x18	10	30
120012H220422A	22x1/2"x22	5	20
120012H220522A	22x3/4"x22	5	20
120012H280528A	28x3/4"x28	5	10

1200.20ANGOLO DOPPIO
DOUBLE ELBOW

CODICE	Ø	◇	☐
120020H101000A	10x10	10	120
120020H121200A	12x12	10	100
120020H141400A	14x14	10	100
120020H161600A	16x16	10	60
120020H181800A	18x18	10	40
120020H222200A	22x22	5	30
120020H282800A	28x28	5	20

1200.21

ANGOLO MASCHIO
MALE ELBOW



CODICE	Ø	◇	☐
120021H031000A	3/8"x10	10	150
120021H031200A	3/8"x12	10	120
120021H031400A	3/8"x14	10	80
120021H041000A	1/2"x10	10	100
120021H041200A	1/2"x12	10	100
120021H041400A	1/2"x14	10	80
120021H041600A	1/2"x16	10	80
120021H041800A	1/2"x18	10	60
120021H042200A	1/2"x22	10	50
120021H051400A	3/4"x14	10	70
120021H051600A	3/4"x16	10	70
120021H051800A	3/4"x18	10	60
120021H052200A	3/4"x22	5	40
120021H102200A	1"x22	5	30
120021H102800A	1"x28	5	20

1200.22

ANGOLO FEMMINA
FEMALE ELBOW



CODICE	Ø	◇	☐
120022H031000A	3/8"x10	10	120
120022H031200A	3/8"x12	10	120
120022H031400A	3/8"x14	10	80
120022H031600A	3/8"x16	10	80
120022H041000A	1/2"x10	10	80
120022H041200A	1/2"x12	10	80
120022H041400A	1/2"x14	10	80
120022H041600A	1/2"x16	10	70
120022H041800A	1/2"x18	10	40
120022H042200A	1/2"x22	10	30
120022H051400A	3/4"x14	10	50
120022H051600A	3/4"x16	10	50
120022H051800A	3/4"x18	10	50
120022H052200A	3/4"x22	5	40
120022H052800A	3/4"x28	5	20
120022H102200A	1"x22	5	20
120022H102800A	1"x28	5	20

1200.23

ATTACCO A MURO CON FLANGIA 3 FORI
WALLPLATE ELBOW WITH 3 HOLES



CODICE	Ø	◇	☐
120023H041000A	1/2"x10	10	60
120023H041200A	1/2"x12	10	60
120023H041400A	1/2"x14	10	50
120023H041600A	1/2"x16	10	50
120023H041800A	1/2"x18	10	50

1200.70

DADO
NUT



CODICE	Ø
120070H100000A	10
120070H120000A	12
120070H140000A	14
120070H160000A	16
120070H180000A	18
120070H220000A	22
120070H280000A	28

1200.81

ANELLO ELASTICO
BRASS RING



CODICE	Ø
120081H100000H	10
120081H120000H	12
120081H140000H	14
120081H160000H	16
120081H180000H	18
120081H220000H	22
120081H280000H	28

1200.82

RONDELLA PIANA
FLAT RING



CODICE	Ø
120082H100000H	10
120082H120000H	12
120082H140000H	14
120082H160000H	16
120082H180000H	18
120082H220000H	22
120082H280000H	28

OR00.10 O-RING
O-RING



CODICE	Ø
OR0010H092000H	9x2.0
OR0010H112600H	11.9x2.62
OR0010H132600H	13.6x2.7
OR0010H152700H	15.1x2.7
OR0010H162700H	16.9x2.7
OR0010H213500H	21.82x3.53
OR0010H263600H	26.2x3.6



SOBEK

SERIE 1400 LINE 1400



Raccordi cromati per idrosanitaria Sanitary chrome plated fittings

I raccordi cromati per idrosanitaria sono utilizzabili per adduzione acqua calda e fredda in impianti idrico-sanitari e in ogni tipo di installazione idraulica domestica, commerciale, industriale.

Chromed fittings for sanitary installations [LINE 1400] are suitable for cold and hot water supply for any kind of sanitary systems, such as domestic, commercial, industry installations.



VANTAGGI

- Ampiezza gamma
- Materie prime impiegate di alta qualità [UBA LIST]

ADVANTAGES

- *Wide range*
- *Raw materials complying with UBA LIST*

CAMPI DI APPLICAZIONI E PRESTAZIONI FIELDS OF APPLICATION





APPLICAZIONI APPLICATIONS		T. min.	T. max	Press.max Max. pressure
 acqua potabile drinking water		+5°C	+80°C	10 bar
 acqua calda sanitaria sanitary hot water		+5°C	+80°C	10 bar

FILETTATURA E SERRAGGIO DADI THREADS AND NUTS TIGHTENING

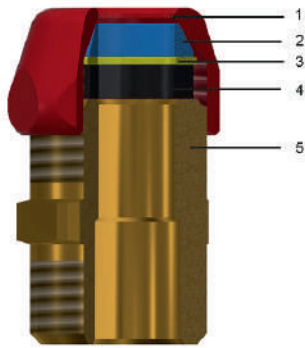
Ø	Attacco filetto Thread coupling	N° Giri (+1/4) N° Turns (+1/4)
Ø 8	3/8"	3/4
Ø 10	3/8"	3/4

COMPONENTI E MATERIALI RACCORDI COMPONENTS AND MATERIALS OF FITTINGS



LEGENDA LEGEND	COMPONENTI COMPONENTS	MATERIALI MATERIALS
	1 Dado Nut	Ottone CW617N - UNI EN 12164 Brass CW617N - UNI EN 12164
	2 Ogiva conica Cut olive	Ottone CW617N - UNI EN 12164 Brass CW617N - UNI EN 12164
	3 Anello Ring	Ottone CW617N - UNI EN 12164 Brass CW617N - UNI EN 12164
	4 Guarnizione Gasket	Elastomero per acqua potabile Elastomer for drinking water
	5 Corpo Body	Ottone CW617N cromato - UNI EN 12164/12165 Brass CW617N chrome plated - UNI EN 12164/12165



NORMATIVE

- I raccordi sono conformi alla norma UNI EN 1254-2: "Raccorderia idraulica per tubazioni rame con terminali a compressione."
- Tutte le filettature sono conformi alla norma UNI EN ISO 228-1:2003: "Filettatura di tubazioni per accoppiamento non a tenuta sul filetto".
- I materiali utilizzati sono conformi al Decreto Ministeriale n° 174 del 06/04/2004 [Regolamento concernente i materiali e gli oggetti che possono essere utilizzati negli impianti fissi di captazione, trattamento, adduzione e distribuzione delle acque destinate al consumo umano.
- Conforme a 4MS, UBA List (gruppo BC), DIN 50930/6 Dir. 2011/65/UE, 6C allegato III (RhOSII)

REGULATIONS

- *Fittings comply with UNI EN 1254-2 law: "Plumbing fittings - Fittings with compression ends for use with copper tubes."*
- *Threads complies with UNI EN ISO 228-1:2003 law: "Piping thread for coupling not with tightness on the thread".*
- *Raw materials used are of high quality and comply with the Ministerial Decree N°174 dated 06/04/2004.*
- *Comply with 4MS, UBA List (BC group), DIN 50930/6 Dir. 2011/65/UE, 6C attachment III (RhOSII)*

CERTIFICAZIONI CERTIFICATIONS

STATO COUNTRY	CERTIFICAZIONE CERTIFICATION	STATO COUNTRY	CERTIFICAZIONE CERTIFICATION	STATO COUNTRY	CERTIFICAZIONE CERTIFICATION
					
					
					

ISTRUZIONI DI MONTAGGIO ASSEMBLY INSTRUCTIONS

Utilizzando un apposito utensile taglia tubi [codice TT50.00] eseguire un taglio perpendicolare all'asse del tubo. Eliminare l'eventuale bava residua.

Cut the pipe perpendicularly to its axis using an appropriate pipe-cutting tool [code TT500.00]. Remove possible residual burr.

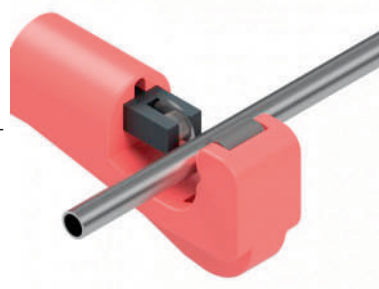

Inserire dado, ogiva tagliata, anello e guarnizione sul tubo.

Insert nut, cut olive, ring and gasket on the pipe.



Inserire il tubo nel corpo fino a battuta e avvitare il dado a mano, per quanto consentito.

Insert the pipe in the body until it stops and tighten the nut by hand until allowed.



Con chiave esagonale avvitare il dado fino a raggiungere il numero massimo di giri (come indicato nella precedente tabella).

With an hexagonal wrench, tighten the nut until reaching the number of threads shown in the table (previous page)



1400.00 RACCORDO DIRITTO DOPPIO CROMATO
DOUBLE CHROME-PLATED STRAIGHT FITTING



CODICE	Ø	◇	📦
140000C030800H	3/8"x8	10	200
140000C031000H	3/8"x10	10	200

1400.01 RACCORDO DIRITTO MASCHIO CROMATO
CHROME-PLATED MALE STRAIGHT FITTING



CODICE	Ø	◇	📦
140001C030310H	3/8"x3/8"x10	10	200
140001C040310H	1/2"x3/8"x10	5	180

1400.02 RACCORDO DIRITTO FEMMINA CROMATO
CHROME-PLATED FEMALE STRAIGHT FITTING



CODICE	Ø	◇	📦
140002C030310H	3/8"x3/8"x10	10	200
140002C040310H	1/2"x3/8"x10	10	150

1400.10 RACCORDO A T CROMATO
CHROME-PLATED TEE



CODICE	Ø	◇	📦
140010B031000A	3/8"x10	10	80

1400.20 ANGOLO DOPPIO CROMATO
CHROME-PLATED DOUBLE ELBOW



CODICE	Ø	◇	📦
140020B031000A	3/8"x10	10	100

1400.21 ANGOLO MASCHIO CROMATO
CHROME-PLATED MALE ELBOW



CODICE	Ø	◇	📦
140021B031000A	3/8"x10	10	120

1400.23 ATTACCO A MURO CROMATO CON FLANGIA 3 FORI
CHROME-PLATED WALLPLATE ELBOW WITH 3 HOLES



CODICE	Ø	◇	☐
140023B041000A	1/2"x3/8"x10	10	50

1400.G6 RACCORDO A Y SPAZZOLATO CROMATO
POLISHED CHROME-PLATED Y FITTING



CODICE	Ø	◇	☐
1400G6B040404H	1/2"	10	70

1400.G4 DADO CROMATO COMPLETO
COMPLETE CHROME-PLATED NUT



CODICE	Ø	◇	☐
1400G4C031000H	3/8"x10	10	500

1400.G7 RACCORDO A Y
Y FITTING



CODICE	Ø	◇	☐
1400G7H050505H	3/4"	10	50

1400.G5 RACCORDO UNIVERSALE CROMATO
UNIVERSAL CHROME-PLATED FITTINGS



CODICE	○	○	◇	☐
1400G5C050400H	1/2"	3/4"	10	200

1400.G7.C RACCORDO A Y CROMATO
CHROME-PLATED Y FITTING



CODICE	Ø	◇	☐
1400G7C050505H	3/4"	10	50

1400.70 DADO CROMATO
CHROME-PLATED NUT

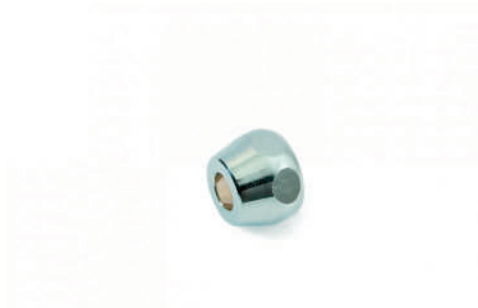

CODICE	Ø	◇	☐
140070C031000H	3/8"x10	10	500

1400.85 ADATTATORE CROMATO
CHROME-PLATED REDUCING ADAPTER



CODICE	○	○	◇	☐
140085C040500H	3/4"	1/2"	10	200
140085C042210H	M22X1	1/2"	10	200
140085C042215H	M22X1,5	1/2"	10	200
140085C052210H	M22X1	3/4"	10	200
140085C221004H	1/2"	M22X1	10	200
140085C221005H	3/4"	M22X1	10	200

 **GENERAL
FITTINGS**
YOUNIQUE · ITALIAN

RACCORDI PER TUBO
RAME

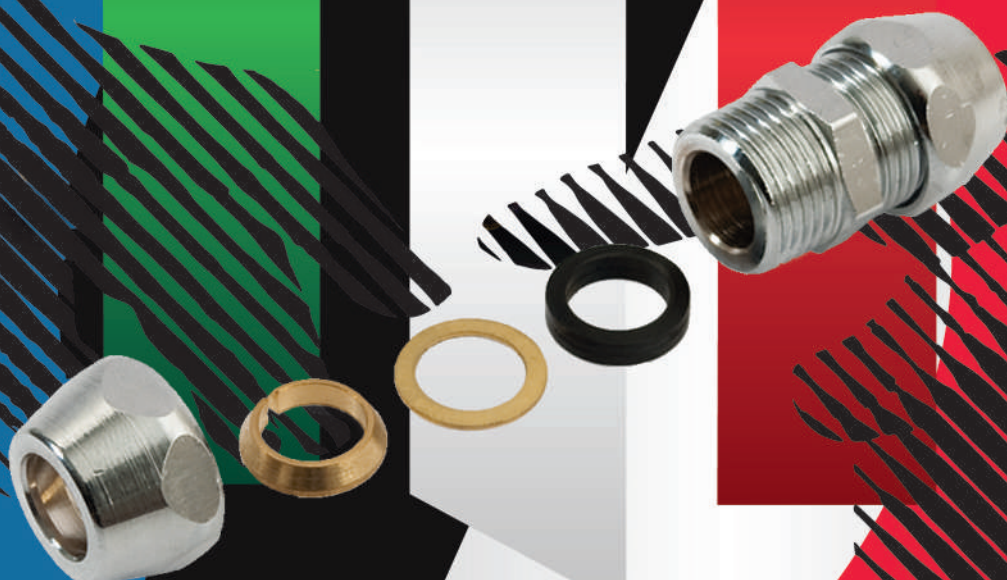

S**BEK**

SERIE/LINE 1400
RACCORDI CROMATI PER IDROSANITARIA
SANITARY CHROME PLATED FITTINGS

RACCORDI PER
TUBO FERRO
*FITTINGS FOR
IRON PIPE*





SERIE 2600 / 2700

LINE 2600 / 2700



Raccordi filettati in ottone

Brass threaded fittings

I raccordi filettati della SERIE 2600 e della SERIE 2700 sono realizzati interamente in ottone CW617N di elevata qualità. La filettatura è conforme alla norma UNI EN ISO 228-1:2003.

Sono utilizzabili in impianti idrico-sanitari per adduzione di acqua calda e fredda, in impianti di riscaldamento ed in ogni tipo di installazione idraulica, domestica, commerciale, industriale, agricola e generalmente con qualsiasi tipologia di fluido non corrosivo.

Grazie al vasto assortimento di figure e diametri e alle numerose varianti cromate e nichelate, i nostri raccordi filettati offrono agli installatori la possibilità di scegliere in qualsiasi momento il raccordo giusto per l'ambito di applicazione richiesto.

Fittings of LINE 2600/2700 are made of high-quality brass . Thread complies with UNI EN ISO 228-1:2003.

They are suitable for hot and cold water in sanitary and heating installations and in any kind of sanitary installation such as domestic, commercial, industry and farming. Nickel plated fittings can't be used for sanitary installations.

The wide assortment of shapes and diameters and the numerous chromed and nickel-plated variants meet all types of installations need.





VANTAGGI

- Completezza della gamma
- Disponibili in ottone giallo, ottone cromato, ottone cromato lucido, ottone nichelato
- Installazione rapida e sicura
- Dotati di sede per chiave e zigrinatura per un montaggio semplice e agevole
- Utilizzabili per acqua e per aria compressa
- Materie prime impiegate di alta qualità [UBA LIST]
- Lega di ottone CW617N conforme alle norme EN 12165
- Ottima resistenza alle alte temperature e agli agenti atmosferici

ADVANTAGES

- Complete range
- Available yellow, nickel-plated, chrome-plated and chrome polished brass version
- Quick and safe installation
- Equipped with key seat and knurling for simple and easy assembly
- Suitable for water and compressed air
- Raw materials complying with UBA LIST
- CW617N brass complying with EN 12165 standard
- Excellent resistance to high temperatures and atmospheric agents

CAMPI DI APPLICAZIONI E PRESTAZIONI FIELDS OF APPLICATION

APPLICAZIONI APPLICATIONS		T. min.	T. max con guarnizione T. max with gasket	T. max senza guarnizione T. max without gasket	Press.max con guarnizione Press.max with gasket	Press.max senza guarnizione Press.max without gasket
	acqua potabile drinking water	-20°C	+100°C	+120°C	10 bar	16 bar
	acqua calda sanitaria sanitary hot water	-20°C	+100°C	+120°C	10 bar	16 bar
	raffrescamento cooling	-20°C	+100°C	+120°C	10 bar	16 bar
	radiatori radiators	-20°C	+100°C	+120°C	10 bar	16 bar
	irrigazione irrigation	-20°C	+100°C	+120°C	10 bar	16 bar
	aria compressa compressed air	-20°C	+100°C	+120°C	10 bar	16 bar
	-20°C: solo con liquido antigelo, glicole, in % max del 30% -20°C: only with antifreeze liquid (glycol) in % max of 30%					

COMPONENTI E MATERIALI

Il corpo del raccordo è in ottone CW617N - UNI EN 12165, giallo, nichelato o cromato.

COMPONENTS AND MATERIALS

The body is made of brass CW617N - UNI 12165 (yellow, nickel plated, chrome plated).

NORMATIVE

- UNI EN 1254-4
I raccordi sono conformi alla norma UNI EN 1254-4: "Raccordi combinanti altri terminali di connessione con terminali di tipo capillare o a compressione."
- UNI EN ISO 228-1:2003
Tutte le filettature sono conformi alla norma UNI EN ISO 228-1:2003: "Filettatura di tubazioni per accoppiamento non a tenuta sul filetto".
- D.M. 174 (06/04/2004)
I materiali utilizzati sono conformi al Decreto Ministeriale n° 174 del 06/04/2004 [Regolamento concernente i materiali e gli oggetti che possono essere utilizzati negli impianti fissi di captazione, trattamento, adduzione e distribuzione delle acque destinate al consumo umano].
- Conforme a 4MS, UBA List (gruppo BC), DIN 50930/6 Dir. 2011/65/UE, 6C allegato III (RhOSII)
- UNI EN 10255:2007
Tubi di acciaio non legato adatti alla saldatura e alla filettatura - Condizioni tecniche di fornitura.

REGULATIONS

- UNI EN 1254-4
Fittings comply with UNI EN 1254-4 law: "Fittings combined with other coupling capillary or compression ends"
- UNI EN ISO 228-1:2003
Threads complies with UNI EN ISO 228-1:2003 law: "Piping thread for coupling not with tightness on the thread".
- D.M. 174 (06/04/2004)
Raw materials used are of high quality and comply with the Ministerial Decree N°174 dated 06/04/2004 concerning the materials and the items used in fixed installations for water collection, treatment and supply.
- Comply with 4MS, UBA List (BC group), DIN 50930/6 Dir. 2011/65/UE, 6C attachment III (RhOSII).
- UNI EN 10255:2007
Non-Alloy steel tubes suitable for welding and threading - Technical delivery conditions.

CERTIFICAZIONI CERTIFICATIONS

STATO COUNTRY	CERTIFICAZIONE CERTIFICATION	STATO COUNTRY	CERTIFICAZIONE CERTIFICATION	STATO COUNTRY	CERTIFICAZIONE CERTIFICATION
					
					
					

ISTRUZIONI DI MONTAGGIO ASSEMBLY INSTRUCTIONS

Posizionare sul raccordo uno strato di materiale isolante (no canapa) per consentire una miglior tenuta sull'attacco.

Place over the fitting a lay of insulating material (no hemp) in order to obtain a better tightness on the coupling.

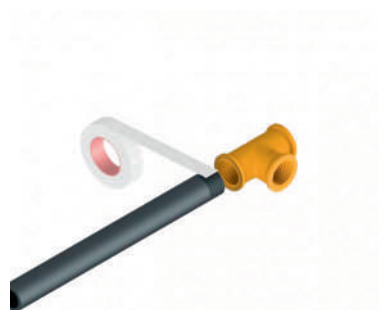

Verificare che non vi sia eccedenza di materiale aggiunto per prevenire possibili rotture per l'eccessivo serraggio.

Please check if there isn't an excess of the above mentioned coat, in order to prevent possible breakings caused by excessive screwing.



Collegare il raccordo con il circuito facendo attenzione a non eccedere con il serraggio del pezzo.

Verificare la filettatura del raccordo e inserire il tubo per la lunghezza massima pari alla filettatura, senza provocare deformazione del raccordo.

Connect the fitting with the circuit. Pay attention to not exceeding in tightening.

Please check fitting thread length and screw the pipe not more than this length. Be sure to avoid fitting deformation.



2600.00RACCORDO DIRITTO DOPPIO
DOUBLE STRAIGHT FITTING

CODICE	Ø	◇	☐
260000H010100H	1/8"	10	700
260000H020200H	1/4"	10	500
260000H030300H	3/8"	10	350
260000H040400H	1/2"	10	200
260000H050500H	3/4"	10	120
260000H101000H	1"	10	70
260000H121200H	1"1/4	-	50
260000H141400H	1"1/2	-	30
260000H202000H	2"	-	20
260000H242400H	2"1/2	-	10
260000H303000H	3"	-	10
260000H404000H	4"	-	5

2600.00.CRACCORDO DIRITTO DOPPIO CROMATO
DOUBLE CHROME-PLATED STRAIGHT FITTING

CODICE	Ø	◇	☐
260000C010100H	1/8"	10	700
260000C020200H	1/4"	10	500
260000C030300H	3/8"	10	350
260000C040400H	1/2"	10	200
260000C050500H	3/4"	10	120
260000C101000H	1"	10	70
260000C121200H	1"1/4	-	50
260000C141400H	1"1/2	-	30
260000C202000H	2"	-	20

2600.00.N RACCORDO DIRITTO DOPPIO NICHELATO
NICKEL-PLATED DOUBLE STRAIGHT FITTING



CODICE	Ø	◇	☐
260000N010100H	1/8"	10	700
260000N020200H	1/4"	10	500
260000N030300H	3/8"	10	350
260000N040400H	1/2"	10	200
260000N050500H	3/4"	10	120
260000N101000H	1"	10	70
260000N121200H	1 1/4"	-	50
260000N141400H	1 1/2"	-	30
260000N202000H	2"	-	20
260000N242400H	2 1/2"	-	10
260000N303000H	3"	-	10
260000N404000H	4"	-	5

2600.F3 RACCORDO DIRITTO DOPPIO PROLUNGATO
LONG DOUBLE STRAIGHT FITTING



CODICE	Ø	◇	☐
2600F3H040400H	1/2"	10	150
2600F3H050500H	3/4"	10	120
2600F3H101000H	1"	10	60

2600.F3.C RACCORDO DIRITTO DOPPIO PROLUNGATO
CROMATO
CHROME-PLATED LONG DOUBLE STRAIGHT FITTING



CODICE	Ø	◇	☐
2600F3C040400H	1/2"	10	150
2600F3C050500H	3/4"	5	100
2600F3C101000H	1"	10	60

2600.F3.N RACCORDO DIRITTO DOPPIO PROLUNGATO
NICHELATO
NICKEL-PLATED LONG STRAIGHT FITTING



CODICE	Ø	◇	☐
2600F3N040400H	1/2"	10	150
2600F3N050500H	3/4"	10	120
2600F3N101000H	1"	10	60

2600.01

RACCORDO DIRITTO PER MONOFORO
STRAIGHT FITTING, NUT AND WASHER



CODICE	Ø	◇	☐
260001H040300H	1/2"x3/8"x10	10	150

2600.01.C

RACCORDO DIRITTO CROMATO PER MONOFORO
CHROME-PLATED STRAIGHT FITTING, NUT AND
WASHER



CODICE	Ø	◇	☐
260001C040300H	1/2"x3/8"x10	10	150

2600.03

RACCORDO DIRITTO RIDOTTO
REDUCED STRAIGHT FITTING



CODICE	Ø	◇	☐
260003H020100H	1/4"x1/8"	10	500
260003H030200H	3/8"x1/4"	10	400
260003H040200H	1/2"x1/4"	10	250
260003H040300H	1/2"x3/8"	10	250
260003H050300H	3/4"x3/8"	10	150
260003H050400H	3/4"x1/2"	10	150
260003H100400H	1"x1/2"	10	90
260003H100500H	1"x3/4"	10	90
260003H120400H	1"1/4x1/2"	10	60
260003H120500H	1"1/4x3/4"	10	60
260003H121000H	1"1/4x1"	-	60
260003H140500H	1"1/2x3/4"	-	40
260003H141000H	1"1/2x1"	-	40
260003H141200H	1"1/2x1"1/4	-	40
260003H201000H	2"x1"	-	30
260003H201200H	2"x1"1/4	-	30
260003H201400H	2"x1"1/2	-	30
260003H242000H	2"1/2x2"	-	10
260003H302000H	3"x2"	-	15
260003H302400H	3"x2"1/2	-	10
260003H402400H	4"x2"1/2	-	7
260003H403000H	4"x3"	-	4

2600.03.C RACCORDO DIRITTO RIDOTTO CROMATO
 CHROME-PLATED REDUCED STRAIGHT FITTING

CODICE	Ø	◇	☐
260003C020100H	1/4"x1/8"	10	500
260003C030200H	3/8"x1/4"	10	400
260003C040200H	1/2"x1/4"	10	250
260003C040300H	1/2"x3/8"	10	250
260003C050300H	3/4"x3/8"	10	150
260003C050400H	3/4"x1/2"	10	150
260003C100400H	1"x1/2"	10	90
260003C100500H	1"x3/4"	10	90
260003C121000H	1"1/4x1"	-	60
260003C140500H	1"1/2x3/4"	-	40
260003C141000H	1"1/2x1"	-	40
260003C141200H	1"1/2x1"1/4	-	40
260003C201200H	2"x1"1/4	-	30
260003C201400H	2"x1"1/2	-	30

2600.03.N RACCORDO DIRITTO RIDOTTO NICHELATO
 NICKEL-PLATED REDUCED STRAIGHT FITTINGS

CODICE	Ø	◇	☐
260003N020100H	1/4"x1/8"	10	500
260003N030200H	3/8"x1/4"	10	400
260003N040200H	1/2"x1/4"	10	250
260003N040300H	1/2"x3/8"	10	250
260003N050300H	3/4"x3/8"	10	150
260003N050400H	3/4"x1/2"	10	150
260003N100400H	1"x1/2"	10	90
260003N100500H	1"x3/4"	10	90
260003N120400H	1"1/4x1/2"	10	60
260003N120500H	1"1/4x3/4"	10	60
260003N121000H	1"1/4x1"	-	60
260003N140500H	1"1/2x3/4"	-	40
260003N141000H	1"1/2x1"	-	40
260003N141200H	1"1/2x1"1/4	-	40
260003N201000H	2"x1"	-	30
260003N201200H	2"x1"1/4	-	30
260003N201400H	2"x1"1/2	-	30
260003N242000H	2"1/2x2"	-	10
260003N302000H	3"x2"	-	15
260003N302400H	3"x2"1/2	-	10
260003N402400H	4"x2"1/2	-	7
260003N403000H	4"x3"	-	4

2600.27CURVETTA CROMATA LUCIDA
POLISHED CHROME-PLATED ELBOW

CODICE	Ø	◇	☐
260027B040300A	1/2"x3/8"x10	2	40

2600.04RACCORDO DIRITTO PROLUNGATO
LONG STRAIGHT FITTING

CODICE	Ø	◇	☐
260004H030300H	3/8"x3/8"x10	-	200
260004H040300H	1/2"x3/8"x10	10	200

2600.04.CRACCORDO DIRITTO PROLUNGATO CROMATO
CHROME-PLATED LONG STRAIGHT FITTING

CODICE	Ø	◇	☐
260004C030300H	3/8"x3/8"x10	10	200
260004C040300H	1/2"x3/8"x10	10	200

2600.D6RACCORDO DIRITTO TUTTO FILETTO
RUNNING STRAIGHT FITTING

CODICE	Ø	◇	☐
2600D6H020000H	1/4"	10	800
2600D6H030000H	3/8"	10	400
2600D6H040000H	1/2"	10	250
2600D6H050000H	3/4"	10	120
2600D6H100000H	1"	10	80

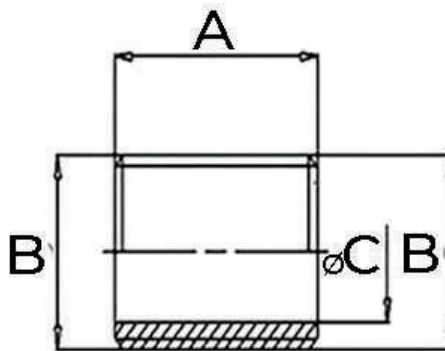

CODICE code	A	B	C
2600D6H020000H	18	1/4"	8
2600D6H030000H	22	3/8"	12
2600D6H040000H	30	1/2"	15
2600D6H050000H	30	3/4"	19
2600D6H100000H	35	1"	25

2600.38 PORTAGOMMA DOPPIO
HOSE ADAPTOR



CODICE	Ø	◇	☐
260038H040400H	1/2"	10	250
260038H050500H	3/4"	10	150
260038H101000H	1"	10	100

2600.40 TAPPO MASCHIO
MALE CAP



CODICE	Ø	◇	☐
260040H010000H	1/8"	10	700
260040H020000H	1/4"	10	600
260040H030000H	3/8"	10	400
260040H040000A	1/2"	10	300
260040H050000A	3/4"	10	200
260040H100000A	1"	10	100

2600.40.C TAPPO MASCHIO CROMATO
CHROME-PLATED MALE CAP



CODICE	Ø	◇	☐
260040C010000H	1/8"	10	700
260040C020000H	1/4"	10	600
260040C030000H	3/8"	10	400
260040C040000A	1/2"	10	300
260040C050000A	3/4"	10	200
260040C100000A	1"	10	100

2600.40.N TAPPO MASCHIO NICHELATO
NICKEL-PLATED MALE CAP



CODICE	Ø	◇	☐
260040N010000H	1/8"	10	700
260040N020000H	1/4"	10	600
260040N030000H	3/8"	10	400
260040N040000A	1/2"	10	300
260040N050000A	3/4"	10	200
260040N100000A	1"	10	100

2600.F4TAPPO MASCHIO CON QUADRO
MALE CAP WITH SQUARE

CODICE	Ø	◇	☐
2600F4H010000H	1/8"	10	500
2600F4H020000H	1/4"	10	500
2600F4H030000H	3/8"	10	350
2600F4H040000A	1/2"	10	250
2600F4H050000A	3/4"	10	200
2600F4H100000A	1"	10	100
2600F4H120000A	1"1/4	-	60
2600F4H140000A	1"1/2	-	40
2600F4H200000A	2"	-	40
2600F4H240000A	2"1/2	-	20
2600F4H300000A	3"	-	20

2600.F4.CTAPPO MASCHIO CROMATO CON QUADRO
CHROME-PLATED MALE CAP WITH SQUARE

CODICE	Ø	◇	☐
2600F4C030000H	3/8"	10	350
2600F4C040000A	1/2"	10	250
2600F4C050000A	3/4"	10	200
2600F4C100000A	1"	10	100
2600F4C120000A	1"1/4	-	60
2600F4C140000A	1"1/2	-	40
2600F4C200000A	2"	-	40
2600F4C240000A	2"1/2	-	20
2600F4C300000A	3"	-	20

2600.F4.N TAPPO MASCHIO NICHELATO CON QUADRO
NICKEL-PLATED MALE CAP WITH SQUARE



CODICE	Ø	◇	☐
2600F4N030000H	3/8"	10	350
2600F4N040000A	1/2"	10	250
2600F4N050000A	3/4"	10	200
2600F4N100000A	1"	10	100
2600F4N120000A	1"1/4	-	60
2600F4N140000A	1"1/2	-	40
2600F4N200000A	2"	-	40
2600F4N240000A	2"1/2	-	20
2600F4N300000A	3"	-	20

2600.41 TAPPO FEMMINA
FEMALE CAP

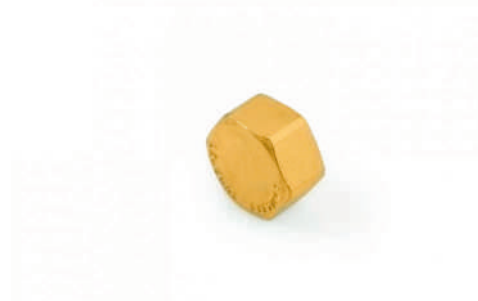

CODICE	Ø	◇	☐
260041H010000H	1/8"	10	700
260041H020000H	1/4"	10	500
260041H030000H	3/8"	10	400
260041H040000A	1/2"	10	350
260041H050000A	3/4"	10	200
260041H100000A	1"	10	100
260041H120000A	1"1/4	10	80
260041H140000A	1"1/2	-	70
260041H200000A	2"	-	30
260041H240000A	2"1/2	-	20

2600.41.N TAPPO FEMMINA NICHELATO
NICKEL-PLATED FEMALE CAP



CODICE	Ø	◇	📦
260041N010000H	1/8"	10	700
260041N020000H	1/4"	10	500
260041N030000H	3/8"	10	400
260041N040000A	1/2"	10	350
260041N050000A	3/4"	10	200
260041N100000A	1"	10	100
260041N120000A	1"1/4	10	80
260041N140000A	1"1/2	-	70
260041N200000A	2"	-	30

2600.41.C TAPPO FEMMINA CROMATO
CHROME-PLATED FEMALE CAP

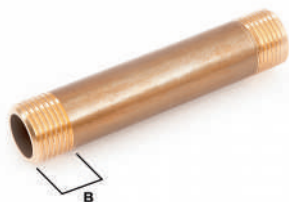

CODICE	Ø	◇	📦
260041C010000H	1/8"	10	700
260041C020000H	1/4"	10	500
260041C030000H	3/8"	10	400
260041C040000A	1/2"	10	350
260041C050000A	3/4"	10	200
260041C100000A	1"	10	100
260041C120000A	1"1/4	10	80
260041C140000A	1"1/2	-	70
260041C200000A	2"	-	30

2600.43PROLUNGA M/M
M/M EXTENSION

CODICE	i	Ø	◇	☐
260043H044000H	B=13	1/2"x40	10	150
260043H045000H	B=13	1/2"x50	10	120
260043H045500H	B=13	1/2"x55	10	100
260043H046000H	B=13	1/2"x60	10	100
260043H047000H	B=13	1/2"x70	10	100
260043H047500H	B=13	1/2"x75	5	100
260043H048000H	B=13	1/2"x80	10	80
260043H04B000H	B=13	1/2"x100	-	70
260043H04B200H	B=13	1/2"x120	-	70
260043H04B250H	B=13	1/2"x125	-	60
260043H04B500H	B=13	1/2"x150	-	50
260043H04B750H	B=13	1/2"x175	-	40
260043H04B900H	B=13	1/2"x190	-	30
260043H04C000H	B=13	1/2"x200	-	30
260043H04C250H	B=13	1/2"x225	-	30
260043H04C500H	B=13	1/2"x250	-	30
260043H04D000H	B=13	1/2"x300	-	15
260043H04E000H	B=13	1/2"x400	-	-
260043H04F000H	B=13	1/2"x500	-	-
260043H054000H	B=12,5	3/4"x40	10	100
260043H055000H	B=12,5	3/4"x50	10	50
260043H056000H	B=12,5	3/4"x60	5	50
260043H056500H	B=12,5	3/4"x65	5	50
260043H057000H	B=12,5	3/4"x70	5	50
260043H057500H	B=12,5	3/4"x75	5	50
260043H058000H	B=12,5	3/4"x80	5	40
260043H05B000H	B=12,5	3/4"x100	-	40
260043H05B200H	B=12,5	3/4"x120	-	30

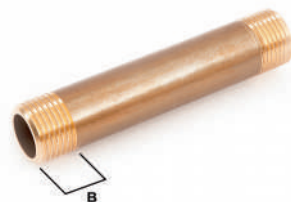
2600.43PROLUNGA M/M
M/M EXTENSION

CODICE	i	Ø	◇	☐
260043H05B250H	B=12,5	3/4"x125	-	30
260043H05B500H	B=12,5	3/4"x150	-	25
260043H05B750H	B=12,5	3/4"x175	-	25
260043H05C000H	B=12,5	3/4"x200	-	25
260043H05C250H	B=12,5	3/4"x225	-	20
260043H05C500H	B=12,5	3/4"x250	-	20
260043H05D000H	B=12,5	3/4"x300	-	10
260043H05D250H	B=12,5	3/4"x325	-	5
260043H05E000H	B=12,5	3/4"x400	-	-
260043H05E250H	B=12,5	3/4"x425	-	-
260043H05F000H	B=12,5	3/4"x500	-	-
260043H05F250H	B=12,5	3/4"x525	-	-
260043H105000H	B=12,5	1"x50	5	50
260043H106000H	B=12,5	1"x60	5	40
260043H107000H	B=12,5	1"x70	5	40
260043H107500H	B=12,5	1"x75	5	40
260043H108000H	B=12,5	1"x80	-	40
260043H10B000H	B=12,5	1"x100	-	30
260043H10B200H	B=12,5	1"x120	-	30
260043H10B250H	B=12,5	1"x125	-	25
260043H10B500H	B=12,5	1"x150	-	20
260043H10B750H	B=12,5	1"x175	-	20
260043H10C000H	B=12,5	1"x200	-	15
260043H10C250H	B=12,5	1"x225	-	15
260043H10C500H	B=12,5	1"x250	-	15
260043H10D000H	B=12,5	1"x300	-	8
260043H10E000H	B=12,5	1"x400	-	-
260043H10F000H	B=12,5	1"x500	-	-

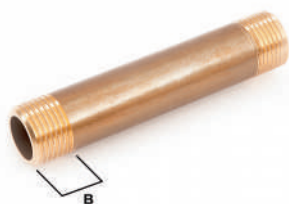
2600.43PROLUNGA M/M
M/M EXTENSION

CODICE	i	Ø	◇	☐
260043H125000H	B=16,5	1"1/4x50	5	30
260043H126000H	B=16,5	1"1/4x60	5	30
260043H127000H	B=16,5	1"1/4x70	-	30
260043H128000H	B=16,5	1"1/4x80	-	25
260043H129000H	B=16,5	1"1/4x90	-	20
260043H12B000H	B=16,5	1"1/4x100	-	15
260043H12B200H	B=16,5	1"1/4x120	-	15
260043H12B300H	B=16,5	1"1/4x130	-	15
260043H12B500H	B=16,5	1"1/4x150	-	15
260043H12B800H	B=16,5	1"1/4x180	-	10
260043H12C000H	B=16,5	1"1/4x200	-	10
260043H12C300H	B=16,5	1"1/4x230	-	8
260043H12C500H	B=16,5	1"1/4x250	-	8
260043H12D000H	B=16,5	1"1/4x300	-	3
260043H12D300H	B=16,5	1"1/4x330	-	-
260043H12E300H	B=16,5	1"1/4x430	-	-
260043H12F300H	B=16,5	1"1/4x530	-	-
260043H145000H	B=15	1"1/2x50	-	40
260043H146000H	B=15	1"1/2x60	-	30
260043H148000H	B=15	1"1/2x80	-	20
260043H149000H	B=15	1"1/2x90	-	15
260043H14B000H	B=15	1"1/2x100	-	15
260043H14B200H	B=15	1"1/2x120	-	15
260043H14B300H	B=15	1"1/2x130	-	15
260043H14B500H	B=15	1"1/2x150	-	10
260043H14B800H	B=15	1"1/2x180	-	10
260043H14C000H	B=15	1"1/2x200	-	8
260043H14C300H	B=15	1"1/2x230	-	8

2600.43PROLUNGA M/M
M/M EXTENSION

CODICE	i	Ø	◇	☐
260043H14D000H	B=15	1"1/2x300	-	3
260043H205000H	B=19,5	2"x50	-	20
260043H206000H	B=19,5	2"x60	-	15
260043H208000H	B=19,5	2"x80	-	15
260043H20B000H	B=19,5	2"x100	-	10
260043H20B200H	B=19,5	2"x120	-	10
260043H20B400H	B=19,5	2"x140	-	8
260043H20B500H	B=19,5	2"x150	-	8
260043H20B900H	B=19,5	2"x190	-	6
260043H20C000H	B=19,5	2"x200	-	6
260043H20C400H	B=19,5	2"x240	-	6
260043H20C500H	B=19,5	2"x250	-	5
260043H20D000H	B=19,5	2"x300	-	2

NB: Misura comprensiva di filettatura

NB: Total length including thread

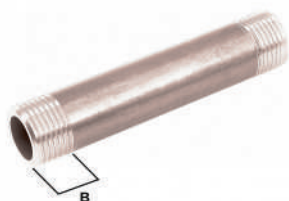
2600.43.C PROLUNGA M/M CROMATA
 CHROME-PLATED M/M EXTENSION

CODICE	i	Ø	◇	☐
260043C044000H	B=13	1/2"x40	10	150
260043C045000H	B=13	1/2"x50	10	120
260043C045500H	B=13	1/2"x55	10	100
260043C046000H	B=13	1/2"x60	10	100
260043C047000H	B=13	1/2"x70	10	100
260043C047500H	B=13	1/2"x75	5	100
260043C048000H	B=13	1/2"x80	10	80
260043C04B000H	B=13	1/2"x100	-	70
260043C04B250H	B=13	1/2"x125	-	60
260043C04B500H	B=13	1/2"x150	-	50
260043C04B750H	B=13	1/2"x175	-	40
260043C04B900H	B=13	1/2"x190	-	40
260043C04C000H	B=13	1/2"x200	-	30
260043C04C250H	B=13	1/2"x225	-	30
260043C04C500H	B=13	1/2"x250	-	30
260043C04D000H	B=13	1/2"x300	-	15
260043C04E000H	B=13	1/2"x400	-	30
260043C04F000H	B=13	1/2"x500	-	-
260043C054000H	B=12,5	3/4"x40	10	100
260043C055000H	B=12,5	3/4"x50	10	50
260043C056000H	B=12,5	3/4"x60	5	50
260043C056500H	B=12,5	3/4"x65	5	50
260043C057000H	B=12,5	3/4"x70	5	50
260043C057500H	B=12,5	3/4"x75	5	50
260043C058000H	B=12,5	3/4"x80	-	40
260043C05B000H	B=12,5	3/4"x100	-	40
260043C05B250H	B=12,5	3/4"x125	-	30
260043C05B500H	B=12,5	3/4"x150	-	25

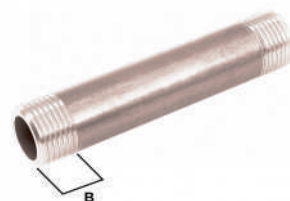
2600.43.C PROLUNGA M/M CROMATA
 CHROME-PLATED M/M EXTENSION

CODICE	i	Ø	◇	☐
260043C05B750H	B=12,5	3/4"x175	-	25
260043C05C000H	B=12,5	3/4"x200	-	25
260043C05C250H	B=12,5	3/4"x225	-	20
260043C05D000H	B=12,5	3/4"x300	-	10
260043C05D250H	B=12,5	3/4"x325	-	5
260043C05E000H	B=12,5	3/4"x400	-	-
260043C05E250H	B=12,5	3/4"x425	-	-
260043C05F000H	B=12,5	3/4"x500	-	-
260043C05F250H	B=12,5	3/4"x525	-	-
260043C104000H	B=12,5	1"x40	5	50
260043C105000H	B=12,5	1"x50	5	50
260043C106000H	B=12,5	1"x60	5	40
260043C107000H	B=12,5	1"x70	-	40
260043C107500H	B=12,5	1"x75	5	40
260043C108000H	B=12,5	1"x80	-	40
260043C10B000H	B=12,5	1"x100	-	30
260043C10B200H	B=12,5	1"x120	-	30
260043C10B250H	B=12,5	1"x125	-	25
260043C10B500H	B=12,5	1"x150	-	20
260043C10B750H	B=12,5	1"x175	-	30
260043C10C000H	B=12,5	1"x200	-	15
260043C10C250H	B=12,5	1"x225	-	15
260043C10D000H	B=12,5	1"x300	-	8
260043C10E000H	B=12,5	1"x400	-	-
260043C10F000H	B=12,5	1"x500	-	-
260043C10F250H	B=12,5	1"x525	-	-
260043C125000H	B=16,5	1"1/4"x50	5	30
260043C126000H	B=16,5	1"1/4"x60	5	30

2600.43.C PROLUNGA M/M CROMATA
CHROME-PLATED M/M EXTENSION

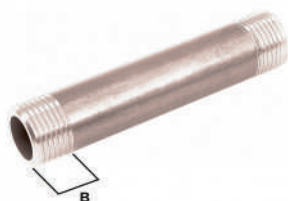

CODICE	i	Ø	◇	☐
260043C127000H	B=16,5	1"1/4x70	-	30
260043C128000H	B=16,5	1"1/4x80	-	25
260043C129000H	B=16,5	1"1/4x90	-	20
260043C12B000H	B=16,5	1"1/4x100	-	15
260043C12B200H	B=16,5	1"1/4x120	-	15
260043C12B300H	B=16,5	1"1/4x130	-	15
260043C12B500H	B=16,5	1"1/4x150	-	15
260043C12B800H	B=16,5	1"1/4x180	-	10
260043C12C000H	B=16,5	1"1/4x200	-	10
260043C12C300H	B=16,5	1"1/4x230	-	8
260043C12C500H	B=16,5	1"1/4x250	-	8
260043C12D000H	B=16,5	12"7/4x300	-	-
260043C12D300H	B=16,5	1"1/4x330	-	-
260043C12E300H	B=16,5	1"1/4x430	-	-
260043C12F300H	B=16,5	1"1/4x530	-	-
260043C145000H	B=15	1"1/2x50	-	40
260043C146000H	B=15	1"1/2x60	-	30
260043C147000H	B=15	1"1/2x70	-	-
260043C148000H	B=15	1"1/2x80	-	20
260043C149000H	B=15	1"1/2x90	-	15
260043C14B000H	B=15	1"1/2x100	-	15
260043C14B200H	B=15	1"1/2x120	-	15
260043C14B300H	B=15	1"1/2x130	-	15
260043C14B500H	B=15	1"1/2x150	-	10
260043C14B800H	B=15	1"1/2x180	-	-
260043C14C000H	B=15	1"1/2x200	-	8
260043C14C300H	B=15	1"1/2x230	-	8
260043C14D000H	B=15	1"1/2x300	-	3

2600.43.C PROLUNGA M/M CROMATA
CHROME-PLATED M/M EXTENSION

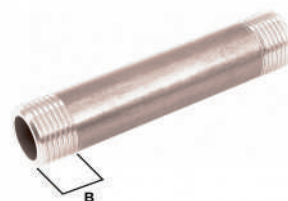

CODICE	i	Ø	◇	☐
260043C205000H	B=19,5	2"x50	-	20
260043C206000H	B=19,5	2"x60	-	15
260043C208000H	B=19,5	2"x80	-	15
260043C20B000H	B=19,5	2"x100	-	10
260043C20B200H	B=19,5	2"x120	-	10
260043C20B400H	B=19,5	2"x140	-	8
260043C20B500H	B=19,5	2"x150	-	8
260043C20B900H	B=19,5	2"x190	-	6
260043C20C000H	B=19,5	2"x200	-	6
260043C20C400H	B=19,5	2"x240	-	6
260043C20C500H	B=19,5	2"x250	-	5
260043C20D000H	B=19,5	2"x300	-	-

NB: Misura comprensiva di filettatura

NB: Total length including thread

2600.44 RIDUZIONE ESAGONALE M/F
M/F HEXAGONAL BUSHING

CODICE	Ø	◇	☐
260044H020100H	1/4"x1/8"	10	600
260044H030100H	3/8"x1/8"	10	400
260044H030200H	3/8"x1/4"	10	400
260044H040200H	1/2"x1/4"	10	300
260044H040300H	1/2"x3/8"	10	300
260044H050200H	3/4"x1/4"	10	200
260044H050300H	3/4"x3/8"	10	200
260044H050400H	3/4"x1/2"	10	200
260044H100200H	1"x1/4"	-	-
260044H100300H	1"x3/8"	10	100
260044H100400H	1"x1/2"	10	100
260044H100500H	1"x3/4"	10	100
260044H120400H	1"1/4x1/2"	10	70
260044H120500H	1"1/4x3/4"	10	70
260044H121000H	1"1/4x1"	10	70
260044H140400H	1"1/2x1/2"	-	50
260044H140500H	1"1/2x3/4"	-	50
260044H141000H	1"1/2x1"	-	50
260044H141200H	1"1/2x1"1/4"	-	50
260044H200400H	2"x1/2"	-	20
260044H200500H	2"x3/4"	-	20
260044H201000H	2"x1"	-	30
260044H201200H	2"x1"1/4"	-	30
260044H201400H	2"x1"1/2"	-	30
260044H242000H	2"1/2x2"	-	20
260044H301200H	3"x1"1/4"	-	18
260044H301400H	3"x1"1/2"	-	18
260044H302000H	3"x2"	-	18

2600.44 RIDUZIONE ESAGONALE M/F
M/F HEXAGONAL BUSHING

CODICE	Ø	◇	☐
260044H302400H	3"x2"1/2"	-	15
260044H402000H	4"x2"	-	5
260044H402400H	4"x2"1/2"	-	5
260044H403000H	4"x3"	-	6

2600.44.C RIDUZIONE ESAGONALE M/F CROMATA
CHROME-PLATED M/F HEXAGONAL BUSHING



CODICE	Ø	◇	☐
260044C020100H	1/4"x1/8"	10	600
260044C030100H	3/8"x1/8"	10	400
260044C030200H	3/8"x1/4"	10	400
260044C040200H	1/2"x1/4"	10	300
260044C040300H	1/2"x3/8"	10	300
260044C050200H	3/4"x1/4"	10	200
260044C050300H	3/4"x3/8"	10	200
260044C050400H	3/4"x1/2"	10	200
260044C100200H	1"x1/4"	-	-
260044C100300H	1"x3/8"	10	100
260044C100400H	1"x1/2"	10	100
260044C100500H	1"x3/4"	10	100
260044C120500H	1"1/4x3/4"	10	70
260044C121000H	1"1/4x1"	10	70
260044C140500H	1"1/2x3/4"	-	50
260044C141000H	1"1/2x1"	-	50
260044C141200H	1"1/2x1"1/4	-	50
260044C200500H	2"x3/4"	-	20
260044C301200H	3"x1"1/4	-	18
260044C301400H	3"x1"1/2	-	18
260044C302400H	3"x2"1/2	-	15
260044C403000H	4"x3"	-	6

2600.44.N RIDUZIONE ESAGONALE M/F NICHELATA
NICKEL-PLATED M/F HEXAGONAL BUSHING



CODICE	Ø	◇	☐
260044N020100H	1/4"x1/8"	10	600
260044N030100H	3/8"x1/8"	10	400
260044N030200H	3/8"x1/4"	10	400
260044N040200H	1/2"x1/4"	5	300
260044N040300H	1/2"x3/8"	10	300
260044N050200H	3/4"x1/4"	10	200
260044N050300H	3/4"x3/8"	10	200
260044N050400H	3/4"x1/2"	10	200
260044N100200H	1"x1/4"	-	-
260044N100300H	1"x3/8"	10	100
260044N100400H	1"x1/2"	10	100
260044N100500H	1"x3/4"	10	100
260044N120400H	1"1/4x1/2"	10	70
260044N120500H	1"1/4x3/4"	10	70
260044N121000H	1"1/4x1"	10	70
260044N140400H	1"1/2x1/2"	-	50
260044N140500H	1"1/2x3/4"	-	50
260044N141000H	1"1/2x1"	-	50
260044N141200H	1"1/2x1"1/4	-	50
260044N200400H	2"x1/2"	-	20
260044N200500H	2"x3/4"	-	20
260044N201000H	2"x1"	-	30
260044N201200H	2"x1"1/4	-	30
260044N201400H	2"x1"1/2	-	30
260044N242000H	2"1/2x2"	-	20
260044N302000H	3"x2"	-	18
260044N302400H	3"x2"1/2	-	15
260044N403000H	4"x3"	-	6

2600.45RIDUZIONE F/M
F/M REDUCED EXTENSION

CODICE	Ø	◇	☐
260045R020100A	1/4"x1/8"	10	400
260045R030200A	3/8"x1/4"	10	400
260045R040200A	1/2"x1/4"	10	250
260045R040300A	1/2"x3/8"	10	250
260045R050300A	3/4"x3/8"	10	150
260045R050400A	3/4"x1/2"	10	150
260045R100400A	1"x1/2"	10	100
260045R100500A	1"x3/4"	10	100
260045H120400A	1"1/4x1/2"	10	70
260045H120500A	1"1/4x3/4"	10	70
260045H121000A	1"1/4x1"	10	60
260045H140400H	1"1/2x1/2"	-	40
260045H140500H	1"1/2x3/4"	-	40
260045H141000H	1"1/2x1"	-	40
260045H141200H	1"1/2x1"1/4	-	40
260045H201000H	2"x1"	-	25
260045H201200H	2"x1"1/4	-	25
260045H201400H	2"x1"1/2	-	25

2600.F2RIDUZIONE F/M - SERIE PESANTE
F/M REDUCED EXTENSION - HEAVY TYPE

CODICE	Ø	◇	☐
2600F2R040300A	1/2"x3/8"	10	200
2600F2R050400A	3/4"x1/2"	10	150

2600.45.C RIDUZIONE F/M CROMATA
CHROME-PLATED F/M REDUCED EXTENSION



CODICE	Ø	◇	☐
260045C020100A	1/4"x1/8"	10	400
260045C030200A	3/8"x1/4"	10	400
260045C040200A	1/2"x1/4"	10	250
260045C040300A	1/2"x3/8"	10	250
260045C050300A	3/4"x3/8"	10	150
260045C050400A	3/4"x1/2"	10	150
260045C100400A	1"x1/2"	10	100
260045C100500A	1"x3/4"	10	100
260045C120400A	1"1/4x1/2"	10	70
260045C120500A	1"1/4x3/4"	10	70
260045C121000A	1"1/4x1"	10	60
260045C140400H	1"1/2x1/2"	-	40
260045C140500H	1"1/2x3/4"	-	40
260045C141000H	1"1/2x1"	-	40
260045C141200H	1"1/2x1"1/4"	-	40
260045C201000H	2"x1"	-	25
260045C201200H	2"x1"1/4"	-	25
260045C201400H	2"x1"1/2"	-	25

2600.F2.C RIDUZIONE F/M CROMATA - SERIE PESANTE
CHROME-PLATED F/M REDUCED EXTENSION -HEAVY
TYPE



CODICE	Ø	◇	☐
2600F2C040300A	1/2"x3/8"	10	200
2600F2C050400A	3/4"x1/2"	10	100

2600.45.N RIDUZIONE F/M NICHELATA
NICKEL-PLATED F/M REDUCED EXTENSION



CODICE	Ø	◇	☐
260045N020100A	1/4"x1/8"	10	400
260045N030200A	3/8"x1/4"	10	400
260045N040200A	1/2"x1/4"	10	250
260045N040300A	1/2"x3/8"	10	250
260045N050300A	3/4"x3/8"	10	150
260045N050400A	3/4"x1/2"	5	120
260045N100400A	1"x1/2"	10	100
260045N100500A	1"x3/4"	10	100
260045N120400A	1"x1/4x1/2"	10	70
260045N120500A	1"x1/4x3/4"	10	70
260045N121000A	1"x1/4x1"	10	60
260045N140400H	1"x1/2x1/2"	-	40
260045N140500H	1"x1/2x3/4"	-	40
260045N141000H	1"x1/2x1"	-	40
260045N141200H	1"x1/2x1"1/4	-	40
260045N201000H	2"x1"	-	25
260045N201200H	2"x1"1/4	-	25
260045N201400H	2"x1"1/2	-	25

2600.F2.N RIDUZIONE F/M NICHELATA - SERIE PESANTE
NICKEL-PLATED F/M REDUCED EXTENSION -HEAVY
TYPE



CODICE	Ø	◇	☐
2600F2N040300A	1/2"x3/8"	10	200
2600F2N050400A	3/4"x1/2"	10	150

2600.46 MANICOTTO
SOCKET



CODICE	Ø	◇	☐
260046H010100A	1/8"	10	600
260046H020200A	1/4"	10	350
260046H030300A	3/8"	10	200
260046H040400A	1/2"	10	150
260046H050500A	3/4"	10	90
260046H101000A	1"	10	60
260046H121200A	1"1/4	-	30
260046H141400A	1"1/2	-	30
260046H202000A	2"	-	15
260046H242400A	2"1/2	-	6
260046H303000A	3"	-	5

2600.46.C MANICOTTO CROMATO
CHROME-PLATED SOCKET



CODICE	Ø	◇	☐
260046C010100A	1/8"	10	600
260046C020200A	1/4"	10	350
260046C030300A	3/8"	10	200
260046C040400A	1/2"	10	150
260046C050500A	3/4"	10	90
260046C101000A	1"	10	60
260046C121200A	1"1/4	-	30
260046C141400A	1"1/2	-	30
260046C202000A	2"	-	15

2600.46.N MANICOTTO NICHELATO
NICKEL-PLATED SOCKET



CODICE	Ø	◇	☐
260046N010100A	1/8"	10	600
260046N020200A	1/4"	10	350
260046N030300A	3/8"	10	200
260046N040400A	1/2"	10	150
260046N050500A	3/4"	10	90
260046N101000A	1"	10	60
260046N121200A	1"1/4	-	30
260046N141400A	1"1/2	-	30
260046N202000A	2"	-	15

2600.46.B MANICOTTO CROMATO LUCIDO
POLISHED CHROME-PLATED SOCKET



CODICE	Ø	◇	☐
260046B040400A	1/2"	10	150
260046B050500A	3/4"	10	90
260046B101000A	1"	10	60
260046B121200A	1"1/4	-	30

2600.47MANICOTTO RIDOTTO
REDUCED SOCKET

CODICE	Ø	◇	☐
260047H020100A	1/4"x1/8"	10	300
260047H030200A	3/8"x1/4"	10	250
260047H040200A	1/2"x1/4"	10	200
260047H040300A	1/2"x3/8"	10	200
260047H050400A	3/4"x1/2"	10	100
260047H100300A	1"x3/8"	10	70
260047H100400A	1"x1/2"	10	70
260047H100500A	1"x3/4"	10	50
260047H120400A	1"1/4x1/2"	5	30
260047H120500A	1"1/4x3/4"	5	30
260047H121000A	1"1/4x1"	5	30
260047H140400A	1"1/2x1/2"	-	30
260047H140500A	1"1/2x3/4"	-	30
260047H141000A	1"1/2x1"	-	25
260047H141200A	1"1/2x1"1/4	-	30
260047H200500A	2"x3/4"	-	20
260047H201000A	2"x1"	-	20
260047H201200A	2"x1"1/4	-	20
260047H201400A	2"x1"1/2	-	20

2600.47.CMANICOTTO RIDOTTO CROMATO
CHROME-PLATED REDUCED SOCKET

CODICE	Ø	◇	☐
260047C020100A	1/4"x1/8"	10	300
260047C030200A	3/8"x1/4"	10	250
260047C040300A	1/2"x3/8"	10	200
260047C050400A	3/4"x1/2"	10	100
260047C100300A	1"x3/8"	10	70
260047C100400A	1"x1/2"	10	70
260047C100500A	1"x3/4"	10	50
260047C120400A	1"1/4x1/2"	5	30
260047C120500A	1"1/4x3/4"	5	30
260047C121000A	1"1/4x1"	5	30
260047C140400A	1"1/2x1/2"	5	30
260047C140500A	1"1/2x3/4"	5	30
260047C141000A	1"1/2x1"	-	25
260047C141200A	1"1/2x1"1/4	-	30
260047C201200A	2"x1"1/4	-	20
260047C201400A	2"x1"1/2	-	20

2600.47.B MANICOTTO RIDOTTO CROMATO LUCIDO
POLISHED CHROME-PLATED REDUCED SOCKET



CODICE	Ø	◇	☐
260047B050400A	3/4"x1/2"	10	100
260047B100400A	1"x1/2"	10	70
260047B100500A	1"x3/4"	10	50
260047B141200A	1"1/2x1"1/4	-	30

2600.47.N MANICOTTO RIDOTTO NICHELATO
NICKEL-PLATED REDUCED SOCKET



CODICE	Ø	◇	☐
260047N020100A	1/4"x1/8"	10	300
260047N030200A	3/8"x1/4"	10	250
260047N040300A	1/2"x3/8"	10	200
260047N050400A	3/4"x1/2"	10	100
260047N100300A	1"x3/8"	10	70
260047N100400A	1"x1/2"	10	70
260047N100500A	1"x3/4"	10	50
260047N120400A	1"1/4x1/2"	5	30
260047N120500A	1"1/4x3/4"	5	30
260047N121000A	1"1/4x1"	5	30
260047N140400A	1"1/2x1/2"	-	30
260047N140500A	1"1/2x3/4"	-	30
260047N141000A	1"1/2x1"	-	25
260047N141200A	1"1/2x1"1/4	-	30
260047N200500A	2"x3/4"	-	20
260047N201000A	2"x1"	-	20
260047N201200A	2"x1"1/4	-	20
260047N201400A	2"x1"1/2	-	20

2600.70 **CONTRODADO**
BACKNUT

CODICE	Ø	◇	☐
260070H010000H	1/8"	10	1000
260070H020000H	1/4"	10	800
260070H030000H	3/8"	10	700
260070H040000H	1/2"	10	500
260070H050000H	3/4"	10	400
260070H100000H	1"	10	200
260070H120000H	1"1/4	10	150
260070H140000H	1"1/2	10	150

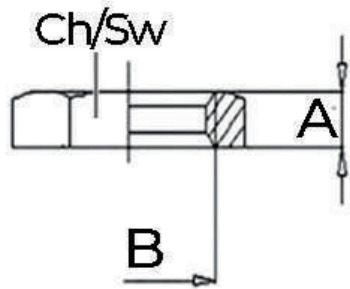

CODICE code	A	B	Ch/Sw
260070H010000H	4,5	1/8"	14
260070H020000H	5	1/4"	17
260070H030000H	5	3/8"	19
260070H040000H	5	1/2"	25
260070H050000H	6	3/4"	32
260070H100000H	8	1"	38
260070H120000H	8	1"1/4	48

2600.70.C **CONTRODADO CROMATO**
CHROME-PLATED BACKNUT

CODICE	Ø	◇	☐
260070C010000H	1/8"	10	1000
260070C020000H	1/4"	10	800
260070C030000H	3/8"	10	700
260070C040000H	1/2"	10	500
260070C050000H	3/4"	10	400
260070C100000H	1"	10	200
260070C120000H	1"1/4	10	150

2600.70.N **CONTRODADO NICHELATO**
NICKEL-PLATED BACKNUT

CODICE	Ø	◇	☐
260070N020000H	1/4"	10	800
260070N030000H	3/8"	10	700
260070N040000H	1/2"	10	500
260070N050000H	3/4"	10	400
260070N100000H	1"	10	200
260070N120000H	1"1/4	10	150

2600.74 RUBINETTO SFIATO CALORIFERO TENUTA O-RING
AIR OUTLET VALVE WITH O-RING



CODICE	Ø	◇	☐
260074H010000H	1/8"	10	500
260074H020000H	1/4"	10	400
260074H030000H	3/8"	10	300
260074H040000H	1/2"	10	300

2600.74.N RUBINETTO SFIATO CALORIFERO NICHELATO
TENUTA O-RING
NICKEL-PLATED AIR OUTLET VALVE WITH O-RING



CODICE	Ø	◇	☐
260074N010000H	1/8"	10	500
260074N020000H	1/4"	10	400
260074N030000H	3/8"	10	300
260074N040000H	1/2"	10	300

2600.96 SCORREVOLE MASCHIO
MALE RUNNING FITTING



CODICE	Ø	☐
260096H047500H	1/2"x75	100
260096H04B000H	1/2"x100	70
260096H04B500H	1/2"x150	50
260096H04C000H	1/2"x200	50
260096H05B000H	3/4"x100	50
260096H05B500H	3/4"x150	30
260096H05C000H	3/4"x200	20
260096H10B000H	1"x100	25
260096H10B500H	1"x150	25
260096H10C000H	1"x200	15

NB: Misura comprensiva di filettatura

NB: Total length including thread

2600.96.C SCORREVOLE MASCHIO CROMATO
CHROME-PLATED MALE RUNNING FITTING



CODICE	Ø	
260096C04B000H	1/2"x100	70
260096C04B500H	1/2"x150	50
260096C04C000H	1/2"x200	50
260096C05B000H	3/4"100	30
260096C05B500H	3/4"150	30
260096C05C000H	3/4"x200	20
260096C10B000H	1"x100	25
260096C10B500H	1"x150	25

NB: Misura comprensiva di filettatura

NB: Total length including thread

2600.96.N SCORREVOLE MASCHIO NICHELATO
NICKEL-PLATED RUNNING MALE FITTING



CODICE	Ø	
260096N047500H	1/2" x 75	100
260096N04B000H	1/2" x 100	70
260096N04B500H	1/2" x 150	50
260096N04C000H	1/2" x 200	50
260096N05B500H	3/4" x 150	30
260096N05C000H	3/4" x 200	20

NB: Misura comprensiva di filettatura

NB: Total length including thread

2600.D1GHIERA RIDUZIONE
REDUCING RING NUT

CODICE	Ø	◇	☐
2600D1H030200H	3/8"x1/4"	10	500
2600D1H040200H	1/2"x1/4"	10	500
2600D1H040300H	1/2"x3/8"	10	500
2600D1H050400H	3/4"x1/2"	10	350
2600D1H100400H	1"x1/2"	10	200
2600D1H100500H	1"x3/4"	10	200
2600D1H121000H	1"1/4x1"	10	150
2600D1H141200H	1"1/2x1"1/4	5	100
2600D1H200500H	2"x3/4"	5	50
2600D1H201000H	2"x1"	5	50
2600D1H201200H	2"x1"1/4	5	50
2600D1H201400H	2"x1"1/2	5	50

2600.D1.CGHIERA RIDUZIONE CROMATA
CHROME-PLATED REDUCING RING NUT

CODICE	Ø	◇	☐
2600D1C040200H	1/2"x1/4"	10	500
2600D1C040300H	1/2"x3/8"	10	500
2600D1C050400H	3/4"x1/2"	10	350
2600D1C100400H	1"x1/2"	10	200
2600D1C100500H	1"x3/4"	10	200
2600D1C200500H	2"x3/4"	5	50
2600D1C201200H	2"x1"1/4	5	50
2600D1C201400H	2"x1"1/2	5	50

2600.D1.NGHIERA RIDUZIONE NICHELATO
NICKEL-PLATED REDUCING RING NUT

CODICE	Ø	◇	☐
2600D1N040300H	1/2"x3/8"	10	500
2600D1N050400H	3/4"x1/2"	10	350
2600D1N100500H	1"x3/4"	10	200
2600D1N121000H	1"1/4x1"	10	150
2600D1N141200H	1"1/2x1"1/4	10	100
2600D1N200500H	2"x3/4"	5	50
2600D1N201000H	2"x1"	5	50
2600D1N201200H	2"x1"1/4	5	50
2600D1N201400H	2"x1"1/2	5	50

2600.D2 RIDUZIONE ESAGONALE F/M
F/M HEXAGONAL BUSHING



CODICE	Ø	◇	☐
2600D2H121000H	1"1/4x1"	10	80
2600D2H141200H	1"1/2x1"1/4	-	60

2600.D2.B RIDUZIONE ESAGONALE F/M CROMATA LUCIDA
POLISHED CHROME-PLATED F/M HEXAGONAL
BUSHING



CODICE	Ø	◇	☐
2600D2B121000H	1"1/4x1"	10	80
2600D2B141200H	1"1/2x1"1/4	-	60

2600.D3 CURVETTA SOTTOLAVABO CROMATA
CHROME-PLATED ELBOW FOR WASH BASIN



CODICE	Ø	◇	☐
2600D3C041000A	1/2"x10	2	40

2600.D4 TAPPO MASCHIO COMPLETO
CHROME-PLATED MALE COMPLETE CAP



CODICE	Ø	◇	☐
2600D4C030000H	3/8"	10	150
2600D4C040000H	1/2"	10	100

2600.D5 TAPPO DOPPIO CROMATO
CHROME-PLATED DOUBLE CAP



CODICE	Ø	◇	☐
2600D5C040000H	1/2"	10	250

2600.D7GHIERA FLANGIATA
FLANGED BACKNUT

CODICE	Ø	◇	☐
2600D7H040000H	1/2"	10	250
2600D7H050000H	3/4"	10	200
2600D7H100000H	1"	10	150
2600D7H120000H	1"1/4	10	100
2600D7H140000H	1"1/2	10	80
2600D7H200000H	2"	10	50

2600.D7.NGHIERA FLANGIATA NICHELATA
NICKEL-PLATED FLANGED BACKNUT

CODICE	Ø	◇	☐
2600D7N040000H	1/2"	10	250
2600D7N050000H	3/4"	10	200
2600D7N100000H	1"	10	150
2600D7N120000H	1"1/4	10	100
2600D7N140000H	1"1/2	10	80
2600D7N200000H	2"	10	50

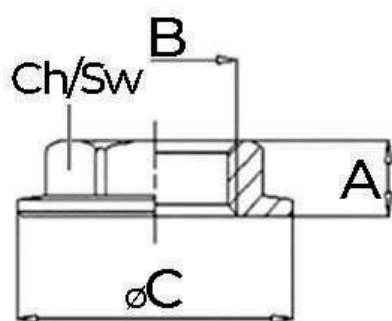

CODICE code	A	B	ØC	Ch/Sw
2600D7H040000H	8,4	1/2"	35	24,5
2600D7H050000H	8,4	3/4"	43	30,5
2600D7H100000H	8	1"	49	37,5
2600D7H120000H	8	1"1/4	58	47
2600D7H140000H	8	1"1/2	67,5	53
2600D7H200000H	9	2"	76,5	64

2600.F6

PROLUNGA LEGGERA
LIGHT EXTENSION



1/2"

3/4"

CODICE	Ø	◇	☐
2600F6H041000A	1/2" x 10	10	200
2600F6H041500A	1/2" x 15	10	200
2600F6H042000A	1/2" x 20	10	200
2600F6H042500A	1/2" x 25	10	150
2600F6H043000A	1/2" x 30	10	100
2600F6H044000A	1/2" x 40	10	100
2600F6H045000A	1/2" x 50	10	80
2600F6H046000A	1/2" x 60	10	80
2600F6H047000A	1/2" x 70	5	60
2600F6H048000A	1/2" x 80	-	50
2600F6H04B000A	1/2" x 100	-	40
2600F6R051000A	3/4" x 10	10	150
2600F6R051500A	3/4" x 15	10	100
2600F6R052000A	3/4" x 20	10	100
2600F6R052500A	3/4" x 25	10	80
2600F6R053000A	3/4" x 30	10	80
2600F6R054000A	3/4" x 40	10	80
2600F6R055000A	3/4" x 50	10	50
2600F6R056000A	3/4" x 60	10	50
2600F6R058000A	3/4" x 80	-	30
2600F6R05B000A	3/4" x 100	-	40

NB: Misura non comprensiva di filettatura

NB: Length not including thread

2600.F6.C

PROLUNGA LEGGERA CROMATA
CHROME-PLATED LIGHT EXTENSION



1/2"

3/4"

CODICE	Ø	◇	☐
2600F6C041000A	1/2" x 10	10	200
2600F6C041500A	1/2" x 15	10	200
2600F6C042000A	1/2" x 20	10	200
2600F6C042500A	1/2" x 25	10	150
2600F6C043000A	1/2" x 30	10	100
2600F6C044000A	1/2" x 40	10	100
2600F6C045000A	1/2" x 50	10	80
2600F6C046000A	1/2" x 60	10	80
2600F6C047000A	1/2" x 70	5	60
2600F6C048000A	1/2" x 80	-	50
2600F6C04B000A	1/2" x 100	-	40
2600F6C051000A	3/4" x 10	10	150
2600F6C051500A	3/4" x 15	10	100
2600F6C052000A	3/4" x 20	10	100
2600F6C052500A	3/4" x 25	10	80
2600F6C053000A	3/4" x 30	10	80
2600F6C054000A	3/4" x 40	10	80
2600F6C055000A	3/4" x 50	10	50
2600F6C056000A	3/4" x 60	10	50
2600F6C058000A	3/4" x 80	-	30
2600F6C05B000A	3/4" x 100	-	40

NB: Misura non comprensiva di filettatura

NB: Length not including thread

2600.D8

PROLUNGA PESANTE
HEAVY EXTENSION



CODICE	Ø	◇	☐
2600D8R031000A	3/8"x10	10	300
2600D8R031500A	3/8"x15	10	300
2600D8R032000A	3/8"x20	10	200
2600D8R032500A	3/8"x25	10	200
2600D8R033000A	3/8"x30	10	180
2600D8R034000A	3/8"x40	10	150
2600D8R035000A	3/8"x50	10	100
2600D8R041000A	1/2"x10	10	200
2600D8R041500A	1/2"x15	10	150
2600D8R042000A	1/2"x20	10	120
2600D8R042500A	1/2"x25	10	120
2600D8R043000A	1/2"x30	10	100
2600D8R044000A	1/2"x40	10	100
2600D8R045000A	1/2"x50	10	80
2600D8R045500A	1/2"x55	10	60
2600D8R046000A	1/2"x60	10	60
2600D8R046500A	1/2"x65	10	40
2600D8R047000A	1/2"x70	5	40
2600D8R048000A	1/2"x80	-	40
2600D8R04B000A	1/2"x100	-	40
2600D8R051000A	3/4"x10	10	150
2600D8R051500A	3/4"x15	10	150
2600D8R052000A	3/4"x20	10	100
2600D8R052500A	3/4"x25	10	80
2600D8R053000A	3/4"x30	10	80
2600D8R054000A	3/4"x40	10	60
2600D8R055000A	3/4"x50	10	50
2600D8R056000A	3/4"x60	10	40

2600.D8

PROLUNGA PESANTE
HEAVY EXTENSION



CODICE	Ø	◇	☐
2600D8R057000A	3/4"x70	-	40
2600D8R058000A	3/4"x80	-	20
2600D8R05B000A	3/4"x100	-	20
2600D8R101000A	1"x10	10	120
2600D8R101500A	1"x15	10	100
2600D8R102000A	1"x20	10	70
2600D8R102500A	1"x25	10	50
2600D8R103000A	1"x30	5	50
2600D8R104000A	1"x40	5	40
2600D8R105000A	1"x50	5	40

NB: Misura non comprensiva di filettatura

NB: Length not including thread

2600.D8.B PROLUNGA PESANTE CROMATA LUCIDA
POLISHED CHROME-PLATED HEAVY EXTENSION



CODICE	Ø	◇	☐
2600D8B031000A	3/8"x10	10	300
2600D8B031500A	3/8"x15	10	300
2600D8B032000A	3/8"x20	10	200
2600D8B032500A	3/8"x25	10	200
2600D8B033000A	3/8"x30	10	180
2600D8B034000A	3/8"x40	10	150
2600D8B035000A	3/8"x50	10	100
2600D8B041000A	1/2"x10	10	200
2600D8B041500A	1/2"x15	10	150
2600D8B042000A	1/2"x20	10	120
2600D8B042500A	1/2"x25	10	120
2600D8B043000A	1/2"x30	10	100
2600D8B044000A	1/2"x40	10	100
2600D8B045000A	1/2"x50	10	80
2600D8B045500A	1/2"x55	10	60
2600D8B046000A	1/2"x60	10	60
2600D8B046500A	1/2"x65	10	40
2600D8B047000A	1/2"x70	5	40
2600D8B048000A	1/2"x80	-	40
2600D8B04B000A	1/2"x100	-	40
2600D8B051000A	3/4"x10	10	150
2600D8B051500A	3/4"x15	10	150
2600D8B052000A	3/4"x20	10	100
2600D8B052500A	3/4"x25	10	80
2600D8B053000A	3/4"x30	10	80
2600D8B054000A	3/4"x40	10	60
2600D8B055000A	3/4"x50	10	50
2600D8B056000A	3/4"x60	10	40

2600.D8.B PROLUNGA PESANTE CROMATA LUCIDA
POLISHED CHROME-PLATED HEAVY EXTENSION



CODICE	Ø	◇	☐
2600D8B057000A	3/4"x70	-	40
2600D8B058000A	3/4"x80	-	20
2600D8B05B000A	3/4"x100	-	20
2600D8B101000A	1"x10	10	120
2600D8B101500A	1"x15	10	100
2600D8B102000A	1"x20	10	70
2600D8B102500A	1"x25	10	50
2600D8B103000A	1"x30	5	50
2600D8B104000A	1"x40	5	40
2600D8B105000A	1"x50	5	40

NB: Misura non comprensiva di filettatura

NB: Length not including thread

2600.F5

PROLUNGA ESAGONALE
HEXAGONAL EXTENSION



CODICE	Ø	◇	☐
2600F5H041000H	1/2"x10	10	200
2600F5H041500H	1/2"x15	10	200
2600F5H042000H	1/2"x20	10	150
2600F5H042500H	1/2"x25	10	150
2600F5H043000H	1/2"x30	10	120
2600F5H044000H	1/2"x40	10	100
2600F5H045000H	1/2"x50	10	80
2600F5H046000H	1/2"x60	10	80

2600.F5.C

PROLUNGA ESAGONALE CROMATA
CHROME-PLATED HEXAGONAL EXTENSION



CODICE	Ø	◇	☐
2600F5C041000H	1/2"x10	10	200
2600F5C041500H	1/2"x15	10	200
2600F5C042000H	1/2"x20	10	150
2600F5C042500H	1/2"x25	10	150
2600F5C043000H	1/2"x30	10	120
2600F5C044000H	1/2"x40	10	100
2600F5C045000H	1/2"x50	10	80
2600F5C046000H	1/2"x60	10	80

2600.F7

PROLUNGA STAMPATA
HOT-STAMPED EXTENSION



CODICE	Ø	◇	☐
2600F7H041000H	1/2"x10	10	200
2600F7H041500H	1/2"x15	10	200
2600F7H042000H	1/2"x20	10	150
2600F7H042500H	1/2"x25	10	150
2600F7H043000H	1/2"x30	10	100
2600F7H044000H	1/2"x40	10	100
2600F7H045000H	1/2"x50	10	80

2600.F7.C

PROLUNGA STAMPATA CROMATA
CHROME-PLATED HOT-STAMPED EXTENSION



CODICE	Ø	◇	☐
2600F7C041000H	1/2"x10	10	200
2600F7C041500H	1/2"x15	10	200
2600F7C042000H	1/2"x20	10	150
2600F7C042500H	1/2"x25	10	150
2600F7C043000H	1/2"x30	10	100
2600F7C044000H	1/2"x40	10	100
2600F7C045000H	1/2"x50	10	80

2600.D9 PORTAGOMMA MASCHIO
MALE HOSE ADAPTOR

CODICE	i	Ø	◇	☐
2600D9H011000H		1/8"x10	10	400
2600D9H011400H		1/8"x14	10	350
2600D9H021000H		1/4"x10	10	400
2600D9H021400H		1/4"x14	10	350
2600D9H031000H		3/8"x10	10	300
2600D9H031200H		3/8"x12	10	300
2600D9H031400H		3/8"x14	10	300
2600D9H040800H		1/2"x8	10	250
2600D9H041000H		1/2"x10	10	250
2600D9H041200H		1/2"x12	10	250
2600D9H041400H		1/2"x14	10	200
2600D9H041600H		1/2"x16	10	200
2600D9H041800H		1/2"x18	10	200
2600D9H042000H		1/2"x20	10	150
2600D9H042500H		1/2"x25	10	100
2600D9H052000H		3/4"x20	10	100
2600D9H052500H		3/4"x25	10	100
2600D9H102500H		1"x25	10	60
2600D9H103000H		1"x30	10	50
2600D9H123000H	Tipo Roma	1"1/4x30	-	30
2600D9H123200H	Tipo Roma	1"1/4x32	-	30
2600D9H123500H	Tipo Roma	1"1/4x35	-	20
2600D9H124000H	Tipo Roma	1"1/4x40	-	20
2600D9H144000H	Tipo Roma	1"1/2x40	-	20
2600D9H144500H	Tipo Roma	1"1/2x45	-	20
2600D9H205000H	Tipo Roma	2"x50	-	10
2600D9H246000H	Tipo Roma	2"1/2x60	-	8
2600D9H308000H	Tipo Roma	3"x80	-	6

2600.D9 PORTAGOMMA MASCHIO
MALE HOSE ADAPTOR

CODICE	i	Ø	◇	☐
2600D9H40B000H	Tipo Roma	4"x100	-	2

2600.D9.C PORTAGOMMA MASCHIO CROMATO
CHROME-PLATED MALE HOSE ADAPTOR



CODICE	i	Ø	◇	☐
2600D9C011000H		1/8"x10	10	400
2600D9C021000H		1/4"x10	10	400
2600D9C021400H		1/4"x14	10	350
2600D9C031000H		3/8"x10	10	300
2600D9C031400H		3/8"x14	10	300
2600D9C041000H		1/2"x10	10	250
2600D9C041200H		1/2"x12	10	250
2600D9C041400H		1/2"x14	10	200
2600D9C041600H		1/2"x16	10	200
2600D9C041800H		1/2"x18	10	200
2600D9C042000H		1/2"x20	10	150
2600D9C052000H		3/4"x20	10	100
2600D9C052500H		3/4"x25	10	100
2600D9C102500H		1"x25	10	60
2600D9C103000H		1"x30	10	50
2600D9C123500H	Tipo Roma	1"1/4x35	-	20
2600D9C124000H	Tipo Roma	1"1/4x40	-	20
2600D9C144500H	Tipo Roma	1"1/2x45	-	20
2600D9C246000H	Tipo Roma	2"1/2x60	-	8

2600.D9.N PORTAGOMMA MASCHIO NICHELATO
NICKEL-PLATED MALE HOSE ADAPTOR



CODICE	i	Ø	◇	☐
2600D9N011000H		1/8"x10	10	400
2600D9N021000H		1/4"x10	10	400
2600D9N021400H		1/4"x14	10	350
2600D9N031000H		3/8"x10	10	300
2600D9N031200H		3/8"x12	10	300
2600D9N031400H		3/8"x14	10	300
2600D9N041000H		1/2"x10	10	250
2600D9N041200H		1/2"x12	10	250
2600D9N041400H		1/2"x14	10	200
2600D9N041600H		1/2"x16	10	200
2600D9N041800H		1/2"x18	10	200
2600D9N042000H		1/2"x20	10	150
2600D9N042500H		1/2"x25	10	100
2600D9N052000H		3/4"x20	10	100
2600D9N052500H		3/4"x25	10	100
2600D9N102500H		1"x25	10	60
2600D9N103000H		1"x30	10	50
2600D9N123000H	Tipo Roma	1"1/4x30	5	30
2600D9N123500H	Tipo Roma	1"1/4x35	-	20
2600D9N124000H	Tipo Roma	1"1/4x40	-	20
2600D9N144000H	Tipo Roma	1"1/2x40	-	20
2600D9N144500H	Tipo Roma	1"1/2x45	-	20
2600D9N205000H	Tipo Roma	2"x50	-	10
2600D9N246000H	Tipo Roma	2"1/2x60	-	8

2600.F1PORTAGOMMA FEMMINA
FEMALE HOSE ADAPTOR

CODICE	i	Ø	◇	☐
2600F1H011000H		1/8"x10	10	350
2600F1H011400H		1/8"x14	10	300
2600F1H021000H		1/4"x10	10	300
2600F1H021400H		1/4"x14	10	300
2600F1H031000H		3/8"x10	10	250
2600F1H031200H		3/8"x12	10	250
2600F1H031400H		3/8"x14	10	200
2600F1H041000H		1/2"x10	10	200
2600F1H041200H		1/2"x12	10	150
2600F1H041400H		1/2"x14	10	150
2600F1H041600H		1/2"x16	10	150
2600F1H041800H		1/2"x18	10	150
2600F1H042000H		1/2"x20	10	150
2600F1H052000H		3/4"x20	10	100
2600F1H052500H		3/4"x25	10	100
2600F1H102500H		1"x25	10	60
2600F1H103000H		1"x30	10	50
2600F1H123000H	Tipo Roma	1"1/4x30	-	40
2600F1H123500H	Tipo Roma	1"1/4x35	-	25
2600F1H144000H	Tipo Roma	1"1/2x40	-	25
2600F1H205000H	Tipo Roma	2"x50	-	10

2600.F1.CPORTAGOMMA FEMMINA CROMATO
CHROME-PLATED FEMALE HOSE ADAPTOR

CODICE	i	Ø	◇	☐
2600F1C011400H		1/8"x14	10	300
2600F1C021000H		1/4"x10	10	300
2600F1C021400H		1/4"x14	10	300
2600F1C031000H		3/8"x10	10	250
2600F1C031200H		3/8"x12	10	250
2600F1C031400H		3/8"x14	10	200
2600F1C041000H		1/2"x10	10	200
2600F1C041200H		1/2"x12	10	150
2600F1C041400H		1/2"x14	10	150
2600F1C041600H		1/2"x16	10	150
2600F1C041800H		1/2"x18	10	150
2600F1C042000H		1/2"x20	10	150
2600F1C052000H		3/4"x20	10	100
2600F1C052500H		3/4"x25	10	100
2600F1C123000H	Tipo Roma	1"1/4x30	-	40
2600F1C123500H	Tipo Roma	1"1/4x35	5	25
2600F1C144000H	Tipo Roma	1"1/2x40	-	25
2600F1C205000H	Tipo Roma	2"x50	-	10

2600.F1.NPORTAGOMMA FEMMINA NICHELATO
NICKEL-PLATED FEMALE HOSE ADAPTOR

CODICE	i	Ø	◇	☐
2600F1N021000H		1/4"x10	10	300
2600F1N021400H		1/4"x14	10	300
2600F1N031000H		3/8"x10	10	250
2600F1N031200H		3/8"x12	10	250
2600F1N031400H		3/8"x14	10	200
2600F1N041000H		1/2"x10	10	200
2600F1N041200H		1/2"x12	10	150
2600F1N041400H		1/2"x14	10	150
2600F1N041600H		1/2"x16	10	150
2600F1N041800H		1/2"x18	10	150
2600F1N042000H		1/2"x20	10	150
2600F1N052000H		3/4"x20	10	100
2600F1N052500H		3/4"x25	10	100
2600F1N102500H		1"x25	10	60
2600F1N103000H		1"x30	10	50
2600F1N123000H	Tipo Roma	1"1/4x30	-	40
2600F1N123500H	Tipo Roma	1"1/4x35	-	25
2600F1N144000H	Tipo Roma	1"1/2x40	-	25
2600F1N205000H	Tipo Roma	2"x50	-	10

2600.F7.NPROLUNGA STAMPATA NICHELATA
NICKEL-PLATED HOT-STAMPED EXTENSION

CODICE	Ø	◇	☐
2600F7N041000H	1/2"x10	10	200
2600F7N041500H	1/2"x15	10	200
2600F7N042000H	1/2"x20	10	150
2600F7N042500H	1/2"x25	10	150
2600F7N043000H	1/2"x30	10	100
2600F7N044000H	1/2"x40	10	100
2600F7N045000H	1/2"x50	10	80

2600.O9RIDUZIONE ESAGONALE F/M
F/M HEXAGONAL BUSHING

CODICE	Ø	◇	☐
2600O9H040300A	1/2"x3/8"	10	200
2600O9H040400A	1/2"x1/2"	10	200
2600O9H040500A	1/2"x3/4"	10	120
2600O9H050400A	3/4"x1/2"	10	120
2600O9H050500A	3/4"x3/4"	10	120
2600O9H051000A	3/4"x1"	10	80
2600O9H100400A	1"x1/2"	10	80
2600O9H100500A	1"x3/4"	10	80

2600.09.N RIDUZIONE ESAGONALE F/M
F/M HEXAGONAL BUSHING

CODICE	Ø	◇	☐
260009N040300A	1/2"x3/8"	10	200
260009N040400A	1/2"x1/2"	10	200
260009N040500A	1/2"x3/4"	10	120
260009N050400A	3/4"x1/2"	10	120
260009N050500A	3/4"x3/4"	10	120
260009N051000A	3/4"x1"	10	80
260009N100400A	1"x1/2"	10	80
260009N100500A	1"x3/4"	10	80

2700.10 RACCORDO A T MASCHIO
MALE TEE

CODICE	Ø	◇	☐
270010H040404A	1/2"x1/2"x1/2"	10	90
270010H050505A	3/4"x3/4"x3/4"	10	50
270010H101010A	1"x1"x1"	5	30

2700.10.N RACCORDO A T MASCHIO NICHELATO
NICKEL-PLATED MALE TEE

CODICE	Ø	◇	☐
270010N040404A	1/2"x1/2"x1/2"	10	90
270010N050505A	3/4"x3/4"x3/4"	10	50
270010N101010A	1"x1"x1"	5	30

2700.12 RACCORDO A T M/F/M
M/F/M TEE

CODICE	Ø	◇	☐
270012H040404A	1/2"x1/2"x1/2"	10	60

2700.12.N RACCORDO A T M/F/M NICHELATO
NICKEL-PLATED M/F/M TEE

CODICE	Ø	◇	☐
270012N040404A	1/2"x1/2"x1/2"	10	60

2700.13RACCORDO A T RIDOTTO
REDUCED TEE

CODICE	Ø	◇	☐
270013H050405A	3/4"x1/2"x3/4"	10	50
270013H100410A	1"x1/2"x1"	5	20
270013H100510A	1"x3/4"x1"	5	20

2700.13.NRACCORDO A T RIDOTTO NICHELATO
NICKEL-PLATED REDUCED TEE

CODICE	Ø	◇	☐
270013N050405A	3/4"x1/2"x3/4"	10	50
270013N100410A	1"x1/2"x1"	5	20
270013N100510A	1"x3/4"x1"	5	20

2700.13.CRACCORDO A T RIDOTTO CROMATO
CHROME-PLATED REDUCED TEE

CODICE	Ø	◇	☐
270013C050405A	3/4"x1/2"x3/4"	10	50
270013C100410A	1"x1/2"x1"	5	20
270013C100510A	1"x3/4"x1"	5	20

2700.14.BRACCORDO A T FEMMINA CROMATO LUCIDO
POLISHED CHROME-PLATED FEMALE TEE

CODICE	Ø	◇	☐
270014B020202A	1/4"	10	150
270014B030303A	3/8"	10	80
270014B040404A	1/2"	5	60
270014B050505A	3/4"	10	40
270014B101010A	1"	5	20

2700.14.N RACCORDO A T FEMMINA NICHELATO
 NICKEL-PLATED FEMALE TEE

CODICE	Ø	◇	☐
270014N020202A	1/4"	10	150
270014N030303A	3/8"	10	80
270014N040404A	1/2"	10	60
270014N050505A	3/4"	10	40
270014N101010A	1"	5	20
270014N121212A	1"1/4	-	15
270014N141414A	1"1/2	-	12
270014N202020A	2"	-	5

2700.14 RACCORDO A T FEMMINA
 FEMALE TEE

CODICE	Ø	◇	☐
270014H020202A	1/4"	10	150
270014H030303A	3/8"	10	80
270014H040404A	1/2"	10	60
270014H050505A	3/4"	10	40
270014H101010A	1"	5	20
270014H121212A	1"1/4	-	15
270014H141414A	1"1/2	-	12
270014H202020A	2"	-	5
270014H242424A	2"1/2	-	3
270014H303030A	3"	-	2
270014H404040A	4"	-	-

2700.15.N RACCORDO A T F/M/F NICHELATO
 NICKEL-PLATED F/M/F TEE

CODICE	Ø	◇	☐
270015N040404A	1/2"x1/2"x1/2"	10	60
270015N050405A	3/4"x1/2"x3/4"	-	-
270015N050505A	3/4"x3/4"x3/4"	5	30
270015N101010A	1"x1"x1"	5	15

2700.17 RACCORDO A T F/F/M
F/F/M TEE



CODICE	Ø	◇	📦
270017H040404A	1/2"x1/2"x1/2"	10	60
270017H050505A	3/4"x3/4"x3/4"	10	40

2700.17.N RACCORDO A T F/F/M NICHELATO
NICKEL-PLATED F/F/M TEE



CODICE	Ø	◇	📦
270017N040404A	1/2"x1/2"x1/2"	10	60
270017N050505A	3/4"x3/4"x3/4"	10	40

2700.17.B RACCORDO A T F/F/M CROMATO BRILLANTE
POLISHED CHROME-PLATED F/F/M TEE



CODICE	Ø
270017B040404A	1/2"x1/2"x1/2"
270017B050505A	3/4"x3/4"x3/4"

2700.20 ANGOLO M/M
M/M ELBOW



CODICE	Ø	◇	📦
270020H040400A	1/2"x1/2"	10	120
270020H050500A	3/4"x3/4"	10	80
270020H101000A	1"x1"	5	50

2700.15 RACCORDO A T F/M/F
F/M/F TEE



CODICE	Ø	◇	📦
270015H040404A	1/2"x1/2"x1/2"	10	60
270015H050405A	3/4"x1/2"x3/4"	-	-
270015H050505A	3/4"x3/4"x3/4"	5	30
270015H101010A	1"x1"x1"	5	15

2700.23 ATTACCO A MURO F/F CON FLANGIA 2 FORI
F/F WALLPLATE ELBOW WITH 2 HOLES



CODICE	Ø	◇	☐
270023H040400A	1/2"	10	60

2700.23.C ATTACCO A MURO F/F CROMATO CON FLANGIA 2 FORI
CHROME-PLATED F/F WALLPLATE ELBOW WITH 2 HOLES



CODICE	Ø	◇	☐
270023C040400A	1/2"	10	60

2700.23.N ATTACCO A MURO F/F NICHELATO CON FLANGIA 2 FORI
NICKEL-PLATED F/F WALLPLATE ELBOW WITH 2 HOLES



CODICE	Ø	◇	☐
270023N040400A	1/2"	10	60

2700.24 ANGOLO M/F
M/F ELBOW



CODICE	Ø	◇	☐
270024H020200A	1/4"	10	150
270024H030300A	3/8"	10	120
270024H040400A	1/2"	10	80
270024H050500A	3/4"	10	40
270024H101000A	1"	5	30
270024H121200A	1"1/4	-	15
270024H141400A	1"1/2	-	10
270024H202000A	2"	-	5
270024H242400A	2"1/2	-	3
270024H303000A	3"	-	2

2700.24.B ANGOLO M/F CROMATO LUCIDO
POLISHED CHROME-PLATED M/F ELBOW



CODICE	Ø	◇	☐
270024B020200A	1/4"	10	150
270024B030300A	3/8"	10	120
270024B040400A	1/2"	10	80
270024B050500A	3/4"	10	40
270024B101000A	1"	5	30

2700.24.N ANGOLO M/F NICHELATO
NICKEL-PLATED M/F ELBOW



CODICE	Ø	◇	☐
270024N020200A	1/4"	10	150
270024N030300A	3/8"	10	120
270024N040400A	1/2"	10	80
270024N050500A	3/4"	10	40
270024N101000A	1"	5	30
270024N121200A	1"1/4	-	15
270024N141400A	1"1/2	-	10
270024N202000A	2"	-	5

2700.25 ANGOLO F/F
F/F ELBOW



CODICE	Ø	◇	☐
270025H020200A	1/4"	10	170
270025H030300A	3/8"	10	150
270025H040400A	1/2"	10	90
270025H050500A	3/4"	10	60
270025H101000A	1"	5	30
270025H121200A	1"1/4	-	20
270025H141400A	1"1/2	-	15
270025H202000A	2"	-	5
270025H242400A	2"1/2	-	4
270025H303000A	3"	-	2

2700.20.N ANGOLO MASCHIO NICHELATO
NICKEL-PLATED MALE ELBOW



CODICE	Ø	◇	☐
270020N040400A	1/2"x1/2"	10	120
270020N050500A	3/4"x3/4"	10	80
270020N101000A	1"x1"	5	50

2700.25.B ANGOLO F/F CROMATO LUCIDO
POLISHED CHROME-PLATED F/F ELBOW



CODICE	Ø	◇	☐
270025B020200A	1/4"	10	170
270025B030300A	3/8"	10	150
270025B040400A	1/2"	10	90
270025B050500A	3/4"	10	60
270025B101000A	1"	5	30

2700.25.C ANGOLO F/F CROMATO
CHROME-PLATED F/F ELBOW



CODICE	Ø	☐
270025C121200A	1"1/4	20
270025C141400A	1"1/2	15
270025C202000A	2"	5

2700.25.N ANGOLO F/F NICHELATO
NICKEL-PLATED F/F ELBOW



CODICE	Ø	◇	☐
270025N020200A	1/4"	10	170
270025N030300A	3/8"	10	150
270025N040400A	1/2"	10	90
270025N050500A	3/4"	10	60
270025N101000A	1"	5	30
270025N121200A	1"1/4	-	20
270025N141400A	1"1/2	-	15
270025N202000A	2"	-	5

2700.26 ANGOLO RIDOTTO M/F
M/F REDUCED ELBOW



CODICE	Ø	◇	☐
270026H050400A	3/4"Fx1/2"m	10	60

2700.29 ANGOLO RIDOTTO F/F
REDUCED ELBOW F/F



CODICE	Ø	◇	☐
270029H050400A	3/4"x1/2"	10	60
270029H100500A	1"x3/4"	5	40

2700.26.N M/F ANGOLO RIDOTTO NICHELATO
NICKEL-PLATED REDUCED ELBOW



CODICE	Ø	◇	☐
270026N050400A	3/4"Fx1/2"m	10	60

2700.29.N ANGOLO RIDOTTO F/F NICHELATO
NICKEL-PLATED REDUCED ELBOW F/F



CODICE	Ø	◇	☐
270029N050400A	3/4"x1/2"	10	60
270029N100500A	1"x3/4"	5	40

2700.F8 ANGOLO M/F
M/F ELBOW



CODICE	Ø	◇	☐
2700F8H030300A	3/8"	10	120
2700F8H040400A	1/2"	5	100
2700F8H050500A	3/4"	10	50
2700F8H101000A	1"	5	30
2700F8H121200A	1"1/4	-	20
2700F8H141400A	1"1/2	-	15
2700F8H202000A	2"	-	6

2700.F8.N ANGOLO M/F NICHELATO
NICKEL-PLATED M/F ELBOW



CODICE	Ø	◇	☐
2700F8N030300A	3/8"	10	120
2700F8N040400A	1/2"	10	100
2700F8N050500A	3/4"	10	50
2700F8N101000A	1"	5	30
2700F8N121200A	1"1/4	-	20

2700.F8.B ANGOLO M/F CROMATO LUCIDO
POLISHED CHROME-PLATED M/F ELBOW



CODICE	Ø	◇	☐
2700F8B030300A	3/8"	10	120
2700F8B040400A	1/2"	5	100
2700F8B050500A	3/4"	10	50
2700F8B101000A	1"	5	30

2700.F9 ANGOLO M/M
M/M ELBOW



CODICE	Ø	◇	☐
2700F9H030300A	3/8"	10	100
2700F9H040400A	1/2"	10	80
2700F9H050500A	3/4"	10	40
2700F9H101000A	1"	5	30

2700.F9.N ANGOLO MASCHIO NICHELATO
NICKEL-PLATED MALE ELBOW



CODICE	Ø	◇	☐
2700F9N030300A	3/8"	10	100
2700F9N040400A	1/2"	10	80
2700F9N050500A	3/4"	10	40
2700F9N101000A	1"	5	30

2700.F9.B ANGOLO MASCHIO CROMATO LUCIDO
POLISHED CHROME-PLATED M/M ELBOW



CODICE	Ø	◇	☐
2700F9B030300A	3/8"	10	100
2700F9B040400A	1/2"	10	80
2700F9B050500A	3/4"	10	40
2700F9B101000A	1"	5	30

2700.36.N CROCE FEMMINA NICHELATA
NICKEL-PLATED FEMALE CROSS



CODICE	Ø	◇	☐
270036N040000A	1/2"	10	50
270036N050000A	3/4"	10	30
270036N100000A	1"	5	20
270036N120000A	1 1/4"	-	10
270036N140000A	1 1/2"	-	8
270036N200000A	2"	-	6

2700.E2 GOMITO 45° M/F
45° M/F ELBOW



CODICE	Ø	◇	☐
2700E2H040400H	1/2"	10	100
2700E2H050500H	3/4"	10	50
2700E2H101000H	1"	5	30
2700E2H121200H	1 1/4"	-	20
2700E2H141400H	1 1/2"	-	15
2700E2H202000H	2"	-	6

2700.36 CROCE FEMMINA
FEMALE CROSS



CODICE	Ø	◇	☐
270036H040000A	1/2"	10	50
270036H050000A	3/4"	10	30
270036H100000A	1"	5	20
270036H120000A	1 1/4"	-	10
270036H140000A	1 1/2"	-	8
270036H200000A	2"	-	6

2700.G1 MORSETTO PER TUBO FERRO
HOLDFAST FOR IRON PIPE



CODICE	Ø	☐
2700G1H040400A	1/2"x1/2"	25
2700G1H050400A	3/4"x1/2"	25

2700.K4 GOMITO 45° F/F
45° F/F ELBOW



CODICE	Ø	◇	☐
2700K4H040400H	1/2"	10	80
2700K4H050500H	3/4"	10	60
2700K4H101000H	1"	5	30
2700K4H121200H	1 1/4"	-	20
2700K4H141400H	1 1/2"	-	15
2700K4H202000H	2"	-	10

2700.N4 RACCORDO 5 VIE
FITTING 5 EXITS



CODICE	Ø	◇	☐
2700N4H100272A	1"x1/4" H=72	5	25
2700N4H100282A	1"x1/4" H=82	5	25
2700N4H100292A	1"x1/4" H=92	5	25

2700.N5 RACCORDO 3 VIE
FITTING 3 EXITS



CODICE	Ø	◇	☐
2700N5H101072A	1" H=72	5	25
2700N5H101082A	1" H=82	5	-
2700N5H101092A	1" H=92	5	-

2700.A1 RACCORDO DIRITTO M/F RADIATORE CON SEDE
PIANA GUARNIZIONE VERDE
M/F STRAIGHT FITTING FOR RADIATOR WITH FLAT
CONNECTION AND GREEN RING



CODICE	Ø	◇	☐
2700A1H040400A	1/2"	10	100
2700A1H050500A	3/4"	10	50
2700A1H101000A	1"	5	30
2700A1H121200A	1 1/4"	-	20
2700A1H141400A	1 1/2"	-	10
2700A1H202000A	2"	-	7

2700.A2 RACCORDO DIRITTO M/F PER RADIATORE
M/F STRAIGHT FITTING FOR RADIATOR



CODICE	Ø	◇	☐
2700A2H030300A	3/8"	10	120
2700A2H040400A	1/2"	10	100
2700A2H050500A	3/4"	10	50
2700A2H101000A	1"	5	30

2700.A2.N RACCORDO DIRITTO M/F NICHELATO PER RADIATORE
NICKEL-PLATED M/F STRAIGHT FITTING FOR RADIATOR



CODICE	Ø	◇	☐
2700A2N030300A	3/8"	10	120
2700A2N040400A	1/2"	10	100
2700A2N050500A	3/4"	10	50
2700A2N101000A	1"	5	30

2700.C7 KIT DUE PEZZI: DADO, BOCCHETTONE E FEMMINA PER POMPE
KIT NUT, FLAT NIPPLE AND FEMALE FOR PUMPS



CODICE	Ø	☐
2700C7H041000A	1/2"x1"	24
2700C7H051200A	3/4"x1"1/4	24
2700C7H122000A	1"1/4x2"	12
2700C7H140400H	1/2"x1"1/2	12
2700C7H140500H	3/4"x1"1/2	12
2700C7H141000H	1"x1"1/2	12
2700C7H142200A	1"1/2x2"1/4	-
2700C7H202400A	2"x2"1/2	6

2700.A4.N ANGOLO M/F NICHELATO PER RADIATORE
NICKEL-PLATED M/F ELBOW FOR RADIATOR



CODICE	Ø	◇	☐
2700A4N040400A	1/2"	10	60
2700A4N050500A	3/4"	10	30
2700A4N101000A	1"	5	20

2700.A4 ANGOLO M/F PER RADIATORE
M/F ELBOW FOR RADIATOR



CODICE	Ø	◇	☐
2700A4H040400A	1/2"	10	60
2700A4H050500A	3/4"	10	30
2700A4H101000A	1"	5	20

2700.R5 ANGOLO M/F RADIATORE CON SEDE PIANA
GUARNIZIONE VERDE
M/F ELBOW FITTING FOR RADIATOR WITH FLAT
CONNECTION AND GREEN RING



CODICE	Ø	◇	☐
2700R5H040400A	1/2"	10	60
2700R5H050500A	3/4"	10	30
2700R5H101000A	1"	5	20
2700R5H121200A	1"1/4	-	15
2700R5H141400A	1"1/2	-	10
2700R5H202000A	2"	-	4

2700.A6 RACCORDO DIRITTO M/M PER RADIATORE
M/M STRAIGHT FITTING FOR RADIATOR



CODICE	Ø	◇	☐
2700A6H040400A	1/2"	10	90
2700A6H050500A	3/4"	10	40
2700A6H101000A	1"	5	20

2700.A6.N RACCORDO DIRITTO M/M NICHELATO PER
RADIATORE
NICKEL-PLATED M/M STRAIGHT FITTING FOR
RADIATOR



CODICE	Ø	◇	☐
2700A6N040400A	1/2"	10	90
2700A6N050500A	3/4"	10	40
2700A6N101000A	1"	5	20

2700.A7 RACCORDO DIRITTO TRE PEZZI F/F
F/F 3 PIECES STRAIGHT FITTING FOR RADIATOR



CODICE	Ø	◇	☐
2700A7H040400A	1/2"	10	60
2700A7H050500A	3/4"	10	40
2700A7H101000A	1"	5	20
2700A7H121200A	1"1/4	-	20
2700A7H141400A	1"1/2	-	15
2700A7H202000A	2"	-	8

2700.A7.N RACCORDO DIRITTO TRE PEZZI F/F NICHELATO
NICKEL-PLATED F/F 3 PIECES STRAIGHT FITTING FOR RADIATOR



CODICE	Ø	◇	☐
2700A7N040400A	1/2"	10	60
2700A7N050500A	3/4"	10	40
2700A7N101000A	1"	5	20
2700A7N121200A	1"1/4	-	20
2700A7N141400A	1"1/2	-	15
2700A7N202000A	2"	-	8

2700.I2.N RACCORDO DIRITTO M/F NICHELATO CON O-RING
PER RADIATORE
NICKEL-PLATED M/F STRAIGHT FITTING FOR RADIATOR WITH O-RING



CODICE	Ø	◇	☐
2700I2N030300A	3/8"	10	120
2700I2N040400A	1/2"	10	100
2700I2N050500A	3/4"	10	50
2700I2N101000A	1"	5	30
2700I2N121200A	1"1/4	-	20
2700I2N141400A	1"1/2	-	10
2700I2N202000A	2"	-	7

2700.I6 RACCORDO DIRITTO M/M CON O-RING PER RADIATORE
M/M STRAIGHT FITTING WITH O-RING FOR RADIATOR



CODICE	Ø	◇	☐
2700I6H040400A	1/2"	10	90
2700I6H050500A	3/4"	10	40
2700I6H101000A	1"	5	20

2700.I2 RACCORDO DIRITTO M/F CON O-RING PER RADIATORE
M/F STRAIGHT FITTING FOR RADIATOR WITH O-RING



CODICE	Ø	◇	☐
2700I2H030300A	3/8"	10	120
2700I2H040400A	1/2"	10	100
2700I2H050500A	3/4"	10	50
2700I2H101000A	1"	5	30
2700I2H121200A	1"1/4	-	20
2700I2H141400A	1"1/2	-	10
2700I2H202000A	2"	-	7

2700.I4 ANGOLO M/F CON O-RING PER RADIATORE
M/F ELBOW FOR RADIATOR WITH O-RING



CODICE	Ø	◇	☐
2700I4H040400A	1/2"	10	60
2700I4H050500A	3/4"	10	30
2700I4H101000A	1"	5	20
2700I4H121200A	1"1/4	-	15
2700I4H141400A	1"1/2	-	10
2700I4H202000A	2"	-	4

2700.I4.C ANGOLO M/F CON O-RING PER RADIATORE CROMATO
NICKEL-PLATED M/F ELBOW FOR RADIATOR WITH O-RING

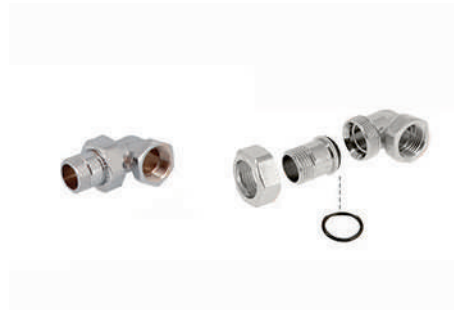

CODICE	Ø	◇	☐
2700I4B040400A	1/2"	10	60
2700I4B050500A	3/4"	10	30
2700I4B101000A	1"	5	20
2700I4C040400A	1/2"	10	60
2700I4C050500A	3/4"	10	30
2700I4C101000A	1"	5	20

2700.I6.N RACCORDO DIRITTO M/M NICHELATO CON O-RING PER RADIATORE
M/M NICKEL-PLATED STRAIGHT FITTING WITH O-RING FOR RADIATOR



CODICE	Ø	◇	☐
2700I6N040400A	1/2"	10	90
2700I6N050500A	3/4"	10	40
2700I6N101000A	1"	5	20

2700.I4.N ANGOLO M/F NICHELATO CON O-RING PER RADIATORE
 NICKEL-PLATED M/F ELBOW FOR RADIATOR WITH O-RING



CODICE	Ø	◇	☐
2700I4N040400A	1/2"	10	60
2700I4N050500A	3/4"	10	30
2700I4N101000A	1"	5	20
2700I4N121200A	1"1/4	-	15
2700I4N141400A	1"1/2	-	10
2700I4N202000A	2"	-	4

GU.005 GUARNIZIONE
 FLAT WASHER



CODICE	Ø
GU0050H241618H	24x16x1,8
GU0050H302118H	30x21x1,8
GU0050H393018H	39x30x1,8
GU0050H443618H	44,5x36x1,8
GU0050H564302H	56x43x1,8
GU0050H716102H	71,5x61x2

2700.E1 DADO, CODOLO E GUARNIZIONE PER CONTATORI
 NUT, TAIL AND FLAT GASKET FOR COUNTER



CODICE	Ø	◇	☐
2700E1H050400H	3/4"x1/2"	2	200
2700E1H100500H	1"x3/4"	2	100
2700E1H121000H	1"1/4x1"	2	50
2700E1H141200H	1"1/2x1"1/4	-	30
2700E1H201400H	2"x1"1/2	-	20

2700.53 RACCORDO DIRITTO PROLUNGATO PER CASSONE
 BIN LONG STRAIGHT FITTING



CODICE	Ø	☐
270053H040000H	1/2"	40
270053H050000H	3/4"	30
270053H100000H	1"	16
270053H120000H	1"1/4	10
270053H140000H	1"1/2	10
270053H200000H	2"	6

2700.54 RACCORDO DIRITTO CON PILETTA PER CASSONE
BIN STRAIGHT FITTING WITH WAIST



CODICE	Ø	
270054H040000H	1/2" DRAIN 3/8"	60
270054H050000H	3/4" DRAIN 1/2"	30
270054H100000H	1" DRAIN 3/4"	20
270054H120000H	1"1/4 DRAIN 1"	12
270054H140000H	1"1/2 DRAIN 1"1/4	8

2700.G2 DADO E BOCCHETTONE MASCHIO CON SEDE PIANA
KIT NUT AND MALE FLAT NIPPLE WITH FLAT
CONNECTION



CODICE	Ø		
2700G2H040500A	1/2"x3/4"	10	100
2700G2H051000A	3/4"x1"	10	50
2700G2H101200A	1"x1"1/4	5	40
2700G2H121400A	1"1/4x1"1/2	5	25
2700G2H142000A	1"1/2x2"	5	15
2700G2H202400A	2"x2"1/2	2	8

2700.U7 RACCORDO DIRITTO TRE PEZZI F/F SEDE PIANA
F/F 3 PIECES STRAIGHT FITTING-FLAT SEAT



CODICE	Ø
2700U7H040400A	1/2"
2700U7H050500A	3/4"
2700U7H101000A	1"

2800.03 RACCORDO DIRITTO RIDOTTO CONICO - ISO 7
OMOLOGATO GAS
CONICAL REDUCED STRAIGHT FITTING - ISO 7 (FOR
GAS)



CODICE	Ø	◇	☐
280003H040300H	1/2"x3/8"	10	180
280003H050400H	3/4"x1/2"	10	100
280003H100400H	1"x1/2"	10	80
280003H100500H	1"x3/4"	10	70
280003H121000H	1"1/4x1"	-	30
280003H141000H	1"1/2x1"	5	40
280003H141200H	1"1/2x1"1/4	5	30
280003H201200H	2"x1"1/4	-	30
280003H201400H	2"x1"1/2	-	30

2800.00 RACCORDO DIRITTO CONICO - ISO 7 OMOLOGATO
GAS
DOUBLE STRAIGHT FITTING - ISO7 (FOR GAS)



CODICE	Ø	◇	☐
280000H030300H	3/8"	10	350
280000H040400H	1/2"	10	150
280000H050500H	3/4"	10	100
280000H101000H	1"	10	50
280000H121200H	1"1/4	-	30
280000H141400H	1"1/2	-	30
280000H202000H	2"	-	15

2800.F8 ANGOLO M/F-FILETTO CONICO ISO 7
M/F ELBOW-CONICAL THREAD ISO 7



CODICE	Ø	◇	☐
2800F8H030300A	3/8"x3/8"	10	120
2800F8H040400A	1/2"x1/2"	10	100
2800F8H050500A	3/4"x3/4"	10	50
2800F8H101000A	1"x1"	5	30
2800F8H121200A	1"1/4x1"1/4	-	20

2800.44 RIDUZIONE ESAGONALE M/F-FILETTO CONICO ISO 7
M/F HEXAGONAL BUSHING-CONICAL THREAD ISO 7



CODICE	Ø	◇	☐
280044H040300H	1/2"x3/8"	10	300
280044H050300H	3/4"x3/8"	10	200
280044H050400H	3/4"x1/2"	10	200
280044H100300H	1"x3/8"	10	100
280044H100400H	1"x1/2"	10	100
280044H100500H	1"x3/4"	10	100
280044H120400H	1"1/4x1/2"	10	70
280044H120500H	1"1/4x3/4"	10	70
280044H121000H	1"1/4x1"	10	70



SERIE 2600-2700 DZR

LINE 2600-2700 DZR



Raccordi filettati in ottone CW602N

CW602N Brass threaded fittings

I raccordi filettati della SERIE 2600 DZR e della SERIE 2700 DZR sono realizzati interamente in ottone CW602N di elevata qualità. La filettatura è conforme alla norma UNI EN ISO 228-1:2003.

Sono utilizzabili in impianti idrico-sanitari per adduzione di acqua calda e fredda, in impianti di riscaldamento ed in ogni tipo di installazione idraulica, domestica, commerciale, industriale, agricola e generalmente con qualsiasi tipologia di fluido non corrosivo.

Fittings of LINE 2600/2700 DZR are made of high-quality brass (CW602N). Thread complies with UNI EN ISO 228-1:2003.

They are suitable for hot and cold water in sanitary and heating installations and in any kind of sanitary installation such as domestic, commercial, industry and farming, and with any type of non-corrosive fluid.

VANTAGGI

- Resistenza alla dezincificazione
- Ottima resistenza alle alte temperature e agli agenti atmosferici
- Installazione rapida e sicura
- Dotati di sede per chiave e zigrinatura per un montaggio semplice e agevole
- Utilizzabili per acqua e per aria compressa
- Materie prime impiegate di alta qualità [UBA LIST]
- Lega di ottone CW602N conforme alle norme EN 12165

ADVANTAGES

- *Resistance to dezincification*
- *Excellent resistance to high temperatures and atmospheric agents*
- *Quick and safe installation*
- *Equipped with key seat and knurling for simple and easy assembly*
- *Suitable for water and compressed air*
- *Raw materials complying with UBA LIST*
- *CW602N brass complying with EN 12165 standard*

CAMPI DI APPLICAZIONI E PRESTAZIONI FIELDS OF APPLICATION

APPLICAZIONI APPLICATIONS		T. min.	T. max	Press.max Max. pressure
	acqua potabile drinking water	-20°C	+120°C	16 bar
	acqua calda sanitaria sanitary hot water	-20°C	+120°C	16 bar
	raffrescamento cooling	-20°C	+120°C	16 bar
	radiatori radiators	-20°C	+120°C	16 bar
	irrigazione irrigation	-20°C	+120°C	16 bar
	aria compressa compressed air	-20°C	+120°C	16 bar
	-20°C: solo con liquido antigelo, glicole, in % max del 30% -20°C: only with antifreeze liquid (glycol) in % max of 30%			

NORMATIVE

- UNI EN 1254-4

I raccordi sono conformi alla norma UNI EN 1254-4:
"Raccordi combinanti altri terminali di connessione con terminali di tipo capillare o a compressione."

- UNI EN ISO 228-1:2003

Tutte le filettature sono conformi alla norma UNI EN ISO 228-1:2003: "Filettatura di tubazioni per accoppiamento non a tenuta sul filetto".

- D.M. 174 (06/04/2004)

I materiali utilizzati sono conformi al Decreto Ministeriale n° 174 del 06/04/2004 [Regolamento concernente i materiali e gli oggetti che possono essere utilizzati negli impianti fissi di captazione, trattamento, adduzione e distribuzione delle acque destinate al consumo umano].

- Conforme a 4MS, UBA List (gruppo BC), DIN 50930/6 Dir. 2011/65/UE, 6C allegato III (RhOSII)

- UNI EN 10255:2007

Tubi di acciaio non legato adatti alla saldatura e alla filettatura - Condizioni tecniche di fornitura.

REGULATIONS

- UNI EN 1254-4

Fittings comply with UNI EN 1254-4 law: "Fittings combined with other coupling capillary or compression ends"

- UNI EN ISO 228-1:2003

Threads complies with UNI EN ISO 228-1:2003 law: "Piping thread for coupling not with tightness on the thread".

- D.M. 174 (06/04/2004)

Raw materials used are of high quality and comply with the Ministerial Decree N°174 dated 06/04/2004 concerning the materials and the items used in fixed installations for water collection, treatment and supply.

- Comply with 4MS, UBA List (BC group), DIN 50930/6 Dir. 2011/65/UE, 6C attachment III (RhOSII).

- UNI EN 10255:2007

Non-Alloy steel tubes suitable for welding and threading - Technical delivery conditions.

CERTIFICAZIONI CERTIFICATIONS

STATO COUNTRY	CERTIFICAZIONE CERTIFICATION	STATO COUNTRY	CERTIFICAZIONE CERTIFICATION	STATO COUNTRY	CERTIFICAZIONE CERTIFICATION
					
					
					

ISTRUZIONI DI MONTAGGIO ASSEMBLY INSTRUCTIONS

Posizionare sul raccordo uno strato di materiale isolante (no canapa) per consentire una miglior tenuta sull'attacco.

Place over the fitting a lay of insulating material (no hemp) in order to obtain a better tightness on the coupling.



Verificare che non vi sia eccedenza di materiale aggiunto per prevenire possibili rotture per l'eccessivo serraggio.

Please check if there isn't an excess of the above mentioned coat, in order to prevent possible breakings caused by excessive screwing.



Collegare il raccordo con il circuito facendo attenzione a non eccedere con il serraggio del pezzo.

Verificare la filettatura del raccordo e inserire il tubo per la lunghezza massima pari alla filettatura, senza provocare deformazione del raccordo.

Connect the fitting with the circuit. Pay attention to not exceeding in tightening.

Please check fitting thread length and screw the pipe not more than this length. Be sure to avoid fitting deformation.



2600.00.V RACCORDO DIRITTO DOPPIO
DOUBLE STRAIGHT FITTING



CODICE	Ø	◇	☐
260000V040400H	1/2"	10	200
260000V050500H	3/4"	10	120
260000V101000H	1"	10	70

2600.03.V RACCORDO DIRITTO RIDOTTO
REDUCED STRAIGHT FITTING



CODICE	Ø	◇	☐
260003V040300H	1/2"x3/8"	10	250
260003V050400H	3/4"x1/2"	10	150

2600.40.V TAPPO MASCHIO
MALE CAP



CODICE	Ø	◇	☐
260040V040000H	1/2"	10	300

2600.44.V RIDUZIONE ESAGONALE M/F
M/F HEXAGONAL BUSHING



CODICE	Ø	◇	☐
260044V040300H	1/2"x3/8"	10	300
260044V050400H	3/4"x1/2"	10	200

2600.D8.V PROLUNGA
EXTENSION



CODICE	Ø	◇	☐
2600D8V041000A	1/2"x10	10	200
2600D8V041500A	1/2"x15	10	150
2600D8V042500A	1/2"x25	10	150
2600D8V043000A	1/2"x30	10	100
2600D8V043500A	1/2"x35	10	100
2600D8V044000A	1/2"x40	10	100
2600D8V045000A	1/2"x50	10	80
2600D8V047000A	1/2"x70	5	40
2600D8V051000A	3/4"x10	10	150
2600D8V051500A	3/4"x15	10	150
2600D8V052000A	3/4"x20	10	100
2600D8V052500A	3/4"x25	10	80
2600D8V053000A	3/4"x30	10	80
2600D8V054000A	3/4"x40	10	60
2600D8V055000A	3/4"x50	10	50

2700.14.V RACCORDO A T FEMMINA
FEMALE TEE



CODICE	Ø	◇	📦
270014V040404A	1/2"	10	60
270014V101010A	1"	5	20

2700.F8.V ANGOLO M/F
M/F ELBOW



CODICE	Ø	◇	📦
2700F8V040400A	1/2"	10	100
2700F8V050500A	3/4"	10	50
2700F8V101000A	1"	5	30



SERIE/LINE 2600-2700
RACCORDI FILETTATI IN OTTONE
BRASS THREADED FITTINGS

RACCORDI PER TUBO
FERRO





SERIE 2100

LINE 2100



Raccordi di riparazione in ottone

Repairing fittings

I raccordi di riparazione della SERIE 2100 sono realizzati interamente in ottone CW617N di elevata qualità. Sono utilizzabili in impianti idrico-sanitari per adduzione di acqua calda e fredda, in impianti di riscaldamento ed in ogni tipo di installazione idraulica, domestica, commerciale, industriale, agricola e generalmente con qualsiasi tipologia di fluido non corrosivo.

Repairing fittings of LINE 2100 are made entirely of high quality CW617N brass.

They are suitable for hot and cold water in sanitary and heating installations and in any kind of sanitary installation such as domestic, commercial, industry and farming and with any type of non-corrosive fluid.

VANTAGGI







- Installazione rapida e sicura
- Lega di ottone CW617N conforme a EN 12165
- Materie prime impiegate di alta qualità [UBA LIST]

ADVANTAGES

- *Quick and safe installation*
- *CW617N brass complying with EN 12165 standard*
- *Raw materials complying with UBA LIST*

CAMPI DI APPLICAZIONI E PRESTAZIONI

FIELDS OF APPLICATION

APPLICAZIONI APPLICATIONS		T. min.	T. max	Press.max Max. pressure
 acqua potabile drinking water		-20°C	+100°C	10 bar
 acqua calda sanitaria hot sanitary water		-20°C	+100°C	10 bar
 raffrescamento cooling		-20°C	+100°C	10 bar
 radiatori (risc. alta temperatura) radiators		-20°C	+100°C	10 bar
 irrigazione irrigation		-20°C	+100°C	10 bar
 aria compressa compressed air		-20°C	+100°C	10 bar
	-20°C: solo con liquido antigelo glicole in % max del 30% -20°C: with the use of glycol in a maximum percentage of 30%			

NORMATIVE

- UNI EN 1254-4

I raccordi sono conformi alla norma UNI EN 1254-4: "Raccordi combinanti altri terminali di connessione con terminali di tipo capillare o a compressione."

- UNI EN ISO 228-1:2003

Tutte le filettature sono conformi alla norma UNI EN ISO 228-1:2003: "Filettatura di tubazioni per accoppiamento non a tenuta sul filetto".

- D.M. 174 (06/04/2004)

I materiali utilizzati sono conformi al Decreto Ministeriale n° 174 del 06/04/2004 [Regolamento concernente i materiali e gli oggetti che possono essere utilizzati negli impianti fissi di captazione, trattamento, adduzione e distribuzione delle acque destinate al consumo umano].

- Conforme a 4MS, UBA List (gruppo BC), DIN 50930/6 Dir. 2011/65/UE, 6C allegato III (RhOSII).

- UNI EN 10255:2007

Tubi di acciaio non legato adatti alla saldatura e alla filettatura - Condizioni tecniche di fornitura.

REGULATIONS

- UNI EN 1254-4

Fittings comply with UNI EN 1254-4 law: "Fittings combined with other coupling capillary or compression ends"

- UNI EN ISO 228-1:2003

Threads complies with UNI EN ISO 228-1:2003 law: "Piping thread for coupling not with tightness on the thread".

- D.M. 174 (06/04/2004)

Raw materials used are of high quality and comply with the Ministerial Decree N°174 dated 06/04/2004 concerning the materials and the items used in fixed installations for water collection, treatment and supply.

- Comply with 4MS, UBA List (BC group), DIN 50930/6 Dir. 2011/65/UE, 6C attachment III (RhOSII).

- UNI EN 10255:2007

Non-Alloy steel tubes suitable for welding and threading - Technical delivery conditions.

CERTIFICAZIONI CERTIFICATIONS

STATO COUNTRY	CERTIFICAZIONE CERTIFICATION	STATO COUNTRY	CERTIFICAZIONE CERTIFICATION	STATO COUNTRY	CERTIFICAZIONE CERTIFICATION
					
					
					

2100.00 RACCORDO DIRITTO DOPPIO
DOUBLE STRAIGHT FITTING



CODICE	Ø	◇	☐
210000H030300A	3/8"x3/8"	10	40
210000H040400A	1/2"x1/2"	10	30
210000H050500A	3/4"x3/4"	-	25
210000H101000A	1"x1"	-	15
210000H121200A	1"1/4x1"1/4	-	10
210000H141400A	1"1/2x1"1/2	-	8
210000H202000A	2"x2"	-	6

2100.02 RACCORDO DIRITTO FEMMINA
FEMALE STRAIGHT FITTING

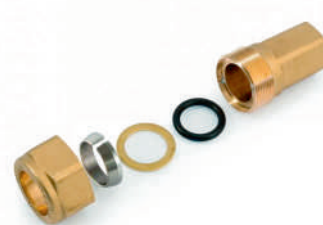

CODICE	Ø	◇	☐
210002H030300A	3/8"x3/8"	10	50
210002H040400A	1/2"x1/2"	10	40
210002H050500A	3/4"x3/4"	-	20
210002H101000A	1"x1"	-	20
210002H121200A	1"1/4x1"1/4	-	12
210002H141400A	1"1/2x1"1/2	-	8
210002H202000A	2"x2"	-	6

2100.01 RACCORDO DIRITTO MASCHIO
MALE STRAIGHT FITTING



CODICE	Ø	◇	☐
210001H030300A	3/8"x3/8"	10	50
210001H040400A	1/2"x1/2"	10	40
210001H050500A	3/4"x3/4"	-	30
210001H101000A	1"x1"	-	20
210001H121200A	1"1/4x1"1/4	-	12
210001H141400A	1"1/2x1"1/2	-	8
210001H202000A	2"x2"	-	6

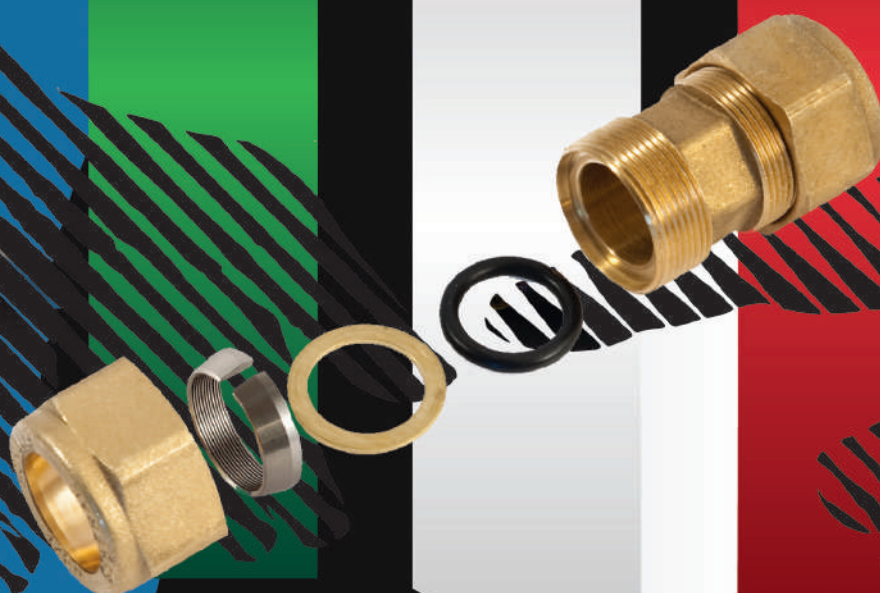

CLIO 

SERIE/LINE 2100
RACCORDI DI RIPARAZIONE
REPAIRING FITTINGS

SISTEMI PER
TUBO PE-X
PE-X PIPE
SYSTEMS

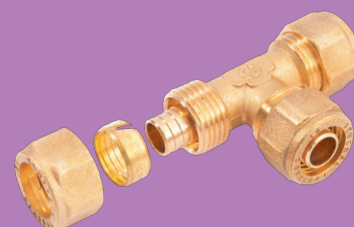



COMP_FIX

SERIE 3300

LINE 3300

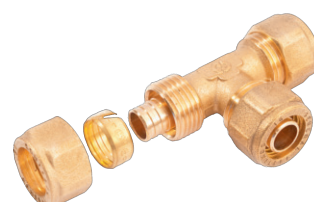

Raccordi a compressione con dado ed ogiva tagliata

Compression fittings with cut brass olive

I raccordi a compressione con dado ed ogiva tagliata per tubo PE-X sono utilizzabili per adduzione di acqua calda e fredda in impianti idrico-sanitari e di riscaldamento.

Possono essere inoltre utilizzati in ogni tipo di installazione idraulica, commerciale, domestica, industriale e agricola e in linea di massima con fluidi non aggressivi.

Compression fittings of LINE 3300 are suitable for the supply of hot and cold water in sanitary and heating installations.

They can be used for any kind of sanitary installation such as domestic, commercial, industry and farming, and with any type of non-corrosive fluid.









VANTAGGI

- Ampia gamma [dal Ø 12 al Ø 32]
- Versatilità: utilizzabili per acqua potabile e riscaldamento
- Semplicità e rapidità di installazione
- Materie prime impiegate di alta qualità [UBA LIST]

ADVANTAGES



- *Wide range [from Ø 12 to Ø 32]*
- *Suitable both for drinking water and for heating*
- *Quick and easy installation*
- *Raw materials complying with UBA LIST*

CAMPI DI APPLICAZIONI E PRESTAZIONI FIELDS OF APPLICATION

APPLICAZIONI APPLICATIONS	T. min.	T. max	T. di sistema T. of the system	Press.max Max. pressure
 acqua potabile drinking water	-20°C	+110°C	-20°C/+95°C	10 bar
 acqua calda sanitaria sanitary hot water	-20°C	+110°C	-20°C/+95°C	10 bar
 raffrescamento cooling	-20°C	+110°C	-20°C/+95°C	10 bar
 radiatori radiators	-20°C	+110°C	-20°C/+95°C	10 bar
 riscaldamento a pavimento floor heating	-20°C	+110°C	-20°C/+95°C	10 bar
 irrigazione irrigation	-20°C	+110°C	-20°C/+95°C	10 bar
 aria compressa compressed air	-20°C	+110°C	-20°C/+95°C	10 bar
	-20°C: solo con liquido antigelo glicole in % max del 30% -20°C: with the use of glycol in a maximum percentage of 30%			

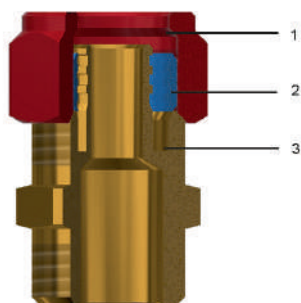
COMPONENTI E MATERIALI COMPONENTS AND MATERIALS



LEGENDA LEGEND	COMPONENTI COMPONENTS	MATERIALI MATERIALS
	1 Dado Nut	Ottone CW617N - UNI EN 12165 Brass CW617N - UNI EN 12165
	2 Ogiva Olive	Ottone CW617N - UNI EN 12164 Brass CW617N - UNI EN 12164
	3 Corpo Body	Ottone CW617N - UNI EN 12165 Brass CW617N - UNI EN 12165

TUBI COMPATIBILI

I raccordi della serie 3300 sono utilizzabili con tubi in polietilene reticolato PE-X.

SUITABLE PIPES

Fittings of line 3300 are suitable for installation with PEX pipes.

NORMATIVE

- UNI EN 1254-3
I raccordi sono conformi alla norma UNI EN 1254-3: "Raccorderia idraulica per tubazioni di plastica con terminali a compressione"
- UNI EN ISO 228-1:2003
Tutte le filettature sono conformi alla norma UNI EN ISO 228-1:2003: "Filettatura di tubazioni per accoppiamento non a tenuta sul filetto".
- D.M. 174 (06/04/2004)
I materiali utilizzati sono conformi al Decreto Ministeriale n° 174 del 06/04/2004 [Regolamento concernente i materiali e gli oggetti che possono essere utilizzati negli impianti fissi di captazione, trattamento, adduzione e distribuzione delle acque destinate al consumo umano].
- Conforme a 4MS, UBA List (gruppo BC), DIN 50930/6 Dir. 2011/65/UE, 6C allegato III (RhOSII)
- UNI EN ISO 15875-3:2007
Sistemi di tubazioni di materie plastiche per le installazioni di acqua calda e fredda - Polietilene reticolato (PE-X) - Parte 3: Raccordi.













REGULATIONS

- UNI EN 1254-3
Fittings comply with UNI EN 1254-3 law: "Sanitary fittings for plastic pipes with compression ends".
- UNI EN ISO 228-1:2003
Threads complies with UNI EN ISO 228-1:2003 law: "Piping thread for coupling not with tightness on the thread".
- D.M. 174 (06/04/2004)
Raw materials used are of high quality and comply with the Ministerial Decree N°174 dated 06/04/2004 concerning the materials and the items used in fixed installations for water collection, treatment and supply.
- Comply with 4MS, UBA List (BC group), DIN 50930/6 Dir. 2011/65/UE, 6C attachment III (RhOSII).
- UNI EN ISO 15875-3:2007
Plastics piping systems for hot and cold water installations - Crosslinked polyethylene (PE-X) - Part 3: Fittings

FILETTATURA E SERRAGGIO DADI THREADS AND NUTS TIGHTENING

Ø	Attacco filetto Thread coupling	N° Giri (+1/4) N° Turns (+1/4)
Ø 12	G 1/2"	3/4
Ø 15	G 1/2"	3/4
Ø 16	G 1/2"	3/4
Ø 18	M 24x1.5	3/4
Ø 20	G 3/4"	3/4
Ø 22	M 29x1.5	3/4
Ø 25	M 32x1.5	1/2
Ø 28	M 35x1.5	1/2
Ø 32	M 39x1.5	1/2

CERTIFICAZIONI CERTIFICATIONS

STATO COUNTRY	CERTIFICAZIONE CERTIFICATION	STATO COUNTRY	CERTIFICAZIONE CERTIFICATION	STATO COUNTRY	CERTIFICAZIONE CERTIFICATION
					
					

ISTRUZIONI DI MONTAGGIO ASSEMBLY INSTRUCTIONS

Utilizzando un apposito utensile taglia tubi [codice TT500.00] eseguire un taglio perpendicolare all'asse del tubo. Rimuovere eventuale bava residua.

Cut the pipe perpendicularly to its axis using an appropriate pipe cutting tool [code TT500.00]. Remove possible residual burr.



Inserire dado e ogiva sul tubo.

Insert nut and olive on the pipe.



Calzare il tubo sul portatubo del raccordo fino a battuta.

Insert the pipe into the pipe holder until the pipe stops.



Inserire il tubo a battuta e avvitare il dado per quanto consentito. Con chiave esagonale avvitare il dado fino a raggiungere il n° di giri indicato in tabella (pag. precedente).

Insert the pipe in the body until it stops. With an hexagonal wrench, tighten the nut until reaching the number of threads shown in the table (see previous page).



3300.00RACCORDO DIRITTO DOPPIO
DOUBLE STRAIGHT FITTING

CODICE	+	Ø	◇	☐
330000H122000A	2.0	12x12	10	100
330000H152500A	2.5	15x15	10	100
330000H162000A	2.0	16x16	10	100
330000H162200A	2.2	16x16	10	100
330000H182000A	2.0	18x18	10	80
330000H182500A	2.5	18x18	10	80
330000H202000A	2.0	20x20	10	60
330000H202800A	2.8	20x20	10	60
330000H223000A	3.0	22x22	5	50
330000H252300A	2.3	25x25	5	40
330000H253500A	3.5	25x25	5	40
330000H283000A	3.0	28x28	5	30
330000H323000A	2.9-3.0	32x32	-	25

3300.01RACCORDO DIRITTO MASCHIO
MALE STRAIGHT FITTING

CODICE	+	Ø	◇	☐
330001H031220A	2.0	3/8"x12	10	170
330001H031525A	2.5	3/8"x15	10	170
330001H041220A	2.0	1/2"x12	10	170
330001H041525A	2.5	1/2"x15	10	160
330001H041620A	2.0	1/2"x16	10	160
330001H041622A	2.2	1/2"x16	10	160
330001H041820A	2.0	1/2"x18	10	100
330001H041825A	2.5	1/2"x18	10	100
330001H042020A	2.0	1/2"x20	10	100
330001H042028A	2.8	1/2"x20	10	100
330001H042230A	3.0	1/2"x22	10	60
330001H051525A	2.5	3/4"x15	10	120
330001H051620A	2.0	3/4"x16	10	120
330001H051622A	2.2	3/4"x16	10	120
330001H051820A	2.0	3/4"x18	10	100
330001H051825A	2.5	3/4"x18	10	100
330001H052020A	2.0	3/4"x20	10	80
330001H052028A	2.8	3/4"x20	10	80
330001H052230A	3.0	3/4"x22	10	60
330001H052523A	2.3	3/4"x25	10	50
330001H052535A	3.5	3/4"x25	10	50
330001H052830A	3.0	3/4"x28	5	40
330001H053230A	2.9-3.0	3/4"x32	5	40
330001H102523A	2.3	1"x25	5	40
330001H102535A	3.5	1"x25	5	40
330001H102830A	3.0	1"x28	5	40
330001H103230A	2.9-3.0	1"x32	-	40

3300.02**RACCORDO DIRITTO FEMMINA
FEMALE STRAIGHT FITTING**

CODICE	+	Ø	◇	◻
330002H031220A	2.0	3/8"x12	10	150
330002H031525A	2.5	3/8"x15	10	150
330002H041220A	2.0	1/2"x12	10	150
330002H041525A	2.5	1/2"x15	10	150
330002H041620A	2.0	1/2"x16	10	150
330002H041622A	2.2	1/2"x16	10	150
330002H041820A	2.0	1/2"x18	10	100
330002H041825A	2.5	1/2"x18	10	100
330002H042020A	2.0	1/2"x20	10	80
330002H042028A	2.8	1/2"x20	10	80
330002H042230A	3.0	1/2"x22	10	60
330002H051525A	2.5	3/4"x15	10	100
330002H051620A	2.0	3/4"x16	10	100
330002H051622A	2.2	3/4"x16	10	100
330002H051820A	2.0	3/4"x18	10	80
330002H051825A	2.5	3/4"x18	10	80
330002H052020A	2.0	3/4"x20	10	80
330002H052028A	2.8	3/4"x20	10	80
330002H052230A	3.0	3/4"x22	10	70
330002H052523A	2.3	3/4"x25	10	50
330002H052535A	3.5	3/4"x25	5	50
330002H052830A	3.0	3/4"x28	5	40
330002H102523A	2.3	1"x25	5	40
330002H102535A	3.5	1"x25	5	40
330002H102830A	3.0	1"x28	5	40
330002H103230A	2.9-3.0	1"x32	-	40

3300.10**RACCORDO A T
TEE**

CODICE	+	Ø	◇	◻
330010H122000A	2.0	12x12x12	10	60
330010H152500A	2.5	15x15x15	10	60
330010H162000A	2.0	16x16x16	10	60
330010H162200A	2.2	16x16x16	10	60
330010H182000A	2.0	18x18x18	10	40
330010H182500A	2.5	18x18x18	10	40
330010H202000A	2.0	20x20x20	10	30
330010H223000A	3.0	22x22x22	5	20
330010H252300A	2.3	25x25x25	5	20
330010H283000A	3.0	28x28x28	-	10
330010H323000A	2.9-3.0	32x32x32	-	10

3300.11RACCORDO A T MASCHIO
MALE TEE

CODICE	+	Ø	◇	☐
330011H041220A	2.0	12x1/2"x12	10	60
330011H041525A	2.5	15x1/2"x15	10	60
330011H041620A	2.0	16x1/2"x16	10	60
330011H041622A	2.2	16x1/2"x16	10	60
330011H041820A	2.0	18x1/2"x18	10	40
330011H041825A	2.5	18x1/2"x18	10	40
330011H042230A	3.0	22x1/2"x22	10	30
330011H052020A	2.0	20x3/4"x20	10	30
330011H052028A	2.8	20x3/4"x20	10	30
330011H052230A	3.0	22x3/4"x22	5	30
330011H052535A	3.5	25x3/4"x25	5	20
330011H102830A	3.0	28x1"x28	5	10
330011H103230A	2.9-3.0	32x1"x32	-	10

3300.12RACCORDO A T FEMMINA
FEMALE TEE

CODICE	+	Ø	◇	☐
330012H041220A	2.0	12x1/2"x12	10	50
330012H041525A	2.5	15x1/2"x15	10	50
330012H041620A	2.0	16x1/2"x16	10	50
330012H041622A	2.2	16x1/2"x16	10	50
330012H041820A	2.0	18x1/2"x18	10	40
330012H041825A	2.5	18x1/2"x18	10	40
330012H042020A	2.0	20x1/2"x20	10	30
330012H042230A	3.0	22x1/2"x22	10	30
330012H051820A	2.0	18x3/4"x18	10	30
330012H051825A	2.5	18x3/4"x18	10	30
330012H052020A	2.0	20x3/4"x20	10	30
330012H052230A	3.0	22x3/4"x22	5	30
330012H052523A	2.3	25x3/4"x25	5	20
330012H052535A	3.5	25x3/4"x25	5	20
330012H052830A	3.0	28x3/4"x28	5	15
330012H102523A	2.3	25x1"x25	5	20
330012H102535A	3.5	25x1"x25	5	20
330012H102830A	3.0	28x1"x28	5	20
330012H103230A	2.9-3.0	32x1"x32	-	15

3300.13RACCORDO A T RIDOTTO
REDUCED TEE

CODICE	+	Ø	◇
330013H726666A	2.3/2.0/2.0	25x20x20	5

3300.20ANGOLO DOPPIO
DOUBLE ELBOW

CODICE	+	Ø	◇	□
330020H122000A	2.0	12x12	10	80
330020H152500A	2.5	15x15	10	80
330020H162000A	2.0	16x16	10	80
330020H162200A	2.2	16x16	10	80
330020H182000A	2.0	18x18	10	60
330020H182500A	2.5	18x18	10	60
330020H202000A	2.0	20x20	10	50
330020H202800A	2.8	20x20	10	50
330020H223000A	3.0	22x22	10	40
330020H252300A	2.3	25x25	5	20
330020H283000A	3.0	28x28	5	20
330020H323000A	2.9-3.0	32x32	-	20

3300.21ANGOLO MASCHIO
MALE ELBOW

CODICE	+	Ø	◇	□
330021H041220A	2.0	1/2"x12	10	100
330021H041525A	2.5	1/2"x15	10	100
330021H041620A	2.0	1/2"x16	10	100
330021H041622A	2.2	1/2"x16	10	100
330021H041820A	2.0	1/2"x18	10	80
330021H041825A	2.5	1/2"x18	10	80
330021H042020A	2.0	1/2"x20	10	60
330021H042230A	3.0	1/2"x22	10	50
330021H051525A	2.5	3/4"x15	10	70
330021H051620A	2.0	3/4"x16	10	70
330021H051622A	2.2	3/4"x16	10	70
330021H051825A	2.5	3/4"x18	10	70
330021H052020A	2.0	3/4"x20	10	50
330021H052230A	3.0	3/4"x22	10	50
330021H052523A	2.3	3/4"x25	5	30
330021H052535A	3.5	3/4"x25	5	30
330021H053230A	2.9-3.0	3/4"x32	5	20
330021H102523A	2.3	1"x25	5	30
330021H102535A	3.5	1"x25	5	30
330021H102830A	3.0	1"x28	5	30
330021H103230A	2.9-3.0	1"x32	-	20

3300.22

ANGOLO FEMMINA
FEMALE ELBOW



CODICE	+	Ø	◇	☐
330022H041220A	2.0	1/2"x12	10	80
330022H041525A	2.5	1/2"x15	10	80
330022H041620A	2.0	1/2"x16	10	80
330022H041622A	2.2	1/2"x16	10	80
330022H041820A	2.0	1/2"x18	10	70
330022H041825A	2.5	1/2"x18	10	70
330022H042020A	2.0	1/2"x20	10	60
330022H042028A	2.8	1/2"x20	10	60
330022H042230A	3.0	1/2"x22	10	40
330022H051525A	2.5	3/4"x15	10	40
330022H051620A	2.0	3/4"x16	10	40
330022H051622A	2.2	3/4"x16	10	40
330022H051825A	2.5	3/4"x18	10	40
330022H052020A	2.0	3/4"x20	10	40
330022H052028A	2.8	3/4"x20	10	40
330022H052230A	3.0	3/4"x22	10	40
330022H052523A	2.3	3/4"x25	5	30
330022H052535A	3.5	3/4"x25	5	30
330022H102523A	2.3	1"x25	5	30
330022H102535A	3.5	1"x25	5	30
330022H102830A	3.0	1"x28	5	20
330022H103230A	2.9-3.0	1"x32	-	20

3300.23

ATTACCO A MURO CON FLANGIA 3 FORI
WALLPLATE ELBOW WITH 3 HOLES



CODICE	+	Ø	◇	☐
330023H041525A	2.5	1/2"x15	10	50
330023H041620A	2.0	1/2"x16	10	50
330023H041622A	2.2	1/2"x16	10	50
330023H041820A	2.0	1/2"x18	10	50
330023H041825A	2.5	1/2"x18	10	50
330023H042020A	2.0	1/2"x20	10	40
330023H042028A	2.8	1/2"x20	10	40

**3300.R6
ROSSO**

COLLETTORE FASATO CON MINI VALVOLE E USCITE
A COMPRESSIONE PER TUBO PE-X
MANIFOLD WITH MINI-VALVES WITH COMPRESSION
EXITS FOR PE-X PIPE



CODICE	+	□	⋈	∅	☐
3300R6H0552R2A	2.5	3/4"	2	15	20
3300R6H0552R3A	2.5	3/4"	3	15	15
3300R6H0552R4A	2.5	3/4"	4	15	10
3300R6H0556R2A	2.0	3/4"	2	16	20
3300R6H0556R3A	2.0	3/4"	3	16	15
3300R6H0556R4A	2.0	3/4"	4	16	10
3300R6H0558R3A	2.2	3/4"	3	16	15
3300R6H0558R2A	2.2	3/4"	2	16	20
3300R6H0558R4A	2.2	3/4"	4	16	10
3300R6H1058R2A	2.2	1"	2	16	20
3300R6H1058R3A	2.2	1"	3	16	15

3300.R6 BLU

COLLETTORE FASATO CON MINI VALVOLE E USCITE
A COMPRESSIONE PER TUBO PE-X
MANIFOLD WITH MINI-VALVES WITH COMPRESSION
EXITS FOR PE-X PIPE



CODICE	+	□	⋈	∅	☐
3300R6H0552B2A	2.5	3/4"	2	15	20
3300R6H0552B3A	2.5	3/4"	3	15	15
3300R6H0552B4A	2.5	3/4"	4	15	10
3300R6H0556B2A	2.0	3/4"	2	16	20
3300R6H0556B3A	2.0	3/4"	3	16	15
3300R6H0556B4A	2.0	3/4"	4	16	10
3300R6H0558B2A	2.2	3/4"	2	16	20
3300R6H0558B3A	2.2	3/4"	3	16	15
3300R6H0558B4A	2.2	3/4"	4	16	10
3300R6H1058B2A	2.2	1"	2	16	20
3300R6H1058B3A	2.2	1"	3	16	15

MA00.80

LEVETTA COLLETTORE
MANIFOLD HANDLE



CODICE	i
MA0080B183300A	BLU
MA0080R183300A	ROSSO

3300.61COLLETTORE M/F
M/F MANIFOLD

CODICE	+	+	+	Ø	☐
330061H055002A	2.0	2	12	3/4"x12	40
330061H055003A	2.0	3	12	3/4"x12	24
330061H055004A	2.0	4	12	3/4"x12	20
330061H055202A	2.5	2	15	3/4"x15	40
330061H055203A	2.5	3	15	3/4"x15	24
330061H055204A	2.5	4	15	3/4"x15	20
330061H055602A	2.0	2	16	3/4"x16	40
330061H055603A	2.0	3	16	3/4"x16	24
330061H055604A	2.0	4	16	3/4"x16	20
330061H055802A	2.2	2	16	3/4"x16	40
330061H055803A	2.2	3	16	3/4"x16	24
330061H055804A	2.2	4	16	3/4"x16	20
330061H105602A	2.0	2	16	1"x16	25
330061H105603A	2.0	3	16	1"x16	20
330061H105604A	2.0	4	16	1"x16	14
330061H105802A	2.2	2	16	1"x16	25
330061H105803A	2.2	3	16	1"x16	20
330061H105804A	2.2	4	16	1"x16	14

3300.70DADO
NUT

CODICE	Ø
110070H041200A	12
110070H041500A	15
110070H041600A	16
110070H241800A	18
330070H200000A	20
330070H220000A	22
330070H250000A	25
330070H280000A	28
330070H320000A	32

3300.81OGIVA TAGLIATA
CUT OLIVE

CODICE	Ø	
330081R120000A	12	-
330081R150000A	15	-
330081R160000A	16	2000
330081R180000A	18	-
330081R200000A	20	-
330081R220000A	22	-
330081R250000A	25	500
330081R280000A	28	-
330081R320000A	32	-

3300.H9ANGOLO 105°
105° ELBOW

CODICE		i	Ø		
3300H9H041525A	2.5	-	1/2"x15	10	70
3300H9H041620A	2.0	-	1/2"x16	10	70
3300H9H041622A	2.2	-	1/2"x16	10	70
3300H9HK41525A	2.5	Compatta	1/2"x15	10	70
3300H9HK41620A	2.0	Compatta	1/2"x16	10	70

3300.27ANGOLO 100°
100° ELBOW

CODICE		Ø		
330027H041220A	2.0	1/2"x12	10	70
330027H041620A	2.0	1/2"x16	10	70
330027H041622A	2.2	1/2"x16	10	70

3300.28ANGOLO 100° CON PROLUNGA
100° ELBOW WITH EXTENSION

CODICE		Ø		
330028H041620A	2.0	1/2"x16	-	50
330028H041820A	2.0	1/2"x18	10	50
330028H041825A	2.5	1/2"x18	10	50
330028H042020A	2.0	1/2"x20	10	50
330028H042028A	2.8	1/2"x20	10	50

AC00.70

CURVA REGGITUBO IN PLASTICA
PLASTIC BEND FOR PIPE



CODICE	Ø	◇	☐
AC0070H160000H	15-16	20	40
AC0070H200000H	20-22	15	15
AC0070H250000H	25	10	10

La curva reggitubo è utilizzata per la curvatura a freddo delle tubazioni. Serve inoltre a sostenere i tubi e a proteggerli da eventuali urti.

The pipe holder bend is used for cold bending of pipes. It is also used to support the pipes and protect them from possible impacts.

AC00.80 PE-X CURVA REGGITUBO PER TUBO PE-X
BEND FOR PE-X PIPE

CODICE	Ø	◇	☐
AC0080H160000H	15-16	60	120
AC0080H180000H	18	40	40
AC0080H200000H	20-22	25	25
AC0080H250000H	25	10	20

La curva reggitubo è utilizzata per la curvatura a freddo delle tubazioni. Serve inoltre a sostenere i tubi e a proteggerli da eventuali urti.

The pipe holder bend is used for cold bending of pipes. It is also used to support the pipes and protect them from possible impacts.

AC00.90
ROSSA

SCATOLA PER ANGOLO
BOX FOR ELBOW

AC00.90
NERA









SCATOLA PER ANGOLO
BOX FOR ELBOW



CODICE	Ø	
AC0090H201000H	unica	400

CODICE	Ø	
AC0090H161001H	unica	250

Fino ad esaurimento scorte / Until stocks are exhausted.

ARTICOLO/ARTICLE	COMPATIBILITA'/COMPATIBILITY	DESCRIZIONE/DESCRIPTION	IMMAGINE/IMAGE
AC0090H201000H Rosso / Red 	3300H9HK41620A	Angolo/Elbow 105° 1/2"x16x2.0 Compact	
	330027H041220A	Angolo/Elbow 100° 1/2"x12x2.0	
	330027H041620A	Angolo/Elbow 100° 1/2"x16x2.0	
	330027H041622A	Angolo/Elbow 100° 1/2"x16x2.2	
	330028H041620A	Angolo/Elbow 100° 1/2"x16x2.3	
	330028H041820A	Angolo/Elbow 100° 1/2"x18x2.0	
	330028H041825A	Angolo/Elbow 100° 1/2"x18x2.5	
	330028H042020A	Angolo/Elbow 100° 1/2"x20x2.0	
	330028H042028A	Angolo/Elbow 100° 1/2"x20x2.8	
AC0090H161001H Nero / Black 	3300H9HK41620A	Angolo/Elbow 105° 1/2"x16x2.0 Compact	
	3300H9HK41525A	Angolo/Elbow 105° 1/2"x15x2.5 Compact	
	330027H041220A	Angolo/Elbow 100° 1/2"x12x2.0	
	330027H041620A	Angolo/Elbow 100° 1/2"x16x2.0	
	330027H041622A	Angolo/Elbow 100° 1/2"x16x2.2	
	330028H041620A	Angolo/Elbow 100° 1/2"x16x2.3	
	330028H041820A	Angolo/Elbow 100° 1/2"x18x2.0	
	330028H041825A	Angolo/Elbow 100° 1/2"x18x2.5	
	330028H042020A	Angolo/Elbow 100° 1/2"x20x2.0	
330028H042028A	Angolo/Elbow 100° 1/2"x20x2.8		



Gold-Fix

SERIE 3400

LINE 3400



Raccordi a pressatura assiale per tubo PE-X e multistrato

Axial press fittings for Pe-X and Multilayer pipes

I raccordi a pressatura assiale della serie 3400 GOLDFIX sono utilizzabili per adduzione di acqua calda e fredda in impianti idrico-sanitari, impianti di riscaldamento a radiatori e a pannelli radianti, sistemi di raffreddamento a pannelli radianti, impianti per aria compressa, impianti per il trasporto di sostanze chimiche o derivati da petrolio (previa verifica dell'ufficio tecnico di General Fittings).

3400 GOLDFIX fittings are suitable for the supply of hot and cold sanitary water, heating systems with radiators and radiant panels, compressed air installations, systems for the transportation of chemical substances or crude oil derived one (upon General Fittings technical department check).









VANTAGGI

- Completezza della gamma
- Un unico sistema per acqua potabile e riscaldamento
- Installazione efficiente: possibilità di realizzare impianti in serie e ad anello con l'attacco a muro doppio per garantire una migliore distribuzione e ricambio dell'acqua
- Installazione semplice e rapida anche con attrezzature manuali
- Installazione sicura: collegamento a tenuta stagna, senza punti di ristagno e senza richiedere O-ring o ulteriori guarnizioni
- Maggiore passaggio di acqua e di conseguenza minori perdite di carico
- Utilizzabile per tubi PEX e multistrato
- Trattamento termico della bussola che garantisce maggiore plasticità, maggiore capacità di deformazione e minore possibilità di rottura in esercizio
- Grande affidabilità nel tempo
- Materie prime impiegate di alta qualità [UBA LIST]

ADVANTAGES



- Complete range
- One system both for drinking water and heating installations
- Efficient installation: double wallplate elbow allows to make installations in series or rings for a better distribution and change of water
- Quick and easy installation also with manual tools
- Safe installation: watertight connection, without stagnation points and without requiring O-rings or additional gaskets
- Greater water flow and consequently lower pressure drops
- Suitable both for PEX and multilayer (Pex/Al/Pex) pipes
- Heat treatment of the bush which guarantees greater plasticity, greater deformation capacity and less chance of breakage
- Great reliability over time
- Raw materials complying with UBA LIST

CAMPI DI APPLICAZIONI E PRESTAZIONI FIELDS OF APPLICATION

APPLICAZIONI APPLICATIONS	T. min.	T. max	T. di sistema T. of the system	Press.max Max. pressure
 acqua potabile drinking water	-20°C	+120°C	-20°C/+95°C	10 bar
 acqua calda sanitaria sanitary hot water	-20°C	+120°C	-20°C/+95°C	10 bar
 raffrescamento cooling	-20°C	+120°C	-20°C/+95°C	10 bar
 radiatori radiators	-20°C	+120°C	-20°C/+95°C	10 bar
 riscaldamento a pavimento floor heating	-20°C	+120°C	-20°C/+95°C	10 bar
 irrigazione irrigation	-20°C	+120°C	-20°C/+95°C	10 bar
 aria compressa compressed air	-20°C	+120°C	-20°C/+95°C	10 bar
 -20°C: solo con liquido antigelo glicole in % max del 30% -20°C: with the use of glycol in a maximum percentage of 30%				

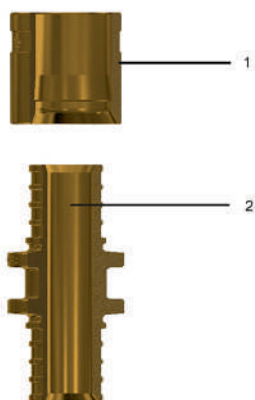
COMPONENTI E MATERIALI COMPONENTS AND MATERIALS



LEGENDA LEGEND	COMPONENTI COMPONENTS	MATERIALI MATERIALS
 1	Bussola Sleeve	Ottone CW612N - UNI EN 12164 Brass CW612N - UNI EN 12164
 2	Corpo Body	Ottone CW617N/CW612N - UNI EN 12165 Brass CW617N/CW612N - UNI EN 12165

TUBI COMPATIBILI

I raccordi della serie 3400 GOLDFIX sono utilizzabili con tubi in polietilene reticolato PE-Xa e con tubi multistrato con anima in alluminio.

Per la lista completa e le caratteristiche delle tubazioni fare riferimento al catalogo ufficiale o visitare il sito www.generalfittings.it

SUITABLE PIPES

Fittings of line 3400 GOLDFIX are suitable for installation both with PEX pipes and multilayer (Pex/Al/Pex) pipes. For the complete list of available pipes refer to the catalogue or visit the website www.generalfittings.it

NORMATIVE

- UNI 21003-3
I raccordi sono conformi alla norma ISO 21003-3: "Sistemi di tubazioni multistrato per le installazioni di acqua calda e fredda all'interno degli edifici."

- UNI EN ISO 15875-3
I raccordi sono conformi alla norma UNI EN ISO 15875-3: "Sistemi di tubazioni di materie plastiche per le installazioni di acqua calda e fredda".

- UNI EN 1254-3
I raccordi sono conformi alla norma UNI EN 1254-3: "Raccorderia idraulica per tubazioni di plastica con terminali a compressione".

- UNI EN 12226-1
Tutte le filettature sono conformi alla norma UNI EN 12226-1: "Filettatura di tubazioni per accoppiamento con tenuta sul filetto".

- D.M. 174 (06/04/2004)
I materiali utilizzati sono conformi al Decreto Ministeriale n° 174 del 06/04/2004 [Regolamento concernente i materiali e gli oggetti che possono essere utilizzati negli impianti fissi di captazione, trattamento, adduzione e distribuzione delle acque desti

- Conforme a 4MS, UBA List (gruppo BC), DIN 50930/6 Dir. 2011/65/UE, 6C allegato III (RhOSII)

REGULATIONS

- UNI 21003-3
"Multilayer piping systems for hot and cold water supply installations inside building"

- UNI EN ISO 15875-3
Fittings comply with UNI EN ISO 15875-3 law: "Plastic piping systems for hot and cold water installations - Crosslinked polyethylene (PE-X) - Part 3: Fittings".

- UNI EN 1254-3
Fittings comply with UNI EN 1254-3 law: "Sanitary fittings for plastic pipes with compression ends".

- UNI EN 12226-1
Threads comply with UNI EN 10226-1 law: "Piping thread for coupling on the thread".

- D.M. 174 (06/04/2004)
Raw materials used are of high quality and comply with the Ministerial Decree N°174 dated 06/04/2004 concerning the materials and the items used in fixed installations for water collection, treatment and supply.

- Comply with 4MS, UBA List (BC group), DIN 50930/6 Dir. 2011/65/UE, 6C attachment III (RhOSII).

DIAMETRO TUBO - SVASATORI E GANASCE PIPE DIAMETERS - REAMERS AND JAWS

Pe-X		
Ø tubo Ø pipe	Svasatore Reamer	Ganascia Jaw
16 x 2.2	RH-HIS	RE 16
20 x 2.8	RH-HIS	RE 20
25 x 3.5	RH-HIS	RE 25
32 x 4.4	RH-HIS	RE 32

Multistrato Multilayer Pe-X/Al/Pex		
Ø tubo Ø pipe	Svasatore Reamer	Ganascia Jaw
16.2 x 2.6	RH-MKV	RE 16
20 x 2.9	RH-MKV	RE 20
25 x 3.7	RH-MKV	RE 25
32 x 4.7	RH-MKV	RE 32

CERTIFICAZIONI CERTIFICATIONS

STATO COUNTRY	CERTIFICAZIONE CERTIFICATION	STATO COUNTRY	CERTIFICAZIONE CERTIFICATION	STATO COUNTRY	CERTIFICAZIONE CERTIFICATION
					
					
					

AVVERTENZE

Le seguenti istruzioni sono da applicare a sistemi definiti per raccordi GOLDFIX e tubo PE-Xa (dimensioni 16-20-25-32) con barriera ossigeno o sistemi con tubo multistrato PE-X/Al/PE-X (dimensioni 16-20-25-32). Utilizzare sempre macchine e attrezzature definite nel catalogo generale General Fittings.

Il senso della bussola NON è reversibile. La marcatura della bussola deve essere sempre opposta alla direzione di inserimento del tubo.

Il tubo General Fittings PE-Xa è dotato di barriera intrusione ossigeno. La barriera anti-ossigeno non è però flessibile come il tubo in polietilene e potrebbe lacerarsi nella fase di espansione del tubo, soprattutto alle basse temperature. Questo però non influisce sulla sicurezza e garanzia di tenuta.

Qualora la fase di espansione venga eseguita troppo velocemente e a temperature sotto lo zero, anche lo strato del tubo PE-Xa, oltre la barriera ossigeno, potrebbe danneggiarsi e lacerarsi. In questo caso deve essere necessariamente asportata la parte di tubo che risulta danneggiata e ripetere l'operazione.

Macchina manuale e macchina ad azionamento elettrico: la macchina manuale è applicabile a sistemi PE-Xa nelle dimensioni 16-20-25-32 e sistemi PE-Xc/Al/PE-Xc nelle dimensioni 16-20.

La macchina ad azionamento elettrico è applicabile a sistemi PE-Xa nelle dimensioni 16-20-25-32 e sistemi PE-Xc/Al/PE-Xc nelle dimensioni 16-20-25-32.

Proteggere raccordi e manicotti prima del contatto con la

INSTRUCTIONS

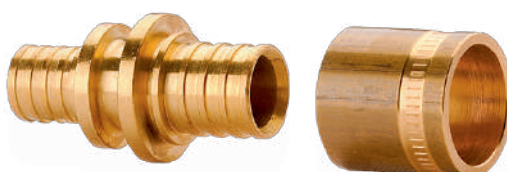

The following instructions have to be applied to systems defined for GOLD-FIX fittings and PE-Xa pipe with oxygen barrier (dimensions 16-20-25-32) or PE-X/Al/PE-X multilayer systems (dimensions 16-20-25-32).

Always use machines and equipments defined in General Fittings catalogue.

The direction of the sleeve is NOT reversible. The marking of the sleeve must always be opposite to the direction of pipe insertion.

General Fittings PE-Xa pipe is equipped with an oxygen barrier. The oxygen barrier is not flexible like the polyethylene pipe and could tear in the expansion phase of the pipe, especially at low temperatures. However, this does not affect safety and guarantee of the tightness.

If the expansion phase is made too quickly and at temperatures below 0°C, even the layer of PE-Xa pipe can be damaged, beside the oxygen barrier. In this case the damaged part of the pipe must be removed and repeated the operation.

General Fittings Multilayer PE-Xc / Al / PE-Xc pipe is equipped with a guaranteed oxygen intrusion barrier from the internal aluminum layer. If the expansion phase is carried out too quickly and at temperatures below zero, the layer of the PE-Xc pipe and aluminum could be damaged and lacerated. In this case the damaged part of the pipe must be removed and repeated the operation.

Manual machine and electrically operated machine: the manual machine is suitable for systems with PE-Xa pipe in sizes 16-20-25-32 and PE-Xc / Al / PE-Xc pipes in sizes

muratura da fluidi e altre sostanze aggressive attraverso un adeguato rivestimento.

Per indicazioni tecniche di prodotto rivolgersi direttamente all'Ufficio Tecnico di General Fittings Spa.

16-20. The electrically operated machine it is suitable for PE-Xa pipes in sizes 16-20-25-32 and PE-Xc / Al / PE-Xc pipes in sizes 16-20-25-32.

Fittings and sleeves must be protected before putting in contact with masonry from fluids and other aggressive substances by a suitable coating.

For any technical product information please contact directly the Technical Department of General Fittings Spa.

ISTRUZIONI DI MONTAGGIO ASSEMBLY INSTRUCTIONS

Prima di eseguire il taglio del tubo verificare che il tubo non presenti difetti superficiali e che la marcatura sia leggibile e completa in ogni sua parte

Before cutting the pipe, check that the pipe has no surface defects and that the marking is readable and complete in all its parts



Verificare sempre che la lama della cesoia sia perfettamente affilata e tagliente, priva di ammaccature o parti danneggiate

Always check that the shear blade is perfectly sharp, without dents or damaged parts



Utilizzando un apposito utensile taglia tubi [codice TT50.00] eseguire un taglio perpendicolare all'asse del tubo.

Cut the pipe perpendicularly to its axis using an appropriate pipe-cutting tool [code TT500.00].

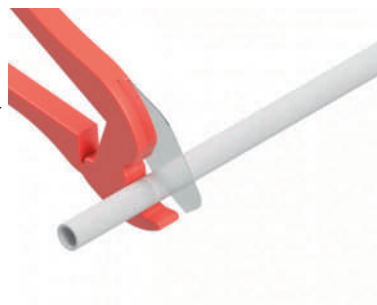

Il taglio deve essere sempre effettuato sulla parte dritta del tubo a una distanza minima di 150mm dal raccordo precedente o a una distanza minima di 20mm dalla fine del raggio di piegatura del tubo.

Il taglio deve essere netto, senza sbavature interne od esterne al tubo.

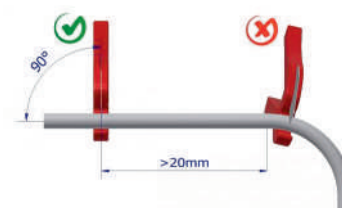

The cut must always be made on the straight part of the pipe at a minimum distance of 150mm from the closest fitting or at a minimum distance of 20mm from the pipe's bend ending.

The cut must be clean, without pipe internal or external burrs.

Verificare che l'espansore non sia danneggiato e che si avviti fino a battuta. Una volta avvitato l'espansore non deve svitarsi durante la rotazione del tubo sull'espansore. Verificare che l'attrezzo utilizzato sia corretto e definito per il tubo che stiamo per assemblare. Inserire l'espansore senza forzature e parallelo all'asse del tubo.



Check that the expander is not damaged and it is screwed up to the end. Once screwed the expander shouldn't unscrew during the rotation of the pipe on the expander. Verify that the tool we are going to use is correct and studied for the pipe we are going to assemble. Insert the expander without forcing and parallel to the axis of the pipe.

Inserire la bussola sul tubo, verificando che la marcatura sia opposta al taglio del tubo e che tra la fine del tubo e la bussola ci sia una distanza doppia rispetto alla bussola.

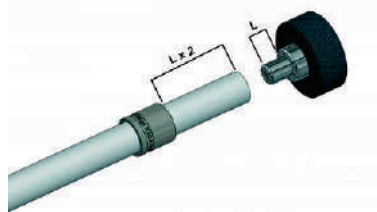

Insert the sleeve into the pipe, making sure that the marked strip is opposite to the cut of the pipe and that there is double distance compared to the sleeve between the end of the pipe and the sleeve itself.

Allargare in maniera graduale e omogenea il tubo senza scaldare le parti in deformazione. Le temperature consigliate nella fase di svasatura a freddo possono andare da -10°C a 50°C .

NB: in funzione della tipologia di tubo, utilizzare l'idoneo svasatore.

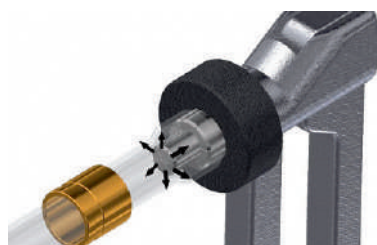

Gradually and homogeneously widen the pipe without heating the deforming parts. Temperatures recommended during this flaring phase go from -10°C to $+50^{\circ}\text{C}$.

NB: according to the different pipes, use the appropriate reamer.

L'operazione di espansione deve essere ripetuta almeno una seconda volta ruotando l'attrezzatura di 30° . Se la parte interna del tubo non risulta perfettamente cilindrica, ripetere ancora le operazioni descritte.

The expansion operation must be repeated at least a second time by turning the equipment by 30° . If the internal part of the pipe is not perfectly cylindrical, repeat the described operations again.



Tagliare i tubi che non presentano una circolarità regolare dopo l'espansione e scartare lo spezzone di tubo non conforme. Sostituire gli espansori che risultano danneggiati o non permettono la perfetta circolarità del tubo allargato. L'espansore difettoso può provocare problemi di tenuta nel tempo.

Ingrassare il cono dell'espansore qualora l'azionamento della macchina risulti difficoltoso.

Qualora si presentassero, dopo l'espansione, delle fessurazioni o delle crepe del tubo, eliminare il tubo danneggiato e ripetere l'operazione di espansione.

Cut pipes which are not circular adjust after expansion and waste the piece of non-conformed pipe. Replace expanders which are damaged or do not allow perfect circularity of the enlarged pipe. The defective expander can cause sealing problems over time.

Grease the expander cone if the actuation of the tool is difficult. If, after the expansion, there are cracks or slots on the pipe, remove the damaged tube and repeat the expansion operation.



Se tutte le procedure per l'espansione del tubo sono state rispettate, il tubo si infilerà sul raccordo senza forzature, se eventualmente ci fosse difficoltà nell'inserimento del tubo, ripetere le operazioni di espansione.

If all recommended procedures for the expansion of the pipe have been adopted, the pipe will slide onto the fitting without forcing. If the insertion of the pipe is difficult, repeat the above mentioned expansion operations.



Il tubo ha un effetto di ritorno naturale (effetto memory). Le operazioni di assemblaggio tubo e raccordo devono essere quindi effettuate in tempi brevi. Tutte le nervature di tenuta del raccordo devono essere avvolte dal tubo inserito manualmente.

The pipe has a natural return effect (memory effect). Pipe and fitting assembly operations must therefore be carried out quickly. All sealing ribs of the fitting must be covered by the pipe inserted manually.



MANUALE: Spingere la bussola verso il raccordo. Posizionare gli elementi nelle ganasce della macchina pressatrice, prestando attenzione che la bussola e il collarino del raccordo siano correttamente alloggiati in battuta alla ganascia.

MANUAL: Push the sleeve towards the fitting. Put the elements in the jaws of the pressing machine, making sure that the sleeve and the fitting collar are inserted properly.

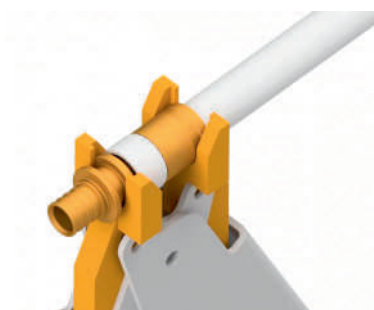

AUTOMATICA: Spingere la bussola verso il raccordo. Posizionare gli elementi nelle ganasce della macchina pressatrice, prestando attenzione che la bussola e il collarino del raccordo siano correttamente alloggiati in battuta alla ganascia.

AUTOMATIC: Push the sleeve towards the fitting. Put the elements in the jaws of the pressing machine, making sure that sleeve and fitting collar are inserted properly.

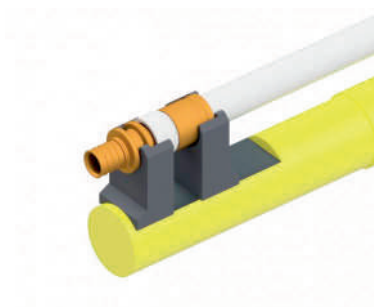

Azionare la pressatrice.

Start the pressing machine.

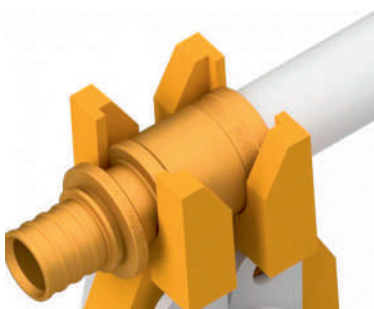

Verificare che la bussola montata sia in battuta con il corpo del raccordo.

Make sure that the assembled sleeve is up the stroke of the fitting's body.

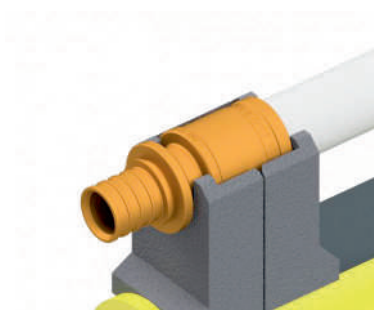

Posizionare sempre il tubo e la bussola in battuta.

Put pipe and sleeve in abutment.

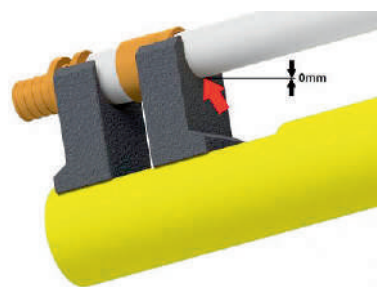

Verificare che la bussola e il raccordo siano sempre inserite nella corretta posizione.

Check that sleeve and fitting are always inserted in the correct position.

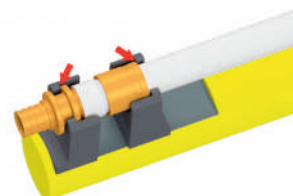

Il posizionamento perpendicolare permette un montaggio coassiale della bussola.

The perpendicular positioning allows a coaxial assembly of the sleeve.

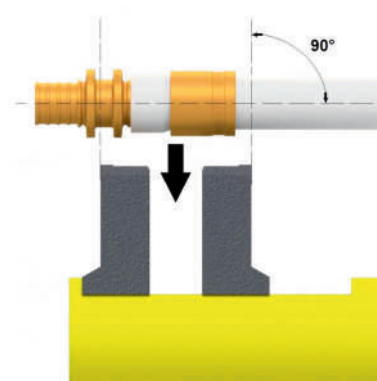

3400.00RACCORDO DIRITTO DOPPIO
DOUBLE STRAIGHT FITTING

CODICE	+	Ø	◇	☐
340000H162200A	2.2	16x16	10	150
340000H202800A	2.8	20x20	10	100
340000H253500A	3.5	25x25	10	60
340000H324400A	4.4	32x32	5	30
340000H405500A	5.5	40x40	-	14

3400.01RACCORDO DIRITTO MASCHIO
MALE STRAIGHT FITTING

CODICE	+	Ø	◇	☐
340001H031622A	3.2	3/8"x16	10	120
340001H041622A	2.2	1/2"x16	10	120
340001H042028A	2.8	1/2"x20	10	100
340001H051622A	2.2	3/4"x16	10	100
340001H052028A	2.8	3/4"x20	10	80
340001H052535A	3.5	3/4"x25	10	70
340001H102535A	3.5	1"x25	5	50
340001H053244A	4.4	3/4"x32	5	30
340001H103244A	4.4	1"x32	5	30
340001H124055A	5.5	1"1/4x40	-	20

3400.02RACCORDO DIRITTO FEMMINA
FEMALE STRAIGHT FITTING

CODICE	+	Ø	◇	☐
340002RH41622A	2.2	1/2"x16	10	100
340002RH42028A	2.8	1/2"x20	10	100
340002RH51622A	2.2	3/4"x16	10	80
340002RH52028A	2.8	3/4"x20	10	80
340002RH52535A	3.5	3/4"x25	10	60
340002H102535A	3.5	1"x25	5	40
340002H103244A	4.4	1"x32	5	30
340002H124055A	5.5	1"1/4x40	-	14

3400.03RACCORDO DIRITTO RIDOTTO
REDUCED STRAIGHT FITTING

CODICE	+	Ø	◇	☐
340003H685800A	2.8/2.2	20x16	10	150
340003H765800A	3.5/2.2	25x16	5	100
340003H766800A	3.5/2.8	25x20	5	100
340003H825800A	4.4/2.2	32x16	5	50
340003H826800A	4.4/2.8	32x20	5	50
340003H827600A	4.4/3.5	32x25	5	50
340003H868200A	5.5/4.4	40x32	-	14

3400.10 RACCORDO A T
TEE

CODICE	+	Ø	◇	☐
340010H162200A	2.2	16x16x16	10	70
340010H202800A	2.8	20x20x20	10	50
340010H253500A	3.5	25x25x25	5	30
340010H324400A	4.4	32x32x32	5	15

3400.12 RACCORDO A T FEMMINA
FEMALE TEE

CODICE	+	Ø	◇	☐
340012H041622A	2.2	16x1/2"x16	10	50
340012H042028A	2.8	20x1/2"x20	10	40
340012H052028A	2.8	20x3/4"x20	10	40
340012H052535A	3.5	25x3/4"x25	5	25
340012H103244A	4.4	32x1"x32	5	10

3400.13 RACCORDO A T RIDOTTO
REDUCED TEE

CODICE	+	Ø	◇	☐
340013H586858A	2.2/2.8/2.2	16x20x16	10	60
340013H685858A	2.8/2.2/2.2	20x16x16	10	60
340013H685868A	2.8/2.2/2.8	20x16x20	10	60
340013H686858A	2.8/2.8/2.2	20x20x16	10	60
340013H687668A	2.8/3.5/2.8	20x25x20	10	40
340013H765858A	3.5/2.2/2.2	25x16x16	5	50
340013H765868A	3.5/2.2/2.8	25x16x20	5	50
340013H765876A	3.5/2.2/3.5	25x16x25	5	40
340013H766858A	3.5/2.8/2.2	25x20x16	5	30
340013H766868A	3.5/2.8/2.8	25x20x20	5	40
340013H766876A	3.5/2.8/3.5	25x20x25	-	30
340013H767658A	3.5/3.5/2.2	25x25x16	5	30
340013H768276A	3.5/4.4/3.5	25x32x25	-	-
340013H767668A	3.5/3.5/2.8	25x25x20	5	30
340013H825882A	4.4/2.2/4.4	32x16x32	5	20
340013H826876A	4.4/2.8/3.5	32x20x25	5	15
340013H826882A	4.4/2.8/4.4	32x20x32	5	20
340013H827676A	4.4/3.5/3.5	32x25x25	5	15
340013H827682A	4.4/3.5/4.4	32x25x32	5	15

3400.20

ANGOLO DOPPIO
DOUBLE ELBOW



CODICE	+	Ø	◇	☐
340020H162200A	2.2	16x16	10	100
340020H202800A	2.8	20x20	10	70
340020H253500A	3.5	25x25	5	40
340020H324400A	4.4	32x32	5	20

3400.21

ANGOLO MASCHIO
MALE ELBOW



CODICE	+	Ø	◇	☐
340021H041622A	2.2	1/2"x16	10	100
340021H042028A	2.8	1/2"x20	10	80
340021H052028A	2.8	3/4"x20	10	60
340021H052535A	3.5	3/4"x25	5	40
340021H103244A	4.4	1"x32	5	20

3400.22

ANGOLO FEMMINA
FEMALE ELBOW



CODICE	+	Ø	◇	☐
340022H041622A	2.2	1/2"x16	10	100
340022H042028A	2.8	1/2"x20	10	80
340022H051622A	2.2	3/4"x16	10	50
340022H052028A	2.8	3/4"x20	10	60
340022H052535A	3.5	3/4"x25	5	40
340022H102535A	3.5	1"x25	5	40
340022H103244A	4.4	1"x32	5	20

3400.23

ANGOLO CON FLANGIA 2 FORI
WALLPLATE ELBOW WITH 2 HOLES



CODICE	+	Ø	◇	☐
340023H031622A	2.2	3/8"x16 H=40,5	10	60
340023H041622A	2.2	1/2"x16 H=40,5	10	60
340023H041657A	2.2	1/2"x16 H=55,5	10	60
340023H042028A	2.8	1/2"x20 H=41,5	10	50
340023H042057A	2.8	1/2"x20 H=56,5	5	30
340023H052028A	2.8	3/4"x20 H=41,5	10	30
340023H052535A	3.5	3/4"x25 H=46,5	5	30

3400.27 ANGOLO 96°
ELBOW 96°



CODICE	+	Ø	◇	📦
340027H041622A	2.2	1/2"x16	10	80

AC00.90 NERA SCATOLA PER ANGOLO
BOX FOR ELBOW



CODICE	Ø	📦
AC0090H161001H	unica	250

3400.34 ATTACCO A MURO DOPPIO
DOUBLE WALLPLATE ELBOW



CODICE	+	i	Ø	◇	📦
340034H160416A	2.2	fino ad esaurimento scorte	16x1/2"x16	5	15
340034H200420A	2.8	fino ad esaurimento scorte	20x1/2"x20	5	15

3400.34.G ATTACCO A MURO DOPPIO (BRONZO)
DOUBLE WALLPLATE ELBOW (BRONZE)



CODICE	+	Ø	◇	📦
340034G041622A	2.2	16x1/2"x16	-	-
340034G042028A	2.8	20x1/2"x20	5	15

3400.15 RACCORDO DIRITTO EUROCONO CON GIRELLO
STRAIGHT FITTING WITH LOOSE NUT AND
EUROCONE CONNECTION



CODICE	+	Ø	◇	📦
340015H051622A	2.2	3/4"x16	10	100
340015H052028A	2.8	3/4"x20	10	100

3400.C7

RACCORDO DIRITTO SEDE PIANA CON GIRELLO
STRAIGHT FITTING WITH LOOSE NUT AND FLAT
WASHER



CODICE	+	Ø	◇	☐
3400C7H041622A	2.2	1/2"x16	10	180
3400C7H042028A	2.8	1/2"x20	10	120
3400C7H051622A	2.2	3/4"x16	10	120
3400C7H052028A	2.8	3/4"x20	10	100
3400C7H052535A	3.5	3/4"x25	10	100
3400C7H102535A	3.5	1"x25	5	50
3400C7H103244A	4.4	1"x32	5	40

3400.C1

TAPPO
CAP



CODICE	+	Ø	◇	☐
3400C1H162200A	2.2	16	10	200
3400C1H202800A	2.8	20	10	200
3400C1H253500A	3.5	25	5	120

3400.K4

ANGOLO 45°
45° ELBOW



CODICE	+	Ø	◇	☐
3400K4H202800A	2.8	20	10	80
3400K4H253500A	3.5	25	5	40
3400K4H324400A	4.4	32	5	20

3400.82 BUSSOLA
SLEEVE

CODICE	+	Ø	◇	☐
340082R162200A	2.2	16	20	200
340082R202800A	2.8	20	20	160
340082R253500A	3.5	25	20	100
340082R324400A	4.4	32	20	60
340082R405500A	5.5	40	10	40

DIMENSIONI TUBI COMPATIBILI
COMPATIBLE PIPE DIMENSION

Ø TUBO/PIPE		SPESSORE/THICKNESS	
DA/FROM	A/TO	DA/FROM	A/TO
16	16.2	2.2	2.6
20	20.2	2.8	2.9
25	25.2	3.5	3.7
32	32.3	4.4	4.7
40	-	5.5	-

3400.82.P BUSSOLA IN TECNOPOLIMERO
PLASTIC SLEEVE

CODICE	+	Ø	◇
340082P162200A	2.2	16	20
340082P202800A	2.8	20	20
340082P253500A	3.5	25	20
340082P324400A	4.4	32	20

3400.K2 ANGOLO CONNESSIONE RADIATORE
RADIATOR JOINT ELBOW

CODICE	+	Ø	◇	☐
3400K2N161500A	2.2	16x15/250	2	20
3400K2N161550A	2.2	16x15/500	2	30
3400K2N161510A	2.2	16x15/1000	2	60
3400K2N201500A	2.8	20x15/250	2	14

3400.K2.I ANGOLO CONNESSIONE RADIATORE (INOX)
RADIATOR JOINT ELBOW (STAINLESS STEEL)



CODICE	+	Ø	◇	☐
3400K2I161500A	2.2	16x15/250	2	20
3400K2I161510A	2.2	16x15/1000	2	60

3400.K8 RACCORDO A T PER RADIATORE
TEE FOR RADIATOR



CODICE	+	Ø	◇	☐
3400K8N161516A	2.2/2.2	16x15x16/250	2	20
3400K8N161520A	2.2/2.8	16x15x20/250	2	20
3400K8N161550A	2.2	16x15x16/500	2	30
3400K8N161510A	2.2	16x15x16/1000	-	-
3400K8N201516A	2.8/2.2	20x15x16/250	2	20
3400K8N201520A	2.8/2.8	20x15x20/250	2	14
3400K8N201550A	2.8	20x15x20/500	2	20
3400K8N201510A	2.8	20x15x20/1000	-	-
3400K8N201525A	2.8/3.5	20x15x25/250	2	14
3400K8N251520A	3.5/2.8	25x15x20/250	2	14
3400K8N251525A	3.5/3.5	25x15x25/250	2	14
3400K8N251550A	3.5	25x15x25/500	2	20

AC00.90.K2 STAFFA DI FISSAGGIO PER TUBI DI COLLEGAMENTO RADIATORE
 RADIATORE
 FIXING BRACKET FOR L-SHAPE RADIATOR TUBES



CODICE	
AC0090H3400K2H	25

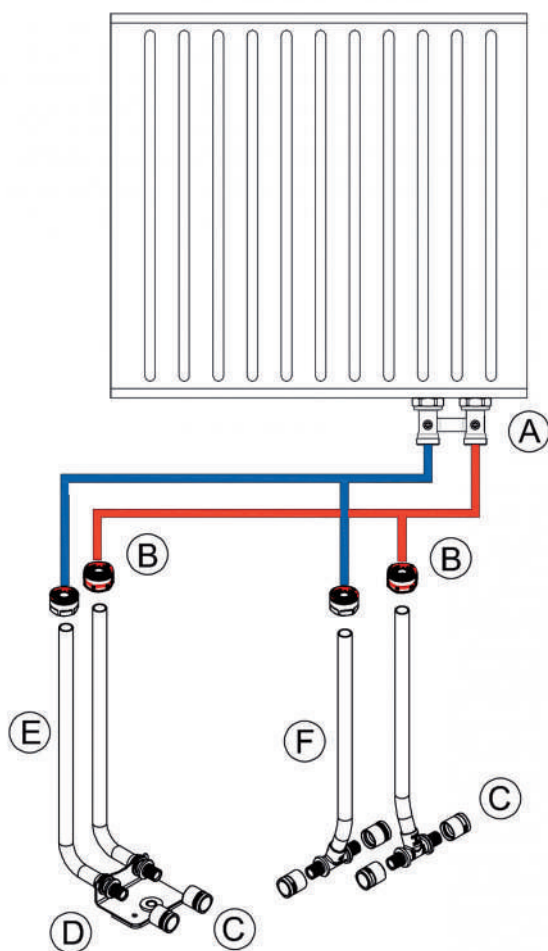

(A)	7E00E3N050500A 	
(A)	7E00E3N050590A 	
(B)	5700H4N051500A 7E00H4N051500A 	
(C)	3400.82 3400.82P 	
(D)	AC0090H3400K2H 	
(E)	3400.K2 	
(F)	3400.K8 	

AC00.70 CURVA REGGITUBO IN PLASTICA
PLASTIC BEND FOR PIPE



CODICE	Ø	◇	☐
AC0070H160000H	15-16	20	40
AC0070H200000H	20-22	15	15
AC0070H250000H	25	10	10

La curva reggitubo è utilizzata per la curvatura a freddo delle tubazioni. Serve inoltre a sostenere i tubi e a proteggerli da eventuali urti.

The pipe holder bend is used for cold bending of pipes. It is also used to support the pipes and protect them from possible impacts.

AC00.80 PE-X CURVA REGGITUBO PER TUBO PE-X
BEND FOR PE-X PIPE



CODICE	Ø	◇	☐
AC0080H160000H	15-16	60	120
AC0080H180000H	18	40	40
AC0080H200000H	20-22	25	25
AC0080H250000H	25	10	20

La curva reggitubo è utilizzata per la curvatura a freddo delle tubazioni. Serve inoltre a sostenere i tubi e a proteggerli da eventuali urti.

The pipe holder bend is used for cold bending of pipes. It is also used to support the pipes and protect them from possible impacts.

AC0094HESP ANSO ESPANSORE MANUALE
MANUAL EXPANDER



CODICE
AC0094HESPANSO

AC00.80 MKV TESTINA ESPANSORE MANUALE RH MKV PER TUBO
MULTISTRATO
EXPANDER HEADS RH MKV FOR MULTILAYER PIPE



CODICE	+	Ø
AC0080MKV16260	2.6	16
AC0080MKV20290	2.9	20
AC0080MKV25370	3.7	25
AC0080MKV32470	4.7	32

AC00.80 HIS TESTINA ESPANSORE MANUALE RH HIS PER TUBO PE-X
EXPANDER HEADS RH HIS FOR PE-X PIPE



CODICE	+	Ø
AC0080HIS16220	2.2	16
AC0080HIS20280	2.8	20
AC0080HIS25350	3.5	25
AC0080HIS32440	4.4	32

AC0094H340 SET COMPLETO
OSET MANUAL INSTALLATION KIT



CODICE

AC0094H3400SET

Pressatrice manuale per tubo Pe -X e multistrato, set di ganasce (16-20; 25-32), tagliatubi, espansore manuale, espansori (16x2.2-20x2.8-25x3.5-32x4.4)

Manual press machine for Pe-X and Pe-X/Al/Pe-X pipe:set of jaws (16-20; 25-32), pipe cutter, manual expander, expanders (16x2.2-20x2.8-25x3.5-32x4.4)

AC00.91HA MACCHINA DI PRESSATURA AUTOMATICA
AUTOMATIC PRESSING MACHINE



CODICE

AC0091HAX21625

Set compatibile con ganasce Ø 16-20-25-32.

Set of pressing machine with jaws 16-20-25-32.

AC0094HEPR KIT PER TUBO MULTISTRATO
KIT FOR MULTILAYER PIPE



CODICE

AC0094HEPR1625

Il kit di attrezzature può essere utilizzato solo con tubi multistrato con spessore aumentato (2.6-2.9-3.7-4.7)

It can only be used for multilayer pipes with increased thicknesses (2.6-2.9-3.7-4.7)

AC0094HEPS KIT PER TUBO PE-X
KIT FOR PE-X PIPE



CODICE

AC0094HEPS1625

AC00.80.R GANASCIA RE PER MACCHINA DI PRESSATURA
AUTOMATICA
AUTOMATIC PRESS MACHINE COMPRESSION RE
HEAD



CODICE

Ø

AC0080R160000H

16

AC0080R200000H

20

AC0080R250000H

25

AC0080R320000H

32

AC00.80

STAFFA ATTACCO A MURO CON VITI 7.5°/15°
WALL FIXING BRACKET AND SCREWS 7.5°/15°

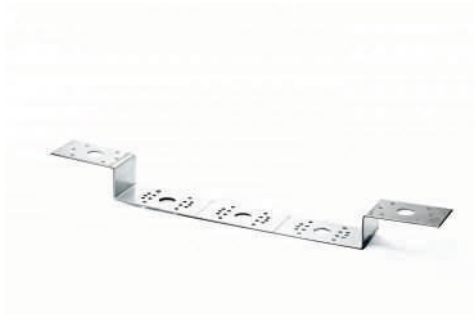

CODICE

+

☐

AC0080H75B506H

1.5 mm

12

AC0080H75B5P6H

2.5 mm

12

Staffa sagomata per fissaggio a muro per raccordo gomito femmina con flangia, in acciaio zincato 1.5 mm/2.5 mm, profondità sagomatura 30 mm, simmetrica, interasse di posa 75 - 150 mm, inclinazioni possibili 0°/7.5°/15°. Applicabile su qualsiasi supporto (cartongesso, legno, muratura). Lunghezza 370 mm. Completa di viti per fissaggio raccordi.

Sectionable bracket with screws. Moulded bracket for female elbow with flange fastening to wall, zinc-plated 1.5/2.5 mm, mould depth 30 mm, symmetrical, laying distance center to center 75 - 150 mm, possible grade 0°/7.5°/15°. It is suitable for any support (plasterboard, wood, masonry). Length 370 mm. Together with screws for fittings fastening.



Gold-Therm

SERIE 3400

LINE 3400



Raccordi a pressatura assiale per tubo PE-X

Axial press fittings for Pe-X pipes

I raccordi a pressatura assiale della serie 3400 GOLD-THERM sono utilizzabili per impianti di riscaldamento e raffrescamento a pannelli radianti.

I raccordi e le bussole del sistema GOLD-THERM non sono intercambiabili con i raccordi e le bussole del sistema GOLD-FIX.

3400 GOLD-THERM fittings are suitable for heating and cooling systems with radiant panels.

GOLD-THERM fittings and sleeves are not interchangeable with GOLD-FIX fittings and sleeves.



VANTAGGI

- Installazione sicura: collegamento a tenuta stagna, senza punti di ristagno e senza richiedere O-ring o ulteriori guarnizioni
- Maggiore passaggio di acqua e di conseguenza minori perdite di carico
- Trattamento termico della bussola che garantisce maggiore plasticità, maggiore capacità di deformazione e minore possibilità di rottura in esercizio
- Grande affidabilità nel tempo
- Materie prime impiegate di alta qualità [UBA LIST]

ADVANTAGES

- *Safe installation: watertight connection, without stagnation points and without requiring O-rings or additional gaskets*
- *Greater water flow and consequently lower pressure drops*
- *Heat treatment of the bush which guarantees greater plasticity, greater deformation capacity and less chance of breakage*
- *Great reliability over time*
- *Raw materials complying with UBA LIST*

CAMPI DI APPLICAZIONI E PRESTAZIONI FIELDS OF APPLICATION

APPLICAZIONI APPLICATIONS		T. min.	T. max	T. di sistema T. of the system	Press.max Max. pressure
 raffrescamento cooling		-20°C	+120°C	-20°C/+95°C	10 bar
 riscaldamento a pavimento floor heating		-20°C	+120°C	-20°C/+95°C	10 bar
	-20°C: solo con liquido antigelo glicole in % max del 30% -20°C: with the use of glycol in a maximum percentage of 30%				

COMPONENTI E MATERIALI COMPONENTS AND MATERIALS



LEGENDA LEGEND	COMPONENTI COMPONENTS	MATERIALI MATERIALS
1	Bussola Sleeve	Ottone CW612N - UNI EN 12164 Brass CW612N - UNI EN 12164
2	Corpo Body	Ottone CW617N - UNI EN 12165 Brass CW617N - UNI EN 12165

TUBI COMPATIBILI

I raccordi della serie 3400 GOLD-THERM sono utilizzabili con tubi in polietilene reticolato PE-Xa.

Per la lista completa e le caratteristiche delle tubazioni fornite da General Fittings fare riferimento al catalogo ufficiale o visitare il sito www.generalfittings.it

SUITABLE PIPES

Fittings of line 3400 GOLD-THERM are suitable for installation with PE-Xa pipes.

For the complete list of available pipes refer to the catalogue or visit the website www.generalfittings.it

NORMATIVE

- UBA LIST

Conforme a 4MS, UBA List (gruppo BC), DIN 50930/6 Dir. 2011/65/UE, 6C allegato III (RhOSII)

- UNI EN ISO 15875-3

I raccordi sono conformi alla norma UNI EN ISO 15875-3: "Sistemi di tubazioni di materie plastiche per le installazioni di acqua calda e fredda".

- UNI EN 1254-3

I raccordi sono conformi alla norma UNI EN 1254-3: "Raccorderia idraulica per tubazioni di plastica con terminali a compressione".

- UNI EN 12226-1

Tutte le filettature sono conformi alla norma UNI EN 12226-1: "Filettatura di tubazioni per accoppiamento con tenuta sul filetto".

REGULATIONS

- UBA LIST

Comply with 4MS, UBA List (BC group), DIN 50930/6 Dir. 2011/65/UE, 6C attachment III (RhOSII).

- UNI EN ISO 15875-3

Fittings comply with UNI EN ISO 15875-3 law: "Plastic piping systems for hot and cold water installations - Crosslinked polyethylene (PE-X) - Part 3: Fittings".

- UNI EN 1254-3

Fittings comply with UNI EN 1254-3 law: "Sanitary fittings for plastic pipes with compression ends".





- UNI EN 12226-1

Threads comply with UNI EN 10226-1 law: "Piping thread for coupling on the thread".

DIAMETRO TUBO - SVASATORI E GANASCE PIPE DIAMETERS - REAMERS AND JAWS

Pe-X		
Ø tubo Ø pipe	Svasatore Reamer	Ganascia Jaw
17 x 2.0	RH-HAS	RH 17
20 x 2.0	RH-HAS	RH 20

CERTIFICAZIONI CERTIFICATIONS

STATO COUNTRY	CERTIFICAZIONE CERTIFICATION	STATO COUNTRY	CERTIFICAZIONE CERTIFICATION
			

AVVERTENZE

Le seguenti istruzioni sono da applicare a sistemi definiti per raccordi GOLD-THERM e tubo PE-Xa (dimensioni 17-20) con barriera ossigeno.

Utilizzare sempre macchine e attrezzature definite nel catalogo generale General Fittings.

Il senso della bussola NON è reversibile. La marcatura della bussola deve essere sempre opposta alla direzione di inserimento del tubo.

Il tubo General Fittings PE-Xa è dotato di barriera intrusione ossigeno. La barriera anti-ossigeno non è però flessibile come il tubo in polietilene e potrebbe lacerarsi nella fase di espansione del tubo, soprattutto alle basse temperature. Questo però non influisce sulla sicurezza e garanzia di tenuta.

Qualora la fase di espansione venga eseguita troppo velocemente e a temperature sotto lo zero, anche lo strato del tubo PE-Xa, oltre la barriera ossigeno, potrebbe danneggiarsi e lacerarsi. In questo caso deve essere necessariamente asportata la parte di tubo che risulta danneggiata e ripetere l'operazione.

Macchina manuale e macchina ad azionamento elettrico: la macchina manuale è applicabile a sistemi PE-Xa nelle dimensioni 17-20.

La macchina ad azionamento elettrico è applicabile a sistemi PE-Xa nelle dimensioni 17-20.

Proteggere raccordi e manicotti prima del contatto con la muratura da fluidi e altre sostanze aggressive attraverso un adeguato rivestimento.

Per indicazioni tecniche di prodotto rivolgersi direttamente all'Ufficio Tecnico di General Fittings Spa.

INSTRUCTIONS

The following instructions have to be applied to systems defined for GOLD-THERM fittings and PE-Xa pipe with oxygen barrier (dimensions 17-20).

Always use machines and equipments defined in General Fittings catalogue.

The direction of the sleeve is NOT reversible. The marking of the sleeve must always be opposite to the direction of pipe insertion.

General Fittings PE-Xa pipe is equipped with an oxygen barrier. The oxygen barrier is not flexible like the polyethylene pipe and could tear in the expansion phase of the pipe, especially at low temperatures. However, this does not affect safety and guarantee of the tightness.

If the expansion phase is made too quickly and at temperatures below 0°C, even the layer of PE-Xa pipe can be damaged, beside the oxygen barrier. In this case the damaged part of the pipe must be removed and repeated the operation.

General Fittings Multilayer PE-Xa pipe is equipped with an oxygen barrier. If the expansion phase is carried out too quickly and at temperatures below zero, the layer of the PE-Xa pipe be damaged and lacerated. In this case the damaged part of the pipe must be removed and repeated the operation.

Manual machine and electrically operated machine: the manual machine is suitable for systems with PE-Xa pipe in sizes 17-20. The electrically operated machine it is suitable for PE-Xa pipes in sizes 17-20.

Fittings and sleeves must be protected before putting in contact with masonry from fluids and other aggressive substances by a suitable coating.

For any technical product information please contact directly the Technical Department of General Fittings Spa.

ISTRUZIONI DI MONTAGGIO ASSEMBLY INSTRUCTIONS

Prima di eseguire il taglio del tubo verificare che il tubo non presenti difetti superficiali e che la marcatura sia leggibile e completa in ogni sua parte

Before cutting the pipe, check that the pipe has no surface defects and that the marking is readable and complete in all its parts

Verificare sempre che la lama della cesoia sia perfettamente affilata e tagliente, priva di ammaccature o parti danneggiate

Always check that the shear blade is perfectly sharp, without dents or damaged parts

Utilizzando un apposito utensile taglia tubi [codice TT50.00] eseguire un taglio perpendicolare all'asse del tubo.

Cut the pipe perpendicularly to its axis using an appropriate pipe-cutting tool [code TT500.00].

Il taglio deve essere sempre effettuato sulla parte dritta del tubo a una distanza minima di 150mm dal raccordo precedente o a una distanza minima di 20mm dalla fine del raggio di piegatura del tubo.

Il taglio deve essere netto, senza sbavature interne od esterne al tubo.

*The cut must always be made on the straight part of the pipe at a minimum distance of 150mm from the closest fitting or at a minimum distance of 20mm from the pipe's bend ending.
The cut must be clean, without pipe internal or external burs.*

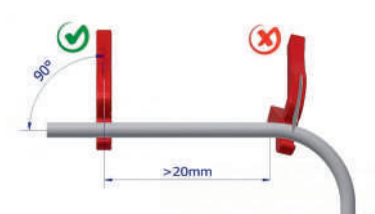
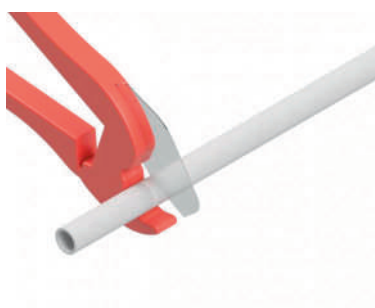

Verificare che l'espansore non sia danneggiato e che si avviti fino a battuta. Una volta avvitato l'espansore non deve svitarsi durante la rotazione del tubo sull'espansore. Verificare che l'attrezzo utilizzato sia corretto e definito per il tubo che stiamo per assemblare. Inserire l'espansore senza forzature e parallelo all'asse del tubo.



Check that the expander is not damaged and it is screwed up to the end. Once screwed the expander shouldn't unscrew during the rotation of the pipe on the expander. Verify that the tool we are going to use is correct and studied for the pipe we are going to assemble. Insert the expander without forcing and parallel to the axis of the pipe.

Inserire la bussola sul tubo, verificando che la marcatura sia opposta al taglio del tubo e che tra la fine del tubo e la bussola ci sia una distanza doppia rispetto alla bussola.

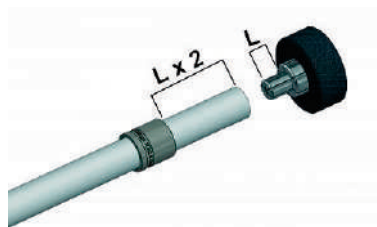

Insert the sleeve into the pipe, making sure that the marked strip is opposite to the cut of the pipe and that there is double distance compared to the sleeve between the end of the pipe and the sleeve itself.

Allargare in maniera graduale e omogenea il tubo senza scaldare le parti in deformazione. Le temperature consigliate nella fase di svasatura a freddo possono andare da -10°C a 50°C.

NB: in funzione della tipologia di tubo, utilizzare l'ideale svasatore.

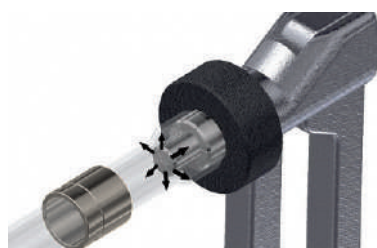

Gradually and homogeneously widen the pipe without heating the deforming parts. Temperatures recommended during this flaring phase go from -10° C to +50 °C.

NB: according to the different pipes, use the appropriate reamer.

L'operazione di espansione deve essere ripetuta almeno una seconda volta ruotando l'attrezzatura di 30°. Se la parte interna del tubo non risulta perfettamente cilindrica, ripetere ancora le operazioni descritte.

The expansion operation must be repeated at least a second time by turning the equipment by 30°. If the internal part of the pipe is not perfectly cylindrical, repeat the described operations again.



Tagliare i tubi che non presentano una circolarità regolare dopo l'espansione e scartare lo spezzone di tubo non conforme. Sostituire gli espansori che risultano danneggiati o non permettono la perfetta circolarità del tubo allargato. L'espansore difettoso può provocare problemi di tenuta nel tempo.

Ingrassare il cono dell'espansore qualora l'azionamento della macchina risulti difficoltoso.

Qualora si presentassero, dopo l'espansione, delle fessurazioni o delle crepe del tubo, eliminare il tubo danneggiato e ripetere l'operazione di espansione.

Cut pipes which are not circular adjust after expansion and waste the piece of non-conformed pipe. Replace expanders which are damaged or do not allow perfect circularity of the enlarged pipe. The defective expander can cause sealing problems over time.

Grease the expander cone if the actuation of the tool is difficult. If, after the expansion, there are cracks or slots on the pipe, remove the damaged tube and repeat the expansion operation.



Se tutte le procedure per l'espansione del tubo sono state rispettate, il tubo si infilerà sul raccordo senza forzature, se eventualmente ci fosse difficoltà nell'inserimento del tubo, ripetere le operazioni di espansione.

If all recommended procedures for the expansion of the pipe have been adopted, the pipe will slide onto the fitting without forcing. If the insertion of the pipe is difficult, repeat the above mentioned expansion operations.



Il tubo ha un effetto di ritorno naturale (effetto memory). Le operazioni di assemblaggio tubo e raccordo devono essere quindi effettuate in tempi brevi. Tutte le nervature di tenuta del raccordo devono essere avvolte dal tubo inserito manualmente.

The pipe has a natural return effect (memory effect). Pipe and fitting assembly operations must therefore be carried out quickly. All sealing ribs of the fitting must be covered by the pipe inserted manually.



MANUALE: Spingere la bussola verso il raccordo. Posizionare gli elementi nelle ganasce della macchina pressatrice, prestando attenzione che la bussola e il collarino del raccordo siano correttamente alloggiati in battuta alla ganasce.

MANUAL: Push the sleeve towards the fitting. Put the elements in the jaws of the pressing machine, making sure that the sleeve and the fitting collar are inserted properly.



AUTOMATICA: Spingere la bussola verso il raccordo. Posizionare gli elementi nelle ganasce della macchina pressatrice, prestando attenzione che la bussola e il collarino del raccordo siano correttamente alloggiati in battuta alla ganasce.

AUTOMATIC: Push the sleeve towards the fitting. Put the elements in the jaws of the pressing machine, making sure that sleeve and fitting collar are inserted properly.



Azionare la pressatrice.

Start the pressing machine.

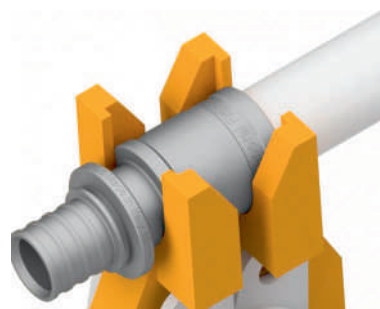

Verificare che la bussola montata sia in battuta con il corpo del raccordo.

Make sure that the assembled sleeve is up the stroke of the fitting's body.

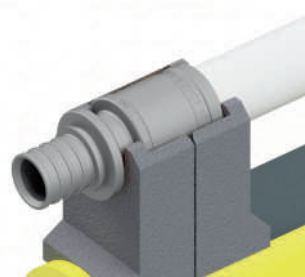

Posizionare sempre il tubo e la bussola in battuta.

Put pipe and sleeve in abutment.

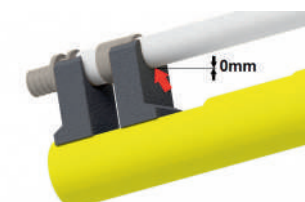

Verificare che la bussola e il raccordo siano sempre inserite nella corretta posizione.

Check that sleeve and fitting are always inserted in the correct position.

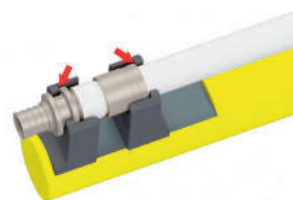

Il posizionamento perpendicolare permette un montaggio coassiale della bussola.

The perpendicular positioning allows a coaxial assembly of the sleeve.

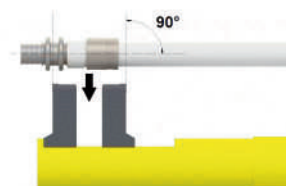

3400.00.N RACCORDO DRITTO DOPPIO NICHELATO
NICKEL-PLATED DOUBLE STRAIGHT FITTING



CODICE	+	Ø	◇	☐
340000N172000A	2.0	17x17	-	-
340000N202000A	2.0	20X20	10	100

3400.01.N RACCORDO DRITTO MASCHIO NICHELATO
NICKEL-PLATED MALE STRAIGHT FITTING



CODICE	+	Ø	◇	☐
340001N041720A	2.0	1/2"x17	-	-
340001N042020A	2.0	1/2"x20	10	100

3400.82.N BUSSOLA NICHELATA
NICKEL PLATED SLEEVE



CODICE	+	Ø	◇	☐
340082N172000A	2.0	17	-	-
340082N202000A	2.0	20	20	160

3400.15.N RACCORDO DIRITTO EUROCONO CON GIRELLO
STRAIGHT FITTING WITH LOOSE NUT AND
EUROCONE CONNECTION



CODICE	+	Ø
340015N051720A	2.0	3/4"x17

AC00.80 HAS TESTINA ESPANSORE MANUALE RH HAS PER TUBO
PE-X
EXPANDER HEADS RH HAS FOR PE-X PIPE



CODICE	+	Ø
AC0080HAS17200	2.0	17
AC0080HAS20200	2.0	20

AC0094HESP ANSO ESPANSORE MANUALE
MANUAL EXPANDER



CODICE
AC0094HESPANSO

AC00.80.R GANASCIA RH PER MACCHINA DI PRESSATURA
AUTOMATICA
AUTOMATIC PRESS MACHINE COMPRESSION RH
HEAD



CODICE	Ø
AC0080RH17000M	17
AC0080RH20000M	20



TUBO PE-X

PE-X PIPE

Tubazioni PE-Xa con barriera EVOH

PE-Xa pipes with EVOH barrier



Il tubo Pe-Xa (polietilene reticolato con il metodo a perossidi) della serie TB00.30 può essere utilizzato per la distribuzione di acqua calda e fredda sanitaria, sistemi di riscaldamento a radiatori, sistemi di riscaldamento e raffrescamento a pannelli radianti, impianti per aria compressa, impianti per il trasporto di sostanze chimiche o derivati da petrolio.

Le tubazioni TB00.30 vengono estruse con una barriera anti-ossigeno esterna in EVOH, in conformità alla norma DIN 4726, grazie alla quale il modesto quantitativo di ossigeno che dall'esterno permea verso l'interno del tubo diventa del tutto trascurabile.

I tubi utilizzati per l'acqua potabile non necessitano della barriera antiossigeno.

The Pe-Xa pipe (polyethylene cross-linked with the peroxide method) of the TB00.30 series can be used for the distribution of domestic hot and cold water, radiator heating systems, radiant panel heating and cooling systems, air systems compressed air, chemical or petroleum-based transport systems.

TB00.30 pipes are extruded with an external anti-oxygen barrier in EVOH, in accordance with DIN 4726, thanks to which the modest amount of oxygen that permeates from the outside towards the inside of the pipe becomes completely negligible.

The pipes used for drinking water do not need the oxygen barrier.









VANTAGGI

- Elevata flessibilità: facile da installare (in particolare nei sistemi a pannelli radianti)
- Resistente a -100°C e per brevi periodi a $+110^{\circ}\text{C}$
- Memoria termica: se il tubo è stato piegato può tornare alla forma originale se riscaldato ($>133^{\circ}\text{C}$)
- Resistenza chimica: resistente ai fenomeni di criccatura e a molteplici agenti chimici
- Resistente alla propagazione delle fessurazioni
- Resistente all'abrasione
- Bassa caduta di pressione e nessun rischio di deposito di sedimenti
- Eccellenti proprietà di isolamento elettrico

ADVANTAGES

- *High flexibility: easy to install (especially in radiant panel systems)*
- *Resistant to -100°C and for short periods to $+110^{\circ}\text{C}$*
- *Thermal memory: if the pipe has been bent it can return to its original shape when heated ($>133^{\circ}\text{C}$)*
- *Chemical resistance: resistant to cracking phenomena and multiple chemical agents*
- *Resistant to crack propagation*
- *Resistant to abrasion*
- *Low pressure drop and no risk of sediment deposition*
- *Excellent electrical insulation properties*

CAMPI DI APPLICAZIONI E PRESTAZIONI FIELDS OF APPLICATION

APPLICAZIONI APPLICATIONS		T. di sistema T. of the system
	acqua potabile drinking water	-20°C/+95°C
	acqua calda sanitari hot sanitary water	-20°C/+95°C
	raffrescamento cooling	-20°C/+95°C
	condizionamento conditioning	-20°C/+95°C
	radiatori radiators	-20°C/+95°C
	riscaldamento a pavimento floor heating	-20°C/+95°C
	irrigazione irrigation	-20°C/+95°C
	aria compressa compressed air	-20°C/+95°C

COMPOSIZIONE COMPOSITION



COMPOSIZIONE STRATI LAYER COMPOSITION

Strato interno in PE-Xa, polietilene reticolato Inner layer in PE-Xa, cross-linked polyethylene
Colla Glue
Barriera EVOH EVOH barrier

POLIETILENE RETICOLATO (PE-X)

Il polietilene è un materiale polimerico termoplastico composto da numerose molecole lunghe che, anche a temperature moderatamente elevate (ancora sotto il punto di fusione), comincia ad avere un significativo grado di fluidità.

Con il processo di reticolazione le molecole di polietilene si legano insieme per formare una struttura tridimensionale più complessa: la reazione chimica di reticolazione trasforma infatti il prodotto da termoplastico a termoindurente. Il materiale subisce una modificazione strutturale che ne migliora le caratteristiche quali l'abrasione, la resistenza chimica e la resistenza meccanica nel tempo. Le prestazioni del materiale vengono incrementate significativamente.

Vi sono diverse tecnologie per ottenere la reticolazione del

CROSS-LINKED POLYETHYLENE (PE-X)

Polyethylene is a thermoplastic polymeric material composed of numerous long molecules that, even at moderately high temperatures (still below the melting point), begins to have a significant degree of fluidity. With the crosslinking process, the polyethylene molecules bind together to form a more complex three-dimensional structure: the chemical crosslinking reaction transforms the product from thermoplastic to thermosetting. The material undergoes a structural modification that improves its characteristics such as abrasion, chemical resistance and mechanical resistance over time. The performance of the material is significantly increased.

There are different technologies to obtain the crosslinking of polyethylene.

In the case of Pe-Xa, the inner layer of the pipe is cross-

polietilene.

Nel caso del Pe-Xa lo strato interno del tubo è reticolato con metodo a perossidi. L'estrusione avviene a temperature inferiori a 160-170°C per evitare che i perossidi miscelati al polietilene inizino prematuramente la reticolazione che avviene in un secondo momento facendo passare il tubo estruso in forno verticale a raggi infrarossi con temperature di 220-230°C.

Il processo di peroxide cross-linking technology offre così elevate prestazioni meccaniche del tubo Pe-Xa. La qualità del tubo non dipende dal metodo di reticolazione, bensì dalla sua capacità di superare i test fisici e meccanici definiti dalle normative.

linked with the peroxide method. The extrusion takes place at temperatures below 160-170 °C to prevent the peroxides mixed with polyethylene from prematurely starting cross-linking which occurs later by passing the extruded tube in a vertical infrared oven with temperatures of 220-230 °C. The peroxide cross-linking technology process thus offers high mechanical performance of the Pe-Xa pipe. The quality of the pipe does not depend on the crosslinking method, but on its ability to pass the physical and mechanical tests defined by the regulations.

BARRIERA ALL'OSSIGENO (EVOH)

Tutti i sistemi di riscaldamento e di raffreddamento sono soggetti all'ingresso di ossigeno attraverso raccordi filettati, caldaia, pompe e materiali permeabile al gas. L'ossigeno può introdursi negli impianti in quantità tale che, in combinazione con altri fattori, può causare effetti corrosivi.

La barriera di penetrazione all'ossigeno utilizzata nei tubi Pe-Xa di General Fittings riduce la quantità di ossigeno ben al di sotto dei limiti richiesti dalla normativa DIN 4726 (0,32 mg O₂/m² - d a 40°C o 2/m² d a 80°C)

EVOH BARRIER

All heating and cooling systems are subject to the entry of oxygen through threaded fittings, boiler, pumps and gas-permeable materials.

Oxygen can enter the systems in such quantities that, in combination with other factors, it can cause corrosive effects.

The oxygen penetration barrier used in General Fittings Pe-Xa pipes reduces the amount of oxygen below the limits required by DIN 4726 (0.32 mg O₂ / m² - from 40 °C or 2 / m² from 80 °

DATI TECNICI TECHNICAL DATA

Proprietà Properties	Valore Value	Metodo del test Test method
Campo di impiego Fields of application	Classe 1,2,3,5 Class 1,2,3,5	EN ISO 15875
Grado di reticolazione Degree of crosslinking	≥70%	EN ISO 10147
Densità Density	0,935 g/cm ³	ISO 1183, metodo D ISO 1183, method D
Coefficiente di espansione termica Coefficient of thermal expansion	1,8 · 10 ⁻⁴ K ⁻¹	DIN 52328
Conduttività termica Thermal conductivity	<0,4 W/m K	DIN 52612
Allungamento fino a rottura Elongation to break	>400%	ISO 6259
Resistenza alla trazione Tensile strength	25 MPa	ISO 6259
Fattore di rugosità Roughness factor	0.0005	

CONDIZIONI DI SERVIZIO

I tubi Pe-Xa per l'acqua potabile sono testati e approvati per resistere ad una pressione di 10 bar ad una a 90°C. I tubi Pe-Xa per gli impianti di riscaldamento a pavimento possono resistere ad una pressione di 6 bar a 70°C con picchi a 95°C per oltre 50 anni.

Di seguito i requisiti di comportamento per i sistemi di tubazioni secondo la norma UNI 15875.

TERMS OF SERVICE

Pe-Xa pipes for drinking water are tested and approved to withstand a pressure of 10 bar at 90 °C. Pe-Xa pipes for underfloor heating systems can withstand a pressure of 6 bar at 70 °C with peaks at 95 °C for over 50 years.

Below are the behavioral requirements for piping systems according to the UNI 15875 standard.

Classe Class	TD (°C)	T a TD (ANNI) T at TD (YEARS)	T max (°C)	T a T max (ANNI) T at T max (YEARS)	T mal (°C)	Tempo a T mal (ore) Time at T mal (hours)	Campi di applicazione Typical Field of application
Acqua fredda Cold water	20	50					acqua fredda idrosanitaria Sanitary cold water
1a	60	49	80	1	95	100	acqua calda sanitaria (60°C) sanitary hot water (60°C)
2a	70	49	80	1	95	100	Acqua calda sanitaria (70°C) Sanitary hot water (70°C)
4b	20	2.5	70	2.5	100		riscaldamento a pavimento e radiatori a bassa temperatura underfloor heating and low temperature radiators
4b	40	20	70	2.5	100		riscaldamento a pavimento e radiatori a bassa temperatura underfloor heating and low temperature radiators
4b	60	25	70	2.5	100		riscaldamento a pavimento e radiatori a bassa temperatura underfloor heating and low temperature radiators
5b	20	14	90	1	100		riscaldamento con radiatori ad alta temperatura heating with high temperature radiators
5b	60	25	90	1	100		riscaldamento con radiatori ad alta temperatura heating with high temperature radiators
5b	80	10	90	1	100		riscaldamento con radiatori ad alta temperatura heating with high temperature radiators

PRECAUZIONI

Alcune prescrizioni sono necessarie per garantirne la durata e la funzionalità delle tubazioni in PEX:

- 1) Immagazzinare le tubazioni negli appositi imballi, evitando la loro esposizione diretta ai raggi solari, ed in luoghi coperti ed asciutti
- 2) Evitare che le tubazioni vengano a contatto con corpi taglienti e prestare cura durante il trasporto e l'installazione
- 3) Evitare la formazione del ghiaccio all'interno delle tubazioni e degli imballi, perché le dilatazioni dovute al passaggio di stato potrebbero causarne la rottura.
- 4) Evitare che le tubazioni vengano a contatto in qualunque modo con fiamme libere o con altre fonti di calore, in grado di provocarne fusioni anche parziali.
- 5) Evitare il contatto con solventi chimici o vernici che possano danneggiare le tubazioni.



CAUTIONS

Some prescriptions are necessary to guarantee the durability and functionality of PEX pipes:

- 1) Store the pipes in the appropriate packaging and in covered and dry places, avoiding their direct exposure to sunrays*
 - 2) Avoid that the pipes to get in contact with sharp objects and take care during transport and installation*
 - 3) Avoid the formation of ice inside the pipes and packaging, because the expansion due to the change of state could cause them to break.*
 - 4) Avoid that the pipes come into contact in any way with open flames or other heat sources, which could cause even partial melting.*
- Avoid contact with chemical solvents or paints that can damage the pipes.*

TB00.30 PE-X TUBO PE-XA BARRIERA EVOH
PE-Xa PIPE WITH EVOH BARRIER



CODICE	Ø		
TB0030G162200B	16x2.2	100 m	2700 m
TB0030G202800B	20x2.8	100 m	1800 m
TB0030G253500B	25x3.5	50 m	900 m
TB0030G324400B	32x4.4	50 m	900 m

Disponibile a richiesta

Available on demand

TB00.30.R TUBO PE-XA BARRIERA EVOH
PE-Xa PIPE WITH EVOH BARRIER



CODICE	i	Ø	
TB0030R160020B	rosso	16x2.0	200 m
TB0030R162060B	rosso	16x2.0	600 m
TB0030R172030H	rosso	17x2.0	300 m
TB0030R172060H	rosso	17x2.0	600 m
TB0030R202020B	rosso	20x2.0	200 m
TB0030R202050B	rosso	20x2.0	500 m



Tubi multistrato a pressatura assiale

Multilayer pipes for axial press fittings



Il tubo Multistrato della serie TB00.20 SYLVER è contraddistinto da una struttura di 5 strati in cui uno strato di alluminio saldato testa a testa è racchiuso tra due strati di polietilene reticolato (PEX) e fissato a questi ultimi mediante due veli di adesivo.

Grazie a questa caratteristica il tubo della serie TB00.20 SYLVER rappresenta un perfetto connubio tra le proprietà della plastica (polietilene reticolato alta resistenza meccanica) e del metallo duttile (Alluminio alta flessibilità), in cui i pregi del PEX si sommano a quelli dell'alluminio dando vita ad un prodotto dalle straordinarie e molteplici qualità.

Il PEX conferisce resistenza chimica, resistenza alla corrosione, leggerezza, igienicità e garantisce una superficie di contatto con il fluido trasportato molto liscia e levigata tale da ridurre le perdite di carico ed evitare incrostazioni.

La presenza di alluminio consente di poter modellare il tubo con estrema semplicità in modo da velocizzare notevolmente l'installazione ed impedire il passaggio di ossigeno all'interno della condotta. Il tubo è idoneo per impianti sanitari, di riscaldamento, di raffrescamento e aria compressa.

The multilayer pipe of the TB00.20 SYLVER series is characterized by a 5-layer structure in which a butt-welded aluminum layer is enclosed between two layers of cross-linked polyethylene (PEX) and fixed to the latter by two layers of adhesive.

Thanks to this feature, TB00.20 SYLVER pipe represents a perfect combination of the properties of plastic (cross-linked polyethylene with high mechanical resistance) and ductile metal (highly flexible aluminum), in which the qualities of PEX are added to those of aluminum, giving life to a product with extraordinary and multiple qualities. PEX confers chemical resistance, corrosion resistance, lightness, hygiene and guarantees a very smooth and polished surface in contact with the transported fluid such as to reduce pressure drops and avoid encrustations. The presence of aluminum allows the pipe to be modeled very easily in order to significantly speed up installation and prevent the passage of oxygen inside the pipeline. The pipe is suitable for sanitary, heating, cooling and compressed air systems.

VANTAGGI

- Eccellente isolamento acustico: l'elasticità del polietilene reticolato consente di ottenere un ottimo assorbimento delle vibrazioni
- Resistenza alla corrosione e all'abrasione
- Leggerezza: le tubazioni sono molto più leggere rispetto ai tubi metallici
- Igiene: i materiali utilizzati sono atossici e certificati per il trasporto di acqua potabile
- Igienicità, assenza di incrostazioni e funghi (l'estrema levigatezza della superficie interna riduce la possibilità di ostruzioni causate da crescita di incrostazioni e funghi)
- Perdite di carico ridotte: la superficie interna liscia e levigata riduce le perdite di carico ed evita la formazione di incrostazioni
- Flessibilità: la presenza dell'alluminio ad alto grado di snervamento consente di modellare il tubo con estrema facilità
- Ideale per zone sismiche grazie alla flessibilità e capacità di attenuazione delle vibrazioni
- Resistenza chimica ed elettrochimica (essendo il PEX un cattivo conduttore elettrico non è soggetto a fenomeni distruttivi delle correnti vaganti)
- Barriera all'ossigeno: lo strato di alluminio saldato testa/testa costituisce una barriera all'ossigeno che favorisce la formazione di alghe, funghi e corrosione

ADVANTAGES

- *Excellent sound insulation: the elasticity of the cross-linked polyethylene allows for excellent absorption of vibrations*
- *Corrosion resistance*
- *Lightness: pipes are much lighter than metal pipes*
- *Hygiene: the materials used are non-toxic and certified for the transport of drinking water*
- *Hygiene, absence of encrustations and fungi (the extreme smoothness of the internal surface reduces the possibility of obstructions caused by the growth of encrustations and fungi)*
- *Reduced pressure drops: the smooth and polished internal surface reduces pressure drops and avoids the formation of encrustations*
- *Flexibility: the presence of aluminum with a high degree of yield allows the tube to be modeled very easily*
- *Ideal for seismic areas thanks to its flexibility and ability to attenuate vibrations*
- *Chemical and electrochemical resistance (PEX being a bad electrical conductor it is not subject to destructive phenomena of stray currents)*
- *Barrier to oxygen: the butt-welded aluminum layer forms an oxygen barrier that promotes the formation of algae, fungi and corrosion*

COMPOSIZIONE DEL TUBO PIPE COMPOSITION



COMPOSIZIONE STRATI LAYER COMPOSITION

Un tubo interno in polietilene reticolato (PEX)
A cross-linked polyethylene (PEX) inner pipe

Uno strato di collante di elevata qualità per poter garantire un collegamento omogeneo tra il tubo in alluminio e il tubo interno in PEX
A layer of high quality glue to ensure a homogeneous connection between the aluminum pipe and the internal PE-X pipe

Un tubo in alluminio, saldato in senso longitudinale e controllato elettronicamente
An aluminum tube, longitudinally welded and electronically controlled

Uno strato di collante di elevata qualità per poter garantire un collegamento omogeneo tra il tubo in alluminio e il tubo esterno in PEX
A layer of high quality glue to ensure a homogeneous connection between the aluminum pipe and the external PEX pipe

Un tubo esterno in polietilene reticolato (PEX)
A cross-linked polyethylene (PEX) outer pipe

POLIETILENE RETICOLATO (PEX)

Il polietilene è un materiale polimerico termoplastico composto da numerose molecole lunghe che, anche a temperature moderatamente elevate (ancora sotto il punto di fusione), comincia ad avere un significativo grado di fluidità.

CROSS-LINKED POLYETHYLENE (PEX)

Polyethylene is a thermoplastic polymeric material composed of numerous long molecules that, even at moderately high temperatures (still below the melting point), begins to have a significant degree of fluidity. With the cross-linking process, the polyethylene molecules

Con il processo di reticolazione le molecole di polietilene si legano insieme per formare una struttura tridimensionale più complessa: la reazione chimica di reticolazione trasforma infatti il prodotto da termoplastico a termoindurente.

Il materiale subisce una modificazione strutturale che ne migliora le caratteristiche quali l'abrasione, la resistenza chimica, la resistenza meccanica nel tempo, la resistenza all'invecchiamento e alle alte temperature. Le prestazioni meccaniche del materiale vengono incrementate significativamente.

Il polietilene reticolato può essere prodotto mediante tecnologie diverse riconosciute dalle norme internazionali e identificate con i metodi A (perossidi), B (silani), C (radiazioni). Il metodo utilizzato viene indicato dopo la sigla del materiale ottenendo rispettivamente PE-Xa, PE-Xb, PE-Xc.

Tutti i metodi sopracitati valgono: non è il processo di reticolazione che definisce la bontà del prodotto, bensì la sua capacità di superare i test fisici e meccanici definiti dalle norme.

are bonded together to form a more complex three-dimensional structure: the chemical cross-linking reaction transforms the product from thermoplastic to thermosetting.

The material undergoes a structural modification that improves its characteristics such as abrasion, chemical resistance, mechanical resistance over time, resistance to ageing and high temperatures. The mechanical performance of the material is significantly increased. Cross-linked polyethylene can be produced by different technologies recognised by international standards and identified by methods A (peroxides), B (silanes), and C (radiation). The method used is indicated after the abbreviation of the material: PE-Xa, PE-Xb, PE-Xc.

All the above methods are valid: it is not the cross-linking process that defines the quality of the product, but its ability to pass the physical and mechanical tests defined by the standards.

PERMEABILITA' ALL'OSSIGENO

Il tubo di General Fittings risulta impermeabile a qualsiasi fenomeno di diffusione, in quanto la struttura intermedia in alluminio garantisce un passaggio nullo dei gas all'interno del tubo stesso.

Tale caratteristica lo rende la soluzione perfetta in ogni impianto di riscaldamento che preveda scambiatori in alluminio o fasci tubieri metallici sensibili alla diffusione dell'ossigeno.

Le tubazioni multistrato di General Fittings possono inoltre essere utilizzate in impianti di riscaldamento a pavimento in conformità a quanto previsto dalla normativa UNI EN1264 che prescrive barriera anti-diffusione dell'ossigeno sulle tubazioni per impianti radianti limitandone a 0,32 mg/m² al giorno allo scopo di evitare la riduzione della vita utile della tubazione stessa.

PERMEABILITY TO OXYGEN

General Fittings pipe is impermeable to any diffusion phenomenon, as the intermediate aluminum structure guarantees a zero passage of gases inside the tube itself. This feature makes it the perfect solution in any heating system that includes aluminum exchangers or metal tube bundles sensitive to oxygen diffusion.

General Fittings multilayer pipes can also be used in underfloor heating systems in compliance with the provisions of the UNI EN1264 standard which prescribes an oxygen diffusion barrier on the pipes for radiant floor heat systems, limiting it to 0.32 mg / m² per day in order to avoid the reduction of the useful life of the pipe itself.

PRIMER ADESIVANTE

Il nastro di alluminio è fissato agli strati interno ed esterno in PEX mediante due strati di colla.

Quest'ultima è stata specificatamente sviluppata per massimizzare l'adesione fra PEX ed alluminio e per fare in modo che la forza di incollaggio non decada con il tempo e con temperature elevate.

Grazie all'adesivo i due strati di PEX e lo strato di alluminio vanno a costituire un tutt'uno con proprietà superiori rispetto al singolo componente.

ADHESIVE PRIMER

The aluminum tape is attached to the inner and outer PEX layers by two layers of glue.



The latter was specifically developed to maximize the adhesion between PEX and aluminum and to ensure that the bond strength does not decline with time and with high temperatures.

Thanks to the adhesive, the two layers of PEX and the aluminum layer form a whole with superior properties compared to the single component.

CLASSI D'APPLICAZIONE APPLICATION CLASSES

Classe Class	Temperatura Design Temperature	TIMEb at TD	T max	Tempo a T max Time at T max	T mal	Tempo a T mal Time at T mal	Campi di applicazione Typical Field of application
1a	60	49	80	1	95	100	Acqua calda sanitaria (60 °C) Hot water supply (60 °C)
2a	70	49	80	1	95	100	Acqua calda sanitaria (70 °C) Hot water supply (70 °C)
4b	20 plus cumulative	2.5	70	2.5	100		Riscaldamento a pavimento e radiatori a bassa temperatura Underfloor heating and low temperatures radiators
4b	40 plus cumulative	20	70	2.5	100		Riscaldamento a pavimento e radiatori a bassa temperatura Underfloor heating and low temperatures radiators
4b	60	25	70	2.5	100		Riscaldamento a pavimento e radiatori a bassa temperatura Underfloor heating and low temperatures radiators
5b	20 plus cumulative	14	90	1	100		Riscaldamento a pavimento e radiatori a bassa temperatura High temperatures radiators
5b	60 plus cumulative	25	90	1	100		Riscaldamento a pavimento e radiatori a bassa temperatura High temperatures radiators
5b	80	10	90	1	100		Riscaldamento a pavimento e radiatori a bassa temperatura High temperatures radiators

**TB00.20
SYLVER**TUBO MULTISTRATO SYLVER PE-Xc/Al/PE-Xc
PE-Xc/Al/PE-Xc MULTILAYER PIPE SYLVER

CODICE	Ø		
TB0020G162210S	16x2.2	100 m	1800 m
TB0020G202810S	20x2.8	100 m	1200 m
TB0020G253510S	25x3.5	100 m	1200 m
TB0020G324450S	32x4.4	50 m	350 m

Disponibile a richiesta

Available on demand

TB00.20.ATUBO MULTISTRATO PE-Xc/Al/PE-Xc RIVESTITO
AZZURRO
PE-Xc/Al/PE-Xc MULTILAYER PIPE WITH LIGHT BLUE
INSULATION

CODICE	i	Ø	
TB0020A162206S	6 mm	16x2.2	50 m
TB0020A202806S	6 mm	20x2.8	50 m
TB0020A253510S	10 mm	25x3.5	50 m
TB0020A324413S	13 mm	32x4.4	25 m

RACCORDI PER
TUBO
POLIETILENE
FITTINGS FOR
POLYETHYLENE
PIPE

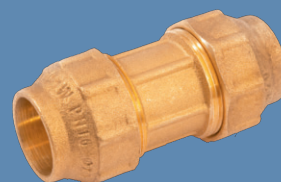



KRATOS

SERIE 4500

LINE 4500



Raccordi a compressione con ghiera femmina

Compression fittings with female nut

I raccordi a compressione della serie 4500 sono utilizzabili per la distribuzione di acqua potabile, in impianti sanitari, di irrigazione (PEBD), di convogliamento e distribuzione di gas combustibili (PEBD / PEAD). Possono inoltre essere utilizzati in ogni tipo di installazione idraulica (commerciale, civile, industriale ed agricola) e in linea di massima con fluidi non aggressivi.

Compression fittings with female nut for Polyethylene pipe [LINE 4500] are suitable for the supply of drinking water, for irrigation installation (PEBD), sanitary systems and in the gas fuels conveying and distribution (LDPE-PEHD). They are also suitable for any kind of sanitary installation such as domestic, commercial, industry and farming and with any type of non-corrosive fluid.



VANTAGGI

- Completezza della gamma
- Utilizzabile per acqua sanitaria e gas
- Installazione semplice e rapida
- Materie prime impiegate di alta qualità [UBA LIST]

ADVANTAGES

- Complete range
- Suitable both for drinking water and gas
- Quick and easy installation
- Raw materials complying with UBA LIST

CAMPI DI APPLICAZIONI E PRESTAZIONI FIELDS OF APPLICATION

APPLICAZIONI APPLICATIONS	T. min.	T. max	T. di sistema T. of the system	Press.max Max. pressure
 acqua potabile drinking water	-20°C	+80°C	-20°C/+40°C	16 bar
 irrigazione irrigation	-20°C	+80°C	-20°C/+40°C	16 bar
 gas gas	-20°C	+40°C	-20°C/+40°C	10 bar

Sistema tubo + raccordo con temperatura di lavoro di riferimento 20°C:
 PE80-12,5 bar acqua
 PE100-16 bar acqua
 PE80- 4bar gas
 PE100- 10 bar gas
 per temperature superiori ai 20°C fino a 40°C (uso acqua)
 utilizzare i seguenti fattori di riduzione della pressione:
 30°C moltiplicare per 0,87
 40°C moltiplicare per 0,74





Pipe + fitting system with reference working temperature 20 °C
PE80-12,5 bar water
PE100-16 bar water
PE80-4 bar gas
PE100-10 bar gas
for temperatures from 20 °C up to 40 °C (for water application), use the following pressure reduction factors:
30°C multiply by 0,87
40°C multiply by 0,74

COPPIE DI SERRAGGIO CLOSING COUPLES

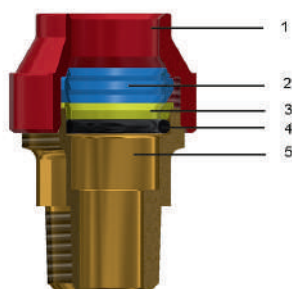
∅	Coppia (Nm) Torque (Nm)
∅20	25
∅25	34
∅32	44
∅40	55
∅50	60
∅63	130

COMPONENTI E MATERIALI COMPONENTS AND MATERIALS



LEGENDA LEGEND	COMPONENTI COMPONENTS	MATERIALI MATERIALS
	1 Dado Nut	Ottone CW617N - UNI EN 12165 Brass CW617N - UNI EN 12165
	2 Ogiva Olive	Ottone CW617N - UNI EN 12164 Brass CW617N - UNI EN 12164
	3 Rondella Flat ring	Ottone CW617N - UNI EN 12164 Brass CW617N - UNI EN 12164
	4 O-Ring	Elastomero per acqua potabile (ad eccezione della Germania) Elastomer for drinking water (except for Germany)
	5 Corpo Body	Ottone CW617N - UNI EN 12165 Brass CW617N - UNI EN 12165

TUBI COMPATIBILI

I raccordi della serie 4500 sono utilizzabili con tubi in polietilene.

SUITABLE PIPES

Polyethylene pipes.

NORMATIVE

- UNI EN 12201-3
I raccordi sono conformi alla norma UNI EN 12201-3 "Sistemi di tubazioni di materia plastica per la distribuzione dell'acqua"
- UNI EN 10226-1
Tutte le filettature sono conformi alla norma UNI EN 10226-1: " Filettatura di tubazioni per accoppiamento a tenuta sul filetto"
- D.M. 174 (06/04/2004)
I materiali utilizzati sono conformi al Decreto Ministeriale n° 174 del 06/04/2004 [Regolamento concernente i materiali e gli oggetti che possono essere utilizzati negli impianti fissi di captazione, trattamento, adduzione e distribuzione delle acque destinate al consumo umano]
- UNI EN 1254-3
I raccordi sono conformi alla norma UNI EN 1254-3: "Raccorderia idraulica per tubazioni di plastica con terminali a compressione"
- Conforme a 4MS, UBA List (gruppo BC), DIN 50930/6 Dir. 2011/65/UE, 6C allegato III (RhOSII)
- Conformi a DVGW DW335-B4 (P)
- Conformi a DVGW G5600-1 (P)

REGULATIONS

- UNI EN 12201-3
Fittings comply with UNI EN 12201-3 law: "Plastic piping systems for water supply".
- UNI EN 10226-1
Threads comply with UNI EN 10226-1 law: "Piping thread for coupling on the thread".
- D.M. 174 (06/04/2004)
Raw materials used are of high quality and comply with the Ministerial Decree N°174 dated 06/04/2004 concerning the materials and the items used in fixed installations for water collection, treatment and supply.
- UNI EN 1254-3
Fittings comply with UNI EN 1254-3 law: "Sanitary fittings for plastic pipes with compression ends".
- Comply with 4MS, UBA List (BC group), DIN 50930/6 Dir. 2011/65/UE, 6C attachment III (RhOSII)
- Comply with DVGW DW335-B4 (P)
- Comply DVGW G5600-1 (P)

CERTIFICAZIONI CERTIFICATIONS

STATO COUNTRY	CERTIFICAZIONE CERTIFICATION	STATO COUNTRY	CERTIFICAZIONE CERTIFICATION	STATO COUNTRY	CERTIFICAZIONE CERTIFICATION
					
					
					

ISTRUZIONI DI MONTAGGIO ASSEMBLY INSTRUCTIONS

Utilizzando un apposito utensile taglia tubi [codice TT50.00] o un seghetto a denti fini segnare il tubo ed eseguire un taglio perpendicolare all'asse del tubo. Il tubo deve essere segnato così che, inserito nel corpo (prima dell'avvitamento del dado), possa assestarsi sul fondo della propria sede. Ricordarsi di sbavare il tubo onde evitare danneggiamenti all'O-Ring ed eliminare eventuale bava residua.

Mark and cut the pipe perpendicularly to its axis using an appropriate pipe-cutting tool [code TT50.00] or a saw with fine springs. The pipe has to be marked in order to let it sort out at the end of its seat once inserted in the fitting and before screwing the nut. The pipe has to be fettled to avoid O-Ring damages. Remove possible residual burr.

Inserire i componenti sul tubo nella sequenza di seguito indicata: dado, ogiva tagliata (i riferimenti sulla superficie esterna devono essere rivolti verso il dado), anello di compressione e guarnizione (e infine la bussola dove prevista).

Insert the components on the pipe according to sequence that follows: nut, cut olive (external surface marks have to be directed forward the nut and not forward the fitting), compression ring and gasket (and at the end the sleeve, where expected)

Posizionare il tubo e i componenti nel corpo raccordo bloccando manualmente il sistema con l'avvitamento del dado. Serrare il dado con chiave fissa o attrezzatura idonea imprimendo una coppia di avvitamento come in tabella [pag. precedente].

Place the pipe and the components in the fitting, blocking manually the system with the nut screwing. Close the nut using a fixed spanner or a suitable tool giving a screwing coupling as shown in the table [previous page]



Si consiglia sempre di verificare la chiusura del dado dopo un periodo di assestamento della guarnizione e del tubo [circa 24h].

N.B. Qualora i raccordi venissero utilizzati per impianti a Gas, prima dell'inserimento del tubo nel raccordo, deve essere posizionata l'apposita bussola di rinforzo (fornita solo su richiesta del cliente).

It's suggested to check the nut closing after a seal and pipe adjustment period [24h].

N.B. if the fittings are used for gas application, before installing the pipe in the fitting, remember to position the appropriate reinforcement part (supplied only on customer request).

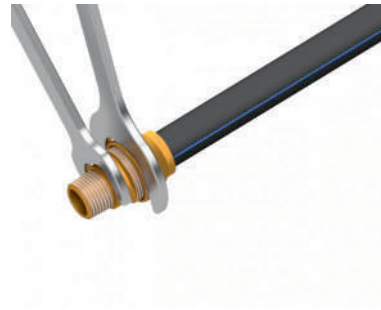

4500.00RACCORDO DIRITTO DOPPIO
DOUBLE STRAIGHT FITTING

CODICE	Ø	◇	☐
450000H202000Y	20x20	10	40
450000H252500Y	25x25	10	20
450000H323200Y	32x32	5	15
450000H404000Y	40x40	-	12
450000H505000Y	50x50	-	8
450000H636300Y	63x63	-	3

4500.01RACCORDO DIRITTO MASCHIO
MALE STRAIGHT FITTING

CODICE	Ø	◇	☐
450001H042000Y	1/2"x20	10	60
450001H052500Y	3/4"x25	10	40
450001H103200Y	1"x32	5	30
450001H124000Y	1"1/4x40	-	20
450001H145000Y	1"1/2x50	-	10
450001H206300Y	2"x63	-	6

4500.02RACCORDO DIRITTO FEMMINA
FEMALE STRAIGHT FITTING

CODICE	Ø	◇	☐
450002H042000Y	1/2"x20	10	60
450002H052500Y	3/4"x25	10	40
450002H103200Y	1"x32	5	20
450002H124000Y	1"1/4x40	-	20
450002H145000Y	1"1/2x50	-	10
450002H206300Y	2"x63	-	6

4500.10RACCORDO A T
TEE

CODICE	Ø	◇	☐
450010H202020Y	20x20x20	10	30
450010H252525Y	25x25x25	5	15
450010H323232Y	32x32x32	-	10
450010H404040Y	40x40x40	-	6
450010H505050Y	50x50x50	-	4
450010H636363Y	63x63x63	-	2

4500.11 RACCORDO A T MASCHIO
MALE TEE

CODICE	Ø	◇	☐
450011H200420Y	1/2"x20	10	30
450011H250525Y	3/4"x25	5	20
450011H321032Y	1"x32	-	15
450011H401240Y	1"1/4x40	-	6
450011H501450Y	1"1/2x50	-	4
450011H632063Y	2"x63	-	3

4500.20 ANGOLO DOPPIO
DOUBLE ELBOW

CODICE	Ø	◇	☐
450020H202000Y	20x20	10	40
450020H252500Y	25x25	10	20
450020H323200Y	32x32	-	15
450020H404000Y	40x40	-	10
450020H505000Y	50x50	-	5
450020H636300Y	63x63	-	3

4500.12 RACCORDO A T FEMMINA
FEMALE TEE

CODICE	Ø	◇	☐
450012H200420Y	1/2"x20	10	30
450012H250525Y	3/4"x25	5	20
450012H321032Y	1"x32	-	15
450012H401240Y	1"1/4x40	-	6
450012H501450Y	1"1/2x50	-	4
450012H632063Y	2"x63	-	3

4500.21 ANGOLO MASCHIO
MALE ELBOW

CODICE	Ø	◇	☐
450021H042000Y	1/2"x20	10	60
450021H052500Y	3/4"x25	10	30
450021H103200Y	1"x32	-	25
450021H124000Y	1"1/4x40	-	10
450021H145000Y	1"1/2x50	-	6
450021H206300Y	2"x63	-	3

4500.22 ANGOLO FEMMINA
FEMALE ELBOW



CODICE	Ø	◇	☐
450022H042000Y	1/2"x20	10	60
450022H052500Y	3/4"x25	10	30
450022H103200Y	1"x32	-	25
450022H124000Y	1"1/4x40	-	10
450022H145000Y	1"1/2x50	-	6
450022H206300Y	2"x63	-	3

4500.23 ANGOLO CON FLANGIA 3 FORI
WALLPLATE ELBOW WITH 3 HOLES



CODICE	Ø	◇	☐
450023H042000Y	1/2"x20	10	30
450023H052500Y	3/4"x25	5	20
450023H103200Y	1"x32	-	15

4500.43 RACCORDO DIRITTO DOPPIO PROLUNGATO
LONG DOUBLE STRAIGHT FITTING



CODICE	Ø	☐
450043H323200Y	32	15
450043H404000Y	40	10
450043H505000Y	50	5
450043H636300Y	63	3

4800.94 BUSSOLA DI RINFORZO-per tubo SDR11
REINFORCING BUSHING-for SDR11 pipe



CODICE	i	Ø	◇	☐
480094H200000H	Acqua	20	10	250
480094H2000G1H	Gas	20	10	250
480094H250000H	Acqua	25	10	150
480094H2500G1H	Gas	25	10	150
480094H320000H	Acqua/Gas	32	10	100
480094H400000H	Acqua/Gas	40	5	50
480094H500000H	Acqua/Gas	50	-	40
480094H630000H	Acqua/Gas	63	-	20

4800.94

BUSSOLA DI RINFORZO-per tubo SDR17.6
REINFORCING BUSHING-for SDR17.6 pipe



CODICE	i	Ø	◇	☐
480094H320001H	Acqua/Gas	32	10	100
480094H400001H	Acqua/Gas	40	5	50
480094H500001H	Acqua/Gas	50	-	30
480094H630001H	Acqua/Gas	63	-	20
480094H750001H	Acqua/Gas	75	-	-

4500.70

GHIERA DI RICAMBIO
REPLACEMENT RING NUT



CODICE	Ø	☐
450070H200000Y	20	-
450070H250000Y	25	120
450070H320000Y	32	70
450070H400000Y	40	40
450070H500000Y	50	-
450070H630000Y	63	-

4500.81

ANELLO TAGLIATO
BRASS CUT RING



CODICE	Ø	☐
450081R200000H	20	-
450081R250000H	25	-
450081R320000H	32	-
450081R400000H	40	150
450081R500000H	50	-
450081R630000H	63	-

4500.82

RONDELLA
RING



CODICE	Ø	☐
450082H200000H	20	-
450082H250000H	25	1000
450082H320000H	32	500
450082H400000H	40	300
450082H500000H	50	-
450082H630000H	63	-

OR00.14 O-RING NBR (standard)
O-RING NBR (STANDARD)



CODICE	Ø
OR0014H202600H	20
OR0014H253500H	25
OR0014H313500H	32
OR0014H404000H	40
OR0014H505300H	50
OR0014H625300H	63

Certificato per acqua e gas

Certified for gas and water

OR00.21 O-RING EPDM PEROX (optional)
O-RING EPDM PEROX (OPTIONAL)



CODICE	Ø
OR0021H202600H	20
OR0021H253500H	25
OR0021H313500H	32
OR0021H404000H	40
OR0021H505300H	50
OR0021H625300H	63

Certificato per acqua (Germania)

Certified for water (Germany)



COSMOS

SERIE 4800

LINE 4800



Raccordi a compressione con ghiera maschio

Compression fittings with male nut

I raccordi a compressione della serie 4800 sono utilizzabili per la distribuzione di acqua potabile, in impianti sanitari, impianti di irrigazione (PEBD), in ogni tipo di installazione idraulica (commerciale, civile, industriale ed agricola) e in linea di massima con fluidi non aggressivi.

Compression fittings with male nut for Polyethylene pipe [LINE 4800] are suitable for supply of drinkable water, for irrigation installation (LDPE), for sanitary systems and for any kind of sanitary installation such as domestic, commercial, industry and farming and with any type of non-corrosive fluid.

FITTINGS FOR
POLYETHYLENE PIPE



VANTAGGI

- Completezza della gamma
- Utilizzabili per acqua potabile
- Installazione semplice e rapida
- Materie prime impiegate di alta qualità [UBA LIST]

ADVANTAGES

- Complete range
- Suitable for drinking water
- Quick and easy installation
- Raw materials complying with UBA LIST

CAMPI DI APPLICAZIONI E PRESTAZIONI FIELDS OF APPLICATION

APPLICAZIONI APPLICATIONS		T. min.	T. max	T. di sistema T. of the system	Press.max Max. pressure
	acqua potabile drinking water	-20°C	+80°C	-20°C/+40°C	16 bar
	irrigazione irrigation	-20°C	+80°C	-20°C/+40°C	16 bar

TUBI COMPATIBILI

SUITABLE PIPES

Tubi in polietilene.

Polyethylene pipes.

COPPIE DI SERRAGGIO CLOSING COUPLES

Ø	Coppia (Nm) Torque (Nm)
Ø 20	23
Ø 25	32
Ø 32	38
Ø 40	43
Ø 50	60
Ø 63	130

COMPONENTI E MATERIALI COMPONENTS AND MATERIALS

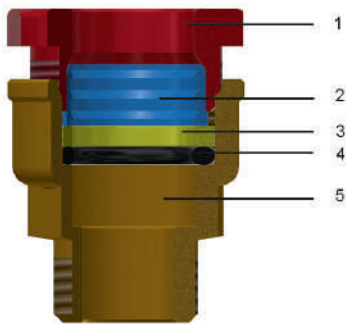

LEGENDA LEGEND	COMPONENTI COMPONENTS	MATERIALI MATERIALS
	1 Ghiera Closing ring	Ottone CW617N - UNI EN 12165 Brass CW617N - UNI EN 12165
	2 Ogiva tagliata Cut olive	Ottone CW617N - UNI EN 12164 Brass CW617N - UNI EN 12164
	3 Rondella Flat ring	Ottone CW617N - UNI EN 12164 Brass CW617N - UNI EN 12164
	5 Corpo Body	Ottone CW617N - UNI EN 12165 Brass CW617N - UNI EN 12165
	4 O-Ring	Elastomero per acqua potabile (ad eccezione della Germania) Elastomer for drinking water (except for Germany)

















NORMATIVE

- UNI EN 12201-3
I raccordi sono conformi alla norma UNI EN 12201-3 "Sistemi di tubazioni di materia plastica per la distribuzione dell'acqua".
- UNI EN ISO 228-1:2003
Tutte le filettature sono conformi alla norma UNI EN ISO 228-1:2003: " Filettatura di tubazioni per accoppiamento non a tenuta sul filetto".
- D.M. 174 (06/04/2004)
I materiali utilizzati sono conformi al Decreto Ministeriale n° 174 del 06/04/2004 [Regolamento concernente i materiali e gli oggetti che possono essere utilizzati negli impianti fissi di captazione, trattamento, adduzione e distribuzione delle acque destinate al consumo umano].
- UNI EN 1254-3
I raccordi sono conformi alla norma UNI EN 1254-3: "Raccorderia idraulica per tubazioni di plastica con terminali a compressione".
- Conforme a 4MS, UBA List (gruppo BC), DIN 50930/6 Dir. 2011/65/UE, 6C allegato III (RhOSII)
- Conformi a DVGW DW335-B4 (P)

REGULATIONS

- UNI EN 12201-3
Fittings comply with UNI EN 12201-3 law: "Plastic piping systems for water supply".
- UNI EN ISO 228-1:2003
Threads complies with UNI EN ISO 228-1:2003 law: "Piping thread for coupling not with tightness on the thread".
- D.M. 174 (06/04/2004)
Raw materials used are of high quality and comply with the Ministerial Decree N°174 dated 06/04/2004 concerning the materials and the items used in fixed installations for water collection, treatment and supply.
- UNI EN 1254-3
Fittings comply with UNI EN 1254-3 law: "Sanitary fittings for plastic pipes with compression ends".
- Comply with 4MS, UBA List (BC group), DIN 50930/6 Dir. 2011/65/UE, 6C attachment III (RhOSII).
- Comply with DVGW DW335-B4 (P)

CERTIFICAZIONI CERTIFICATIONS

STATO COUNTRY	CERTIFICAZIONE CERTIFICATION	STATO COUNTRY	CERTIFICAZIONE CERTIFICATION	STATO COUNTRY	CERTIFICAZIONE CERTIFICATION
					
					
					
					

ISTRUZIONI DI MONTAGGIO ASSEMBLY INSTRUCTIONS

Utilizzando un apposito utensile taglia tubi [codice TT50.00] o un seghetto a denti fini segnare il tubo ed eseguire un taglio perpendicolare all'asse del tubo. Il tubo deve essere segnato così che, inserito nel corpo (prima dell'avvitamento del dado), possa assestarsi sul fondo della propria sede. Ricordarsi di sbavare il tubo onde evitare danneggiamenti all'O-Ring ed eliminare eventuale bava residua.

Mark and cut the pipe perpendicularly to its axis using an appropriate pipe-cutting tool [code TT50.00] or a saw with fine springs. The pipe has to be marked in order to let it sort out at the end of its seat once inserted in the fitting and before screwing the nut. The pipe has to be fettled to avoid O-Ring damages. Remove possible residual burr.

Inserire i componenti sul tubo nella sequenza di seguito indicata: ghiera, ogiva tagliata (lo smusso esterno deve essere rivolto verso la ghiera), anello di compressione e guarnizione (ed infine la bussola dove prevista).

Insert the components on the pipe according to sequence that follows: nut, cut olive (external surface marks have to be directed forward the nut and not forward the fitting), compression ring and gasket (and at the end the sleeve, where expected).

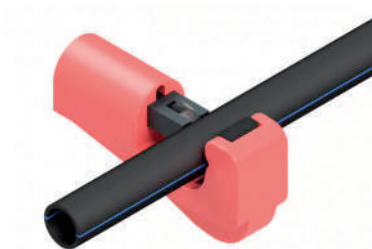

Posizionare il tubo e i componenti nel corpo raccordo bloccando manualmente il sistema con l'avvitamento del dado. Serrare il dado con chiave fissa o attrezzatura idonea imprimendo una coppia di avvitamento come in tabella [pag. precedente].

Place the pipe and the components in the fitting, blocking manually the system with the nut screwing. Close the nut using a fixed spanner or a suitable tool giving a screwing coupling as shown in the table [previous page]

Si consiglia sempre di verificare la chiusura del dado dopo un periodo di assestamento della guarnizione e del tubo [circa 24h].

It's suggested to check the nut closing after a seal and pipe adjustment period [24h].

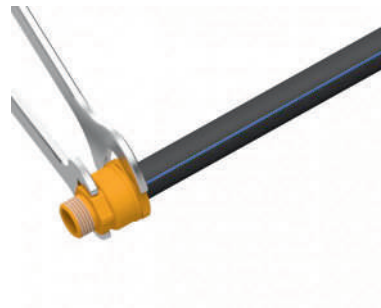
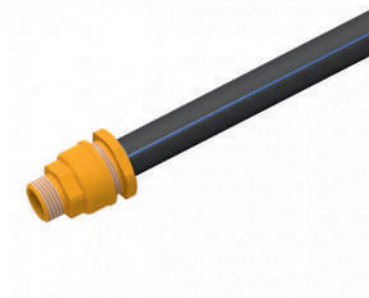

4800.00RACCORDO DIRITTO DOPPIO
DOUBLE STRAIGHT FITTING

CODICE	Ø	◇	📦
480000H202000A	20x20	10	40
480000H252500A	25x25	10	30
480000H323200A	32x32	5	20
480000H404000A	40x40	-	15
480000H505000A	50x50	-	9
480000H636300A	63x63	-	4

4800.00.YRACCORDO DIRITTO DOPPIO
DOUBLE STRAIGHT FITTING

CODICE	Ø	📦
480000H757500Y	75x75	4
480000H909000Y	90x90	4
480000HB1B100Y	110x110	2

4800.01RACCORDO DIRITTO MASCHIO
MALE STRAIGHT FITTING

CODICE	Ø	◇	📦
480001H042000A	1/2"x20	10	70
480001H052500A	3/4"x25	10	50
480001H103200A	1"x32	5	30
480001H124000A	1"1/4x40	-	20
480001H145000A	1"1/2x50	-	10
480001H206300A	2"x63	-	6

4800.01.YRACCORDO DIRITTO MASCHIO
MALE STRAIGHT FITTING

CODICE	Ø	📦
480001H247500Y	2"1/2x75	6
480001H309000Y	3"x90	5
480001H40B100Y	4"x110	3

4800.02 RACCORDO DIRITTO FEMMINA
FEMALE STRAIGHT FITTING

CODICE	Ø	◇	📦
480002H042000A	1/2"x20	10	70
480002H052500A	3/4"x25	10	50
480002H103200A	1"x32	5	30
480002H124000A	1"1/4x40	-	20
480002H145000A	1"1/2x50	-	10
480002H206300A	2"x63	-	6

4800.02.Y RACCORDO DIRITTO FEMMINA
FEMALE STRAIGHT FITTING

CODICE	Ø	📦
480002H247500Y	2"1/2x75	6
480002H309000Y	3"x90	5
480002H40B100Y	4"x110	3

4800.10 RACCORDO A T
TEE

CODICE	Ø	◇	📦
480010H202020A	20x20x20	10	20
480010H252525A	25x25x25	5	15
480010H323232A	32x32x32	-	10
480010H404040A	40x40x40	-	8
480010H505050A	50x50x50	-	4
480010H636363A	63x63x63	-	2

4800.10.Y RACCORDO A T
TEE

CODICE	Ø	📦
480010H757575Y	75x75x75	2
480010H909090Y	90x90x90	-
480010HB1B1B1Y	110x110x110	-

4800.11 RACCORDO A T MASCHIO
MALE TEE



CODICE	Ø	◇	📦
480011H200420A	20x1/2"x20	10	30
480011H250525A	25x3/4"x25	5	20
480011H321032A	32x1"x32	-	12
480011H401240A	40x1"1/4x40	-	8
480011H501450A	50x1"1/2x50	-	4
480011H632063A	63x2"x63	-	3

4800.12 RACCORDO A T FEMMINA
FEMALE TEE



CODICE	Ø	◇	📦
480012H200420A	20x1/2"x20	10	30
480012H250525A	25x3/4"x25	5	20
480012H321032A	32x1"x32	-	15
480012H401240A	40x1"1/4x40	-	8
480012H501450A	50x1"1/2x50	-	4
480012H632063A	63x2"x63	-	3

4800.12.Y RACCORDO A T FEMMINA
FEMALE TEE



CODICE	Ø	📦
480012H752475Y	75x2"1/2x75	2
480012H903090Y	90x3"x90	-
480012HB140B1Y	110x4"x110	-

4800.13 RACCORDO A T RIDOTTO
REDUCED TEE



CODICE	Ø	📦
480013H402540A	40 x 25 (2,3) x 40	8

4800.20 ANGOLO DOPPIO
DOUBLE ELBOW

CODICE	Ø	◇	📦
480020H202000A	20x20	10	40
480020H252500A	25x25	5	20
480020H323200A	32x32	-	15
480020H404000A	40x40	-	8
480020H505000A	50x50	-	4
480020H636300A	63x63	-	3

4800.20.Y ANGOLO DOPPIO
DOUBLE ELBOW

CODICE	Ø	📦
480020H757500Y	75x75	3
480020H909000Y	90x90	-
480020HB1B100Y	110x110	-

4800.21 ANGOLO MASCHIO
MALE ELBOW

CODICE	Ø	◇	📦
480021H042000A	1/2"x20	10	50
480021H052500A	3/4"x25	10	40
480021H103200A	1"x32	-	20
480021H124000A	1"1/4x40	-	12
480021H145000A	1"1/2x50	-	9
480021H206300A	2"x63	-	4

4800.21.Y ANGOLO MASCHIO
MALE ELBOW

CODICE	Ø	📦
480021H247500Y	2"1/2x75	4
480021H309000Y	3"x90	2
480021H40B100Y	4"x110	-

4800.22 ANGOLO FEMMINA
FEMALE ELBOW



CODICE	Ø	◇	📦
480022H042000A	1/2"x20	10	50
480022H052500A	3/4"x25	10	40
480022H103200A	1"x32	-	20
480022H124000A	1"1/4x40	-	15
480022H145000A	1"1/2x50	-	10
480022H206300A	2"x63	-	4

4800.22.Y ANGOLO FEMMINA
FEMALE ELBOW



CODICE	Ø	📦
480022H247500Y	2"1/2x75	4
480022H309000Y	3"x90	2
480022H40B100Y	4"x110	-

4800.23 ANGOLO CON FLANGIA 3 FORI
WALLPLATE ELBOW WITH 3 HOLES



CODICE	Ø	◇	📦
480023H042000A	1/2"x20	10	40
480023H052500A	3/4"x25	5	20

4800.94 BUSSOLA DI RINFORZO-per tubo SDR11
REINFORCING BUSHING-for SDR11 pipe



CODICE	i	Ø	◇	📦
480094H200000H	Acqua	20	10	250
480094H250000H	Acqua	25	10	150
480094H320000H	Acqua	32	10	100
480094H400000H	Acqua	40	5	50
480094H500000H	Acqua	50	-	40
480094H630000H	Acqua	63	-	20

4800.94 BUSSOLA DI RINFORZO-per tubo SDR17.6
REINFORCING BUSHING-for SDR17.6 pipe



CODICE	i	Ø	◇	☐
480094H320001H	Acqua	32	10	100
480094H400001H	Acqua	40	5	50
480094H500001H	Acqua	50	-	30
480094H630001H	Acqua	63	-	20
480094H750001H	Acqua	75	-	-

4800.70 GHIERA
RING NUT



CODICE	Ø	☐
480070H200000A	20	-
480070H250000A	25	-
480070H320000A	32	120
480070H400000A	40	-
480070H500000A	50	-
480070H630000A	63	-

4800.81 OGIVA TAGLIATA
CUT OLIVE



CODICE	Ø	☐
480081R200000H	20	-
480081R250000H	25	-
480081R320000H	32	400
480081R400000H	40	-
480081R500000H	50	-
480081R630000H	63	-

4800.82 RONDELLA PIANA
FLAT RING



CODICE	Ø	☐
480082H200000H	20	-
480082H250000H	25	-
480082H320000H	32	1250
480082H400000H	40	-
480082H500000H	50	-
480082H630000H	63	-

OR00.21 O-RING
O-RING



CODICE	Ø	
OR0021H193600H	20	-
OR0021H243600H	25	1000
OR0021H314500H	32	500
OR0021H405300H	40	-
OR0021H506000H	50	-
OR0021H636000H	63	-

SISTEMI PER
TUBO
MULTISTRATO
MULTILAYER
PIPE SYSTEMS





SAFE_PRESS

SERIE 5T00 LINE 5T00



Raccordi a pressare multiprofilo con sistema LBP

Multijaws press fittings with LBP system

I raccordi a pressare per tubo multistrato della serie SAFE_PRESS sono dotati della funzione LEAK BEFORE PRESS (LBP) che consente di visualizzare le perdite di acqua in caso di mancata pressatura. Grazie alla funzione LBP è possibile riconoscere velocemente i punti di mancata pressatura ed intervenire conseguentemente riducendo la possibilità di errore o dimenticanze che possono inficiare la tenuta dell'impianto nel tempo.

I raccordi sono utilizzabili in impianti di adduzione di acqua calda e fredda per usi sanitari o di riscaldamento/raffrescamento, in ogni tipo di installazione idraulica (commerciale, domestica, industriale e agricola) e in linea di massima con fluidi non aggressivi.

La geometria del raccordo consente un ottimo accoppiamento tra tubo e raccordo in seguito alla pressatura e le finestre sul portabussola permettono di verificare la corretta inserzione del tubo. Due O-Ring garantiscono la tenuta e l'affidabilità del prodotto nel tempo.

Il corpo del raccordo è in ottone, mentre la bussola è realizzata in acciaio AISI 304.

Nel caso di installazioni sotto traccia, evitare il contatto tra l'impasto cementizio e le parti metalliche del raccordo. Essendo la tipologia di raccordo irreversibile (non smontabile) è possibile posizionare il raccordo sottotraccia avendo cura di proteggerlo con materiali idonei.

Press fittings for multilayer pipe of line SAFE_PRESS are equipped with LEAK BEFORE PRESS (LBP) system to detect water leak when the fitting is not pressed. This allows the plumber to easily detect the improper installation and eventually react promptly. The "leak before press" function guarantees greater safety and time savings during installation.

Fittings are suitable for cold or hot water supply for sanitary or heating systems, and for any kind of sanitary installation such as domestic, commercial, industry and farming and with non-aggressive fluids.

The geometry of the fitting allows an excellent coupling between pipe and fitting after pressing and the plastic insulation ring windows allow to check the correct insertion of the pipe. Two O-rings guarantee the seal and reliability over time.

Fitting body is made of brass, while the sleeve is made of AISI 304 stainless steel.

Since the connecting type is irreversible (it is not possible to disassemble), it is possible to place the fittings concealed, taking care of protecting it from non-suitable materials.









VANTAGGI

- Funzione LBP (Leak Before Press): massima sicurezza
- Multiprofilo
- Anello dielettrico con finestra di controllo della corretta posizione del tubo
- Doppio O-Ring
- Approvato DVGW, OVGW
- Materie prime impiegate di alta qualità [UBA LIST]
- Filetto conico ISO 7/1
- Installazione efficiente: possibilità di realizzare impianti in serie e ad anello con l'attacco a muro doppio per garantire una migliore distribuzione e ricambio dell'acqua
- Rintracciabilità del prodotto garantita dal datario impresso sul corpo del raccordo

ADVANTAGES

- "Leak Before Press" function for extra safety
- Multitool
- Plastic insulation ring to prevent electrolytic corrosion, and with windows to check the correct insertion of pipe
- Double O-Ring
- DVGW and OVGW certified
- Raw materials complying with UBA LIST
- ISO 7/1 threads
- Efficient installation: double wallplate elbow allows to make installations in series or rings for a better distribution and change of water
- Product traceability guaranteed by the date stamped on the body of the fitting

CAMPI DI APPLICAZIONI E PRESTAZIONI FIELDS OF APPLICATION

APPLICAZIONI APPLICATIONS	T. min.	T. max	T. di sistema T. of the system	Press.max Max. pressure
 acqua potabile drinking water	-20°C	+120°C	-20°C/+95°C	10 bar
 acqua calda sanitaria hot sanitary water	-20°C	+120°C	-20°C/+95°C	10 bar
 raffrescamento cooling	-20°C	+120°C	-20°C/+95°C	10 bar
 radiatori radiators	-20°C	+120°C	-20°C/+95°C	10 bar
 riscaldamento a pavimento floor heating	-20°C	+120°C	-20°C/+95°C	10 bar
 irrigazione irrigation	-20°C	+120°C	-20°C/+95°C	10 bar
 aria compressa compressed air	-20°C	+120°C	-20°C/+95°C	10 bar
 -20°C: solo con liquido antigelo glicole in % max del 30% -20°C: with the use of glycol in a maximum percentage of 30%				

LEAK BEFORE PRESS

LEAK BEFORE PRESS



Il sistema LBP garantisce un'installazione veloce e sicura dei raccordi a pressare in quanto consente la fuoriuscita di liquido laddove la giunzione non sia stata pressata. Quando il raccordo è pressato correttamente l'acqua circola nell'impianto e non si osservano perdite. Se il raccordo invece non è pressato, quando l'acqua circola nell'impianto, si notano le fuoriuscite. Grazie al sistema LBP è quindi possibile riconoscere velocemente i punti di mancata pressatura ed intervenire conseguentemente riducendo la possibilità di errore o dimenticanze che possono inficiare la tenuta dell'impianto nel tempo.

LBP system guarantees a fast and safe installation as if the fitting is not pressed the system shows the water leakage.

When the fitting is pressed correctly, the water circulates in the system and no leaks are observed. If, on the other hand, the fitting is not pressed, leaked water will be visible once it begins circulating in the system.





Thanks to LBP system the non-pressed joints are immediately visible, thus allowing a prompt and timely intervention reducing the possibility of errors or oversights that can affect the tightness of the system over time.

PROFILI DI PINZATURA
PRESSING PROFILES

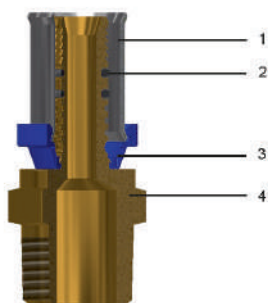
Ø	TH	H	U
16x2.0	TH	H	U
20x2.0	TH	H	U
25x2.5	TH	H	U
26x3.0	TH	H	-
32x3.0	TH	H	U
40x3.5	TH	H	U
50x4.0	TH	H	U
63x4.5	TH	-	U

COMPONENTI E MATERIALI COMPONENTS AND MATERIALS



LEGENDA LEGEND	COMPONENTI COMPONENTS	MATERIALI MATERIALS
	1 Bussola Sleeve	Acciaio Inox - AISI 304 Stainless steel - AISI 304
	2 O-Ring	Elastomero per acqua potabile Elastomer for drinking water
	3 Ghiera Closing ring	Nylon
	4 Corpo Body	Ottone CW617N - UNI EN 12165 Brass CW617N - UNI EN 12165

NORMATIVE

- ISO 21003-3

I raccordi sono conformi alla norma ISO 21003-3: "Sistemi di tubazioni multistrato per le installazioni di acqua calda e fredda all'interno degli edifici."

- NORMA 1254-7-8

I raccordi sono conformi alla norma UNI EN 1254-7-8: "Rame e leghe di rame - Raccorderia idraulica - Parte 8: Raccordi a pressare per utilizzo con tubi di plastica e multistrato".

- UNI EN 10226-1

Tutte le filettature sono conformi alla norma UNI EN 10226-1: "Filettatura di tubazioni per accoppiamento a tenuta sul filetto".

- D.M. 174 (06/04/2004)

Materiali conformi al D.M. n° 174 del 06/04/2004 [Regolamento concernente i materiali e gli oggetti che possono essere utilizzati negli impianti fissi di captazione, trattamento, adduzione e distribuzione delle acque destinate al consumo umano.

- Conforme a 4MS, UBA List (gruppo BC), DIN 50930/6 Dir. 2011/65/UE, 6C allegato III (RhOSII)
- Conforme a DVGW - W534 - ISO21003
- Conforme a KIWA ATA - ISO21003

REGULATIONS

- ISO 21003-3

"Multilayer piping systems for hot and cold water supply installations inside building"

- 1254-7-8 REGULATION

Fittings comply with UNI EN 1254-7-8 law. Part 8: "Fittings with press ends for use with plastics and multilayer pipes".

- UNI EN 10226-1



















Threads comply with UNI EN 10226-1 law: "Piping thread for coupling on the thread".

- D.M. 174 (06/04/2004)

Raw materials used are of high quality and comply with the Ministerial Decree N°174 dated 06/04/2004 concerning the materials and the items used in fixed installations for water collection, treatment and supply.

- Comply with 4MS, UBA List (BC group), DIN 50930/6 Dir. 2011/65/UE, 6C attachment III (RhOSII).
- Comply with DVGW W534 - ISO21003
- Comply with KIWA ATA - ISO21003

CERTIFICAZIONI CERTIFICATIONS

STATO COUNTRY	CERTIFICAZIONE CERTIFICATION	STATO COUNTRY	CERTIFICAZIONE CERTIFICATION
			
			
			
			
			

ISTRUZIONI DI MONTAGGIO ASSEMBLY INSTRUCTIONS

Utilizzando un apposito utensile taglia tubi [codice TT50.00] eseguire un taglio perpendicolare all'asse del tubo.

Cut the pipe perpendicularly to its axis using an appropriate pipe-cutting tool [code TT500.00].



Calibrare e sbavare il tubo con apposito calibro [codice CS50.00; MA00.90], facendo attenzione ad eliminare eventuali trucioli residui.

Lo smusso interno deve essere compiuto su tutta la circonferenza.

Calibrate the pipe using special reamer [code CS50.00, MA00.90], removing possible residual chips. The pipe edge should be trimmed throughout the circumference.



Calzare il tubo sul portatubo del raccordo fino a battuta con l'anello plastico.

Il tubo è inserito correttamente quando è visibile attraverso tutte le finestre di ispezione della ghiera di plastica.

Insert the pipe into the pipe holder until the pipe stops at the plastic ring. Check that the pipe is properly inserted and visible from all inspection windows.



Posizionare la pinza di pressatura e azionare il pulsante elettrico della macchina pressatrice.
Attenzione: il non corretto posizionamento della pinza potrebbe pregiudicare il funzionamento del sistema.

*Place the pressing jaws and operate the electric button of the pressing machine.
An improper placing of the jaws could damage the proper system functioning.*

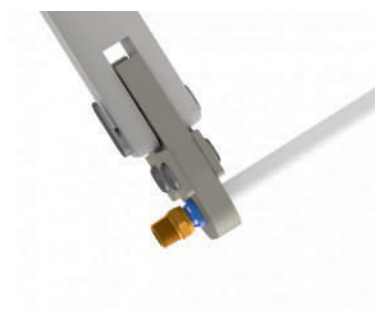

5T00.00

RACCORDO DIRITTO DOPPIO
DOUBLE STRAIGHT FITTING



CODICE	+	Ø	◇	☐
5T0000H162000T	2.0	16x16	10	100
5T0000H202000T	2.0	20x20	10	90
5T0000H252500T	2.5	25x25	5	-
5T0000H263000T	3.0	26x26	5	40
5T0000H323000T	3.0	32x32	5	25
5T0000H403500T	3.5	40x40	-	14
5T0000H504000T	4.0	50x50	-	15
5T0000H634500T	4.5	63x63	-	4

5T00.01

RACCORDO DIRITTO MASCHIO
MALE STRAIGHT FITTING



CODICE	+	Ø	◇	☐
5T0001H031620T	2.0	3/8"x16	10	120
5T0001H041620T	2.0	1/2"x16	10	120
5T0001H042020T	2.0	1/2"x20	10	100
5T0001H042525T	2.5	1/2"x25	5	-
5T0001H042630T	3.0	1/2"x26	5	50
5T0001H051620T	2.0	3/4"x16	10	90
5T0001H052020T	2.0	3/4"x20	10	80
5T0001H052525T	2.5	3/4"x25	5	-
5T0001H052630T	3.0	3/4"x26	5	50
5T0001H102525T	2.5	1/2"x25	5	-
5T0001H102630T	3.0	1"x26	5	40
5T0001H103230T	3.0	1"x32	5	30
5T0001H124035T	3.5	1"1/4x40	-	20
5T0001H145040T	4.0	1"1/2x50	-	20
5T0001H206345T	4.5	2"x63	-	8

5T00.02RACCORDO DIRITTO FEMMINA
FEMALE STRAIGHT FITTING

CODICE	+	Ø	◇	□
5T0002H041620T	2.0	1/2"x16	10	100
5T0002H042020T	2.0	1/2"x20	10	80
5T0002H042525T	2.5	1/2"x25	5	-
5T0002H042630T	3.0	1/2"x26	5	50
5T0002H051620T	2.0	3/4"x16	10	50
5T0002H052020T	2.0	3/4"x20	10	50
5T0002H052525T	2.5	3/4"x25	5	-
5T0002H052630T	3.0	3/4"x26	5	40
5T0002H102525T	2.5	1"x25	5	-
5T0002H102630T	3.0	1"x26	5	40
5T0002H103230T	3.0	1"x32	5	30
5T0002H124035T	3.5	1"1/4x40	-	20
5T0002H145040T	4.0	1"1/2x50	-	10

5T00.03RACCORDO DIRITTO RIDOTTO
REDUCED STRAIGHT FITTING

CODICE	+	Ø	◇	□
5T0003H595600T	2.25/2.0	16x16	-	-
5T0003H665600T	2.0/2.0	20x16	10	100
5T0003H676600T	2.5/2.0	20x20	-	-
5T0003H696600T	2.25/2.0	20x20	-	-
5T0003H745600T	2.5/2.0	25x16	5	-
5T0003H746600T	2.5/2.0	25x20	5	-
5T0003H777400T	3.0x2.5	26x25	-	-
5T0003H775600T	3.0/2.0	26x16	5	40
5T0003H776600T	3.0/2.0	26x20	5	40
5T0003H806600T	3.0/2.0	32x20	5	30
5T0003H807400T	3.0/2.5	32x25	-	-
5T0003H807700T	3.0/3.0	32x26	5	30
5T0003H837700T	3.5/3.0	40x26	-	20
5T0003H838000T	3.5/3.0	40x32	-	20
5T0003H878000T	4.0/3.0	50x32	-	14
5T0003H878300T	4.0/3.5	50x40	-	10
5T0003H918300T	4.5/3.5	63x40	-	7
5T0003H918700T	4.5/4.0	63x50	-	6

5T00.07

RACCORDO DIRITTO ADATTATORE
PER TUBO RAME E ACCIAIO
STRAIGHT FITTING ADAPTER FOR COPPER
AND STEEL PIPE



CODICE	+	Ø	◇	☐
5T0007H162025T	2.0	16x15	10	150
5T0007H202031T	2.0	20x22	10	80
5T0007H252231T	2.5	25x22	5	-
5T0007H262231T	3.0	20x22	5	50
5T0007H322833T	3.0	32x28	-	-

5T00.10

RACCORDO A T
TEE



CODICE	+	Ø	◇	☐
5T0010H162000T	2.0	16x16x16	10	50
5T0010H202000T	2.0	20x20x20	10	40
5T0010H252500T	2.5	25x25x25	5	-
5T0010H263000T	3.0	26x26x26	5	20
5T0010H323000T	3.0	32x32x32	5	10
5T0010H403500T	3.5	40x40x40	-	6
5T0010H504000T	4.0	50x50x50	-	4
5T0010H634500T	4.5	63x63x63	-	-

5T00.11

RACCORDO A T MASCHIO
MALE TEE



CODICE	+	Ø	◇	☐
5T0011H041620T	2.0	16x1/2"x16	10	60
5T0011H042020T	2.0	20x1/2"x20	10	40
5T0011H042525T	2.5	25x1/2"x25	5	-
5T0011H042630T	3.0	26x1/2"x26	5	25
5T0011H052020T	2.0	20x3/4"x20	10	30
5T0011H052525T	2.5	25x3/4"x25	5	-
5T0011H052630T	3.0	26x3/4"x26	5	25
5T0011H102525T	2.5	25x1"x25	5	-
5T0011H102630T	3.0	26x1"x26	5	20
5T0011H103230T	3.0	32x1"x32	5	10

5T00.12RACCORDO A T FEMMINA
FEMALE TEE

CODICE	+	Ø	◇	☐
5T0012H041620T	2.0	16x1/2"x16	10	50
5T0012H042020T	2.0	20x1/2"x20	10	40
5T0012H042525T	2.5	25x1/2"x25	5	-
5T0012H042630T	3.0	26x1/2"x26	5	30
5T0012H052020T	2.0	20x3/4"x20	10	30
5T0012H052525T	2.5	25x3/4"x25	5	20
5T0012H052630T	3.0	26x3/4"x26	5	25
5T0012H102630T	3.0	26x1"x26	5	20
5T0012H103230T	3.0	32x1"x32	5	10
5T0012H124035T	3.5	40x1"1/4x40	-	8
5T0012H145040T	4.0	50x1"1/2x50	-	4
5T0012H106345T	4.5	63x1"x63	-	3
5T0012H206345T	4.5	63x2"x63	-	2

5T00.13RACCORDO A T RIDOTTO
REDUCED TEE

CODICE	+	Ø	◇	☐
5T0013H566656T	2.0/2.0/2.0	16x20x16	10	40
5T0013H567456T	2.0/2.5/2.0	16x25x16	10	-
5T0013H6665656T	2.0/2.0/2.0	20x16x16	10	40
5T0013H6665666T	2.0/2.0/2.0	20x16x20	10	40
5T0013H666656T	2.0/2.0/2.0	20x20x16	10	40
5T0013H667456T	2.0/2.5/2.0	20x25x16	10	-
5T0013H667466T	2.0/2.5/2.0	20x25x20	5	-
5T0013H667766T	2.0/2.0/2.0	20x26x20	5	20
5T0013H745656T	2.5/2.0/2.0	25x16x16	5	-
5T0013H745666T	2.5/2.0/2.0	25x16x20	5	-
5T0013H745674T	2.5/2.0/2.5	25x16x25	5	-
5T0013H746666T	2.5/2.0/2.0	25x20x20	5	-
5T0013H746674T	2.5/2.0/2.5	25x20x25	5	-
5T0013H747456T	2.5/2.5/2.0	25x25x16	5	-
5T0013H747466T	2.5/2.5/2.0	25x25x20	5	-
5T0013H775656T	3.0/2.0/2.0	26x16x16	5	20
5T0013H775666T	3.0/2.0/2.0	26x16x20	5	20
5T0013H775677T	3.0/2.0/3.0	26x16x26	5	20
5T0013H776666T	3.0/2.0/2.0	26x20x20	5	20
5T0013H776677T	3.0/2.0/3.0	26x20x26	5	20
5T0013H777756T	3.0/3.0/2.0	26x26x16	5	20
5T0013H777766T	3.0/3.0/2.0	26x26x20	5	20
5T0013H778077T	3.0/3.0/3.0	26x32x26	5	15
5T0013H805680T	3.0/2.0/3.0	32x16x32	5	10
5T0013H806666T	3.0/2.0/2.0	32x20x20	5	15
5T0013H806677T	3.0/2.0/3.0	32x20x26	5	15
5T0013H806680T	3.0/2.0/3.0	32x20x32	5	10
5T0013H807777T	3.0/3.0/3.0	32x26x26	5	10

5T00.13

RACCORDO A T RIDOTTO
REDUCED TEE



CODICE	+	Ø	◇	☐
5T0013H807780T	3.0/3.0/3.0	32x26x32	5	10
5T0013H808066T	3.0/3.0/2.0	32x32x20	5	10
5T0013H808077T	3.0/3.0/3.0	32x32x26	5	10
5T0013H837780T	3.5/3.0/3.0	40x26x32	-	8
5T0013H837783T	3.5/3.0/3.5	40x26x40	-	6
5T0013H838080T	3.5/3.0/3.0	40x32x32	-	8
5T0013H838083T	3.5/3.0/3.5	40x32x40	-	6
5T0013H877787T	4.0/3.0/4.0	50x26x50	-	4
5T0013H878087T	4.0/3.0/4.0	50x32x50	-	4
5T0013H878387T	4.0/3.5/4.0	50x40x50	-	4
5T0013H918391T	4.5/3.5/4.5	63x40x63	-	2

5T00.20

ANGOLO DOPPIO
DOUBLE ELBOW



CODICE	+	Ø	◇	☐
5T0020H162000T	2.0	16x16	10	100
5T0020H202000T	2.0	20x20	10	60
5T0020H252500T	2.5	25x25	5	-
5T0020H263000T	3.0	26x26	5	30
5T0020H323000T	3.0	32x32	5	20
5T0020H403500T	3.5	40x40	-	10
5T0020H504000T	4.0	50x50	-	6
5T0020H634500T	4.5	63x63	-	3

5T00.96

RACCORDO A T FEMMINA DISASSATO
FEMALE WALL TEE



CODICE	+	Ø
5T0096H041620T	2.0	16x1/2"x16
5T0096H042020T	2.0	20x1/2"x20

5T00.21

ANGOLO MASCHIO
MALE ELBOW



CODICE	+	Ø	◇	☐
5T0021H041620T	2.0	1/2"x16	10	100
5T0021H042020T	2.0	1/2"x20	10	60
5T0021H051620T	2.0	3/4"x16	-	-
5T0021H052020T	2.0	3/4"x20	10	60
5T0021H052525T	2.5	3/4"x25	5	-
5T0021H052630T	3.0	3/4"x26	5	40
5T0021H102525T	2.5	1"x25	5	-
5T0021H102630T	3.0	1"x26	5	25
5T0021H103230T	3.0	1"x32	5	20
5T0021H124035T	3.5	1"1/4x40	-	12
5T0021H145040T	4.0	1"1/2x50	-	8
5T0021H206345T	4.5	2"x63	-	4

5T00.22

ANGOLO FEMMINA
FEMALE ELBOW



CODICE	+	Ø	◇	☐
5T0022H041620T	2.0	1/2"x16	10	80
5T0022H042020T	2.0	1/2"x20	10	60
5T0022H042525T	2.5	1/2"x25	5	-
5T0022H042630T	3.0	1/2"x26	5	30
5T0022H051620T	2.0	3/4"x16	-	-
5T0022H052020T	2.0	3/4"x20	10	50
5T0022H052525T	2.5	3/4"x25	5	-
5T0022H052630T	3.0	3/4"x26	5	30
5T0022H102525T	2.5	1"x25	5	-
5T0022H102630T	3.0	1"x26	5	25
5T0022H103230T	3.0	1"x32	5	25
5T0022H124035T	3.5	1"1/4x40	-	12
5T0022H145040T	4.0	1"1/2x50	-	8
5T0022H206345T	4.5	2"x63	-	4

5T00.23 ATTACCO A MURO 3 FORI
WALLPLATE ELBOW WITH 3 HOLES



CODICE	+	Ø	◇	☐
5T0023H041620T	2.0	1/2"x16 H=47	10	50
5T0023H041635T	2.0	1/2"x16 H=35	10	50
5T0023H042020T	2.0	1/2"x20 H=49	10	40
5T0023H052020T	2.0	3/4"x20 H=52	10	30
5T0023H052525T	2.5	3/4"x25 H=52	5	-
5T0023H052630T	3.0	3/4"x26 H=52	5	25

5T00.29 ANGOLO RIDOTTO
REDUCED ELBOW



CODICE	+	Ø	◇	☐
5T0029H665600T	2.0	20x16	10	60

AC00.80 STAFFA ATTACCO A MURO CON VITI 7.5°/15°
WALL FIXING BRACKET AND SCREWS 7.5°/15°

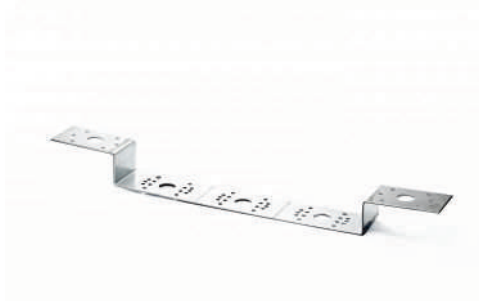

CODICE	+	☐
AC0080H75B506H	1.5 mm	12
AC0080H75B5P6H	2.5 mm	12

Staffa sagomata per fissaggio a muro per raccordo gomito femmina con flangia, in acciaio zincato 1.5 mm/2.5 mm, profondità sagomatura 30 mm, simmetrica, interasse di posa 75 - 150 mm, inclinazioni possibili 0°/7.5°/15°. Applicabile su qualsiasi supporto (cartongesso, legno, muratura). Lunghezza 370 mm. Completa di viti per fissaggio raccordi.

Sectionable bracket with screws. Moulded bracket for female elbow with flange fastening to wall, zinc-plated 1.5/2.5 mm, mould depth 30 mm, symmetrical, laying distance center to center 75 - 150 mm, possible grade 0°/7.5°/15°. It is suitable for any support (plasterboard, wood, masonry). Length 370 mm. Together with screws for fittings fastening.

5T00.34 ATTACCO A MURO DOPPIO CON FLANGIA 3 FORI
DOUBLE WALLPLATE ELBOW WITH 3 HOLES



CODICE	+	i	Ø	◇	☐
5T0034H160416T	2.0	fino ad esaurimento scorte	16x1/2"x16	5	15
5T0034H200420T	2.0	fino ad esaurimento scorte	20x1/2"x20	5	15

5T00.34.D ATTACCO A MURO DOPPIO IN BRONZO CON FLANGIA 3 FORI
 DOUBLE WALLPLATE ELBOW IN BRONZE WITH 3 HOLES



CODICE	+	Ø	◇
5T0034D041620T	2.0	16x1/2"x16	5
5T0034D042020T	2.0	20x1/2"x20	5

5T00.30 CURVA PER RADIATORE PER TUBO RAME Ø 15
 RADIATOR END CONNECTION FOR COPPER PIPE Ø 15

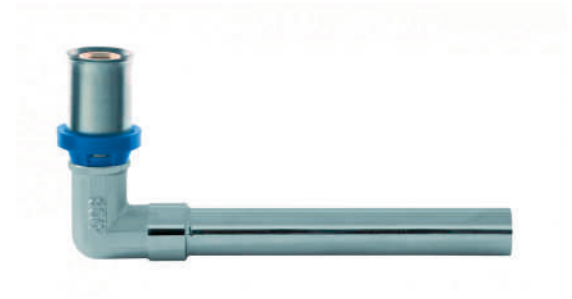

CODICE	+	Ø	◇	▣
5T0030N161500T	2.0	16x15 H 50	10	70
5T0030N161501T	2.0	16x15 H 150	5	40
5T0030N161502T	2.0	16x15 H 300	2	40

5T00.74 RUBINETTO A INCASSO CON VITONE ESTRAIBILE
 IN-WALL SHUT VALVE



CODICE	+	Ø	◇	▣
5T0074H162000T	2.0	16x16	6	12
5T0074H202000T	2.0	20x20	6	12

6R00.76 VITONE COMPLETO PER RUBINETTO INCASSO
 COMPLETE SHUT FOR IN-WALL TAP



CODICE
6R0076H042219H

5S00.43 PROLUNGA PER VALVOLA A SFERA A INCASSO
 EXTENSION FOR IN-WALL BALL-VALVE



CODICE	▣
5S0043H221900H	100

5S00.84 SET LEVA E ROSONE PER VALVOLA A INCASSO
 PLATE AND LEVER FOR BUILT-IN VALVE



CODICE

5S0084C081602H

5S00.84 BLU SET MANOPOLA E ROSONE PER VALVOLA A INCASSO
 PLATE AND RED HANDLE FOR BUILT-IN VALVE



CODICE

5S0084C0816B1H

5S00.84 ROSSO SET MANOPOLA E ROSONE PER VALVOLA A INCASSO
 PLATE AND RED HANDLE FOR BUILT-IN VALVE



CODICE

5S0084C0816R1H

5W00.84 SET CAPPUCCIO/ROSONE
 SET CAP/ROSETTE



CODICE



5W0084C081600H

50

5T00.85 RACCORDO DIRITTO ADATTATORE PER TUBO RAME A COMPRESSIONE
 STRAIGHT FITTING ADAPTER FOR COPPER COMPRESSION PIPE



CODICE



5T0085H161200T 2.0 16x12 10 120

5T0085H161500T 2.0 16x15 10 120

5T0085H162200T 2.0 16x22 - -

5T0085H201500T 2.0 20x15 - -

5T0085H202200T 2.0 20x22 10 50

5T0085H262200T 3.0 26x22 5 40

5T00.C1 TAPPO
CAP



CODICE	+	Ø	◇	☐
5T00C1H162000T	2.0	16	10	100
5T00C1H202000T	2.0	20	10	100
5T00C1H252500T	2.5	25	5	-
5T00C1H263000T	3.0	26	5	70

5T00.C6 STAFFA E RACCORDI TERMINALI
BRACKET AND END FITTINGS



CODICE	+	Ø	☐
5T00C6H045656T	2.0	1/2"x16	12
5T00C6H046666T	2.0	1/2"x20	12

5T00.C7 RACCORDO DIRITTO SEDE PIANA CON GIRELLO
STRAIGHT FITTING WITH LOOSE NUT AND FLAT
WASHER



CODICE	+	Ø	◇	☐
5T00C7H041620T	2.0	1/2"x16	10	100
5T00C7H042020T	2.0	1/2"x20	10	100
5T00C7H051620T*	2.0	3/4"x16	10	100
5T00C7H052020T*	2.0	3/4"x20	10	60
5T00C7H052630T*	3.0	3/4"x26	5	60
5T00C7H102630T	3.0	1"x26	5	60
5T00C7H123230T	3.0	1"1/4x32	5	25

*Utilizzabile con attacchi Eurocono tramite adattatore a sede piana

*It can be used with Euroconus connections via flat seat adapter

5T00.G3 ANGOLO CON DADO GIREVOLE E SEDE PIANA
ELBOW WITH LOOSE NUT



CODICE	+	Ø	◇	☐
5T00G3H041620T	2.0	1/2"x16	10	80
5T00G3H042020T	2.0	1/2"x20	10	60
5T00G3H052020T*	2.0	3/4"x20	10	50
5T00G3H052630T*	3.0	3/4"x26	5	30

*Utilizzabile con attacchi Eurocono tramite adattatore a sede piana

*It can be used with Euroconus connections via flat seat adapter

5T00.I5

RACCORDO DIRITTO SEDE CONICA O-RING CON GIRELLO
 STRAIGHT FITTING WITH LOOSE NUT AND CONICAL CONNECTION



CODICE	+	Ø	◇	☐
5T00I5H041620T	2.0	1/2"x16	10	100
5T00I5H042020T	2.0	1/2"x20	10	100
5T00I5H051620T	2.0	3/4"EK. x16	10	100
5T00I5H052020T	2.0	3/4"EK. x20	10	80

5T00.I5.N

RACCORDO DIRITTO NICHELATO SEDE CONICA O-RING CON GIRELLO
 NICKEL PLATED STRAIGHT FITTING WITH LOOSE NUT AND CONICAL CONNECTION



CODICE	+	Ø	◇	☐
5T00I5N041620T	2.0	1/2"x16	10	100
5T00I5N042020T	2.0	1/2"x20	10	100
5T00I5N051620T	2.0	3/4"EK. x16	10	100
5T00I5N052020T	2.0	3/4"EK. x20	10	80

5T00.K4

ANGOLO 45°
 45° ELBOW



CODICE	+	Ø	◇	☐
5T00K4H263000T	3.0	26x26	5	30
5T00K4H323000T	3.0	32x32	5	15

5T00.K7

STAFFA E RACCORDI TERMINALI
 BRACKET AND END FITTINGS



CODICE	+	Ø	☐
5T00K7H045656T	2.0	1/2"x16	10
5T00K7H046666T	2.0	1/2"x20	8

5T00.N2 RACCORDO DIRITTO ADATTATORE PER TUBO RAME A PRESSARE
STRAIGHT FITTING ADAPTER FOR PRESSING COPPER PIPE



CODICE	+	i	Ø	◇	☐
5T00N2R16120MT	2.0	profilo M	12-16	10	150
5T00N2R16150MT	2.0	profilo M	15-16	10	100
5T00N2R20150MT	2.0	profilo M	15-20	10	100
5T00N2R201500T	2.0	profilo V	15-20	10	100
5T00N2R202200T	2.0	profilo V	22-20	10	60
5T00N2R20220MT	2.0	profilo M	22-20	10	60
5T00N2R26220MT	3.0	profilo M	22-26	5	50

5T00.43 RACCORDO DI RIPARAZIONE
REPAIRING FITTING



CODICE	Ø
5T0043H162000T	16x2.0
5T0043H202000T	20x2.0

5T00.E5 TEE BY-PASS
BY-PASS TEE



CODICE	+	Ø	◇	☐
5T00E5H161616T	2.0	16x16x16	2	12
5T00E5H201620T	2.0	20x16x20	2	10
5T00E5H202020T	2.0	20x20x20	2	10

AC00.70 GUSCIO ISOLANTE PER TEE BY-PASS 5T00.E5
INSULATION BOX FOR 5T00.E5



CODICE	Ø
AC0070H5T00E5H	124x124x55

5T00.A5

ANGOLO ADATTATORE PRESSARE - RAME
PRESS ADAPTER ELBOW - COPPER



CODICE	+	Ø	◇	☐
5T00A5H162012T	2.0	16x12	-	-
5T00A5H162015T	2.0	20X15	10	60
5T00A5H202022T	2.0	20x22	-	-

5T00.27

ANGOLO FEMMINA 96°
FEMALE ELBOW 96°



CODICE	+	Ø
5T0027H041620T	2.0	1/2"x16

**AC00.90
NERA**

SCATOLA PER ANGOLO
BOX FOR ELBOW



CODICE	Ø	☐
AC0090H161001H	unica	250



SISTEMI PER TUBO
MULTISTRATO

SAFE_PRESS

RACCORDI MULTIPROFILO
CON SISTEMA L.B.P.
MULTIJAWS PRESS FITTINGS
WITH L.B.P SYSTEM



URANO

SERIE 5S00

LINE 5S00



Raccordi a pressare multiprofilo

Multijaws press fittings

I raccordi a pressare per tubo multistrato della SERIE 5S00 sono stati studiati e testati per essere utilizzati indifferentemente con 6 profili di pinzatura diversi (TH, H, U, B, F, CH).

I raccordi sono utilizzabili in impianti di adduzione di acqua calda e fredda per usi sanitari o di riscaldamento/raffrescamento, in ogni tipo di installazione idraulica (commerciale, domestica, industriale e agricola), in impianti di aria compressa e in linea di massima con fluidi non aggressivi.

Il corpo del raccordo è in ottone, mentre la bussola è realizzata in acciaio AISI 304.

La geometria del raccordo consente un ottimo accoppiamento tra tubo e raccordo in seguito alla pressatura e le finestre sul portabussola permettono di verificare la corretta inserzione del tubo. Due O-Ring garantiscono la tenuta e l'affidabilità del prodotto nel tempo.

L'anello isolante in plastica previene la corrosione elettrolitica.

Nel caso di installazioni sotto traccia, evitare il contatto tra l'impasto cementizio e le parti metalliche del raccordo.

Essendo la tipologia di raccordo irreversibile (non smontabile) è possibile posizionare il raccordo sottotraccia avendo cura di proteggerlo con materiali idonei.

Press fittings for multilayer pipe of LINE 5S00 have been designed and tested to be used with 6 different crimper profiles: TH, H, U, B, F, CH.

Fittings are suitable for cold or hot water supply for sanitary or heating systems, and for any kind of sanitary installation such as domestic, commercial, industry and farming and with non-aggressive fluids.

Fitting body is made of brass, while the sleeve is made of AISI 304 stainless steel.

The geometry of the fitting allows an excellent coupling between pipe and fitting after pressing and the plastic insulation ring windows allow to check the correct insertion of the pipe. Two O-rings guarantee the seal and reliability over time.

Plastic insulation ring prevents electrolytic corrosion

Since the connecting type is irreversible (it is not possible to disassemble), it is possible to place the fittings concealed, taking care of protecting it from non-suitable materials.









VANTAGGI

- Multiprofilo TH, H, U, B, F, CH
- Ampia gamma
- Anello dielettrico con finestra di controllo della corretta posizione del tubo
- Doppio O-Ring
- Approvato DVGW
- Materie prime impiegate di alta qualità [UBA LIST]
- Filetto conico ISO 7/1
- Rintracciabilità del prodotto garantita dal datario impresso sul corpo del raccordo
- Installazione efficiente: possibilità di realizzare impianti in serie e ad anello con l'attacco a muro doppio per garantire una migliore distribuzione e ricambio dell'acqua

ADVANTAGES





- *Multijaw: TH, H, U, B, F, CH*
- *Wide range*
- *Plastic insulation ring to prevent electrolytic corrosion, and with windows to check the correct insertion of pipe*
- *Double O-Ring*
- *DVGW certified*
- *Raw materials complying with UBA LIST*
- *ISO 7/1 threads*
- *Product traceability guaranteed by the date stamped on the body of the fitting*
- *Efficient installation: double wallplate elbow allows to make installations in series or rings for a better distribution and change of water*

CAMPI DI APPLICAZIONI E PRESTAZIONI FIELDS OF APPLICATION

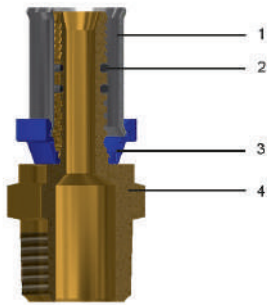
APPLICAZIONI APPLICATIONS		T. min.	T. max	T. di sistema T. of the system	Press.max Max. pressure
	acqua potabile drinking water	-20°C	+120°C	-20°C/+95°C	10 bar (Ø40-50-63 max 6 bar)
	acqua calda sanitaria hot sanitary water	-20°C	+120°C	-20°C/+95°C	10 bar (Ø40-50-63 max 6 bar)
	raffrescamento cooling	-20°C	+120°C	-20°C/+95°C	10 bar (Ø40-50-63 max 6 bar)
	radiatori radiators	-20°C	+120°C	-20°C/+95°C	10 bar (Ø40-50-63 max 6 bar)
	riscaldamento a pavimento floor heating	-20°C	+120°C	-20°C/+95°C	10 bar (Ø40-50-63 max 6 bar)
	irrigazione irrigation	-20°C	+120°C	-20°C/+95°C	10 bar (Ø40-50-63 max 6 bar)
	aria compressa compressed air	-20°C	+120°C	-20°C/+95°C	10 bar (Ø40-50-63 max 6 bar)
	-20°C: solo con liquido antigelo glicole in % max del 30% -20°C: with the use of glycol in a maximum percentage of 30%				

COMPONENTI E MATERIALI COMPONENTS AND MATERIALS



LEGENDA LEGEND	COMPONENTI COMPONENTS	MATERIALI MATERIALS
	1 Bussola Sleeve	Acciaio Inox - AISI 304 Stainless steel - AISI 304
	2 O-Ring	Elastomero per acqua potabile Elastomer for drinking water
	3 Ghiera Closing ring	Nylon
	4 Corpo Body	Ottone CW617N/CW612N - UNI EN 12165 Brass CW617N/CW612N - UNI EN 12165

PROFILI DI PINZATURA PRESSING PROFILES

Ø	TH	H	U	B	F	CH
14x2.0	TH	H	U	-	-	-
16x2.0	TH	H	U	B	F	CH
18x2.0	TH	H	U	-	-	-
20x2.0	TH	H	U	B	F	CH
20x2.25	TH	H	U	-	-	-
25x2.5	TH	H	U	-	-	-
26x3.0	TH	H	-	B	F	CH
32x3.0	TH	H	U	B	F	-
40x3.5	TH	H	U	-	-	-
50x4.0	TH	H	U	-	-	-
63x4.5	TH	-	U	-	-	-

NORMATIVE

- ISO 21003-3
I raccordi sono conformi alla norma ISO 21003-3: "Sistemi di tubazioni multistrato per le installazioni di acqua calda e fredda all'interno degli edifici."
- NORMA 1254-7-8
I raccordi sono conformi alla norma UNI EN 1254-7-8: "Rame e leghe di rame - Raccorderia idraulica - Parte 8: Raccordi a pressare per utilizzo con tubi di plastica e multistrato"
- UNI EN 10226-1
Tutte le filettature sono conformi alla norma UNI EN 10226-1: "Filettatura di tubazioni per accoppiamento a tenuta sul filetto"
- D.M. 174 (06/04/2004)
Materiali conformi al D.M. n° 174 del 06/04/2004

REGULATIONS

- ISO 21003-3
"Multilayer piping systems for hot and cold water supply installations inside building"
- 1254-7-8 REGULATION
Fittings comply with UNI EN 1254-7-8 law. Part 8: "Fittings with press ends for use with plastics and multilayer pipes".
- UNI EN 10226-1
Threads comply with UNI EN 10226-1 law: "Piping thread for coupling on the thread".
- D.M. 174 (06/04/2004)
Raw materials used are of high quality and comply with the Ministerial Decree N°174 dated 06/04/2004 concerning the materials and the items used in fixed installations for water collection, treatment and supply.
- Comply with 4MS, UBA List (BC group), DIN 50930/6 Dir.

[Regolamento concernente i materiali e gli oggetti che possono essere utilizzati negli impianti fissi di captazione, trattamento, adduzione e distribuzione delle acque destinate al consumo umano]

- Conforme a 4MS, UBA List (gruppo BC), DIN 50930/6 Dir. 2011/65/UE, 6C allegato III (RhOSII)
- Conforme a DVGW W534

2011/65/UE, 6C attachment III (RhOSII).

- Comply with DVGW W534

CERTIFICAZIONI CERTIFICATIONS

STATO COUNTRY	CERTIFICAZIONE CERTIFICATION	STATO COUNTRY	CERTIFICAZIONE CERTIFICATION	STATO COUNTRY	CERTIFICAZIONE CERTIFICATION
					
					
					
					

ISTRUZIONI DI MONTAGGIO ASSEMBLY INSTRUCTIONS

Utilizzando un apposito utensile taglia tubi [codice TT50.00] eseguire un taglio perpendicolare all'asse del tubo.

Cut the pipe perpendicularly to its axis using an appropriate pipe-cutting tool [code TT50.00].



Calibrare e sbavare il tubo con apposito calibro [codice CS50.00; MA00.90], facendo attenzione ad eliminare eventuali trucioli residui.

Lo smusso interno deve essere compiuto su tutta la circonferenza.

Calibrate the pipe using special reamer [code CS50.00, MA00.90], removing possible residual chips.

The pipe edge should be trimmed throughout the circumference.



Calzare il tubo sul portatubo del raccordo fino a battuta con l'anello plastico.

Il tubo è inserito correttamente quando è visibile attraverso tutte le finestre di ispezione della ghiera di plastica.

Insert the pipe into the pipe holder until the pipe stops at the plastic ring.

Check that the pipe is properly inserted and visible from all inspection windows.



Posizionare la pinza di pressatura e azionare il pulsante elettrico della macchina pressatrice.

Attenzione: il non corretto posizionamento della pinza potrebbe pregiudicare il funzionamento del sistema.

Place the pressing jaws and operate the electric button of the pressing machine.

An improper placing of the jaws could damage the proper system functioning.

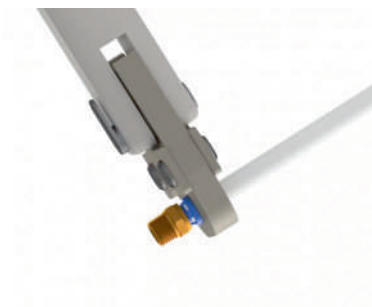

5S00.00RACCORDO DIRITTO DOPPIO
DOUBLE STRAIGHT FITTING

CODICE	+	Ø	◇	☐
5S0000H142000T	2.0	14x14	10	100
5S0000H162000T	2.0	16x16	10	100
5S0000H182000T	2.0	18x18	10	100
5S0000H202000T	2.0	20x20	10	90
5S0000H202200T	2.25	20x20	10	90
5S0000H252500T	2.5	25x25	5	40
5S0000H263000T	3.0	26x26	5	40
5S0000H323000T	3.0	32x32	5	25
5S0000H403500T	3.5	40x40	-	14
5S0000H504000T	4.0	50x50	-	15
5S0000H634500T	4.5	63x63	-	4

5S00.01RACCORDO DIRITTO MASCHIO
MALE STRAIGHT FITTING

CODICE	+	Ø	◇	☐
5S0001H031620T	2.0	3/8"x16	10	120
5S0001H041620T	2.0	1/2"x16	10	120
5S0001H041820T	2.0	1/2"x18	10	100
5S0001H042020T	2.0	1/2"x20	10	100
5S0001H042022T	2.25	1/2"x20	10	100
5S0001H042525T	2.5	1/2"x25	5	50
5S0001H042630T	3.0	1/2"x26	5	50
5S0001H051620T	2.0	3/4"x16	10	90
5S0001H051820T	2.0	3/4"x18	10	80
5S0001H052020T	2.0	3/4"x20	10	80
5S0001H052022T	2.25	3/4"x20	10	80
5S0001H052525T	2.5	3/4"x25	5	50
5S0001H052630T	3.0	3/4"x26	5	50
5S0001H102525T	2.5	1"x25	5	40
5S0001H102630T	3.0	1"x26	5	40
5S0001H103230T	3.0	1"x32	5	40
5S0001H124035T	3.5	1"1/4x40	-	20
5S0001H145040T	4.0	1"1/2x50	-	20
5S0001H206345T	4.5	2"x63	-	8

Tutti i codici ø40-50-63 saranno sostituiti dai codici similari della linea Safe_Press ad esaurimento scorte.
All ø40-50-63 codes will be replaced by similar codes from the Safe_Press line one stocks are exhausted.

5S00.02

RACCORDO DIRITTO FEMMINA
FEMALE STRAIGHT FITTING



CODICE	+	Ø	◇	▢
5S0002H041620T	2.0	1/2"x16	10	100
5S0002H041820T	2.0	1/2"x18	10	80
5S0002H042020T	2.0	1/2"x20	10	80
5S0002H042022T	2.25	1/2"x20	10	80
5S0002H042525T	2.5	1/2"x25	5	50
5S0002H042630T	3.0	1/2"x26	5	50
5S0002H051620T	2.0	3/4"x16	10	50
5S0002H051820T	2.0	3/4"x18	10	50
5S0002H052020T	2.0	3/4"x20	10	50
5S0002H052022T	2.25	3/4"x20	10	50
5S0002H052525T	2.5	3/4"x25	5	40
5S0002H052630T	3.0	3/4"x26	5	40
5S0002H102525T	2.5	1"x25	5	40
5S0002H102630T	3.0	1"x26	5	40
5S0002H103230T	3.0	1"x32	5	30
5S0002H124035T	3.5	1"1/4x40	-	14
5S0002H145040T	4.0	1"1/2x50	-	10

5S00.03

RACCORDO DIRITTO RIDOTTO
REDUCED STRAIGHT FITTING



CODICE	+	Ø	◇	▢
5S0003H625600T	2.0/2.0	18x16	10	100
5S0003H665100T	2.0/2.0	20x14	10	100
5S0003H665600T	2.0/2.0	20x16	10	100
5S0003H666200T	2.0/2.0	20x18	10	100
5S0003H695100T	2.25/2.0	20x14	-	100
5S0003H695600T	2.25/2.0	20x16	10	80
5S0003H696200T	2.25/2.0	20x18	10	80
5S0003H745600T	2.5/2.0	25x16	5	40
5S0003H746600T	2.5/2.0	25x20	5	40
5S0003H746900T	2.5/2.25	25x20	5	40
5S0003H775600T	3.0/2.0	26x16	5	40
5S0003H776600T	3.0/2.0	26x20	5	40
5S0003H776900T	3.0/2.25	26x20	5	40
5S0003H806600T	3.0/2.0	32x20	5	30
5S0003H806900T	3.0/2.25	32x20	5	30
5S0003H807400T	3.0/2.5	32x25	5	30
5S0003H807700T	3.0/3.0	32x26	5	30
5S0003H837400T	3.5/2.5	40x25	-	20
5S0003H837700T	3.5/3.0	40x26	-	20
5S0003H838000T	3.5/3.0	40x32	-	20
5S0003H878000T	4.0/3.0	50x32	-	14
5S0003H878300T	4.0/3.5	50x40	-	10
5S0003H918300T	4.5/3.5	63x40	-	7
5S0003H918700T	4.5/4.0	63x50	-	6

Tutti i codici ø40-50-63 saranno sostituiti dai codici similari della linea Safe_Press ad esaurimento scorte.
All ø40-50-63 codes will be replaced by similar codes from the Safe_Press line one stocks are exhausted.

5S00.07

RACCORDO DIRITTO ADATTATORE PER TUBO RAME
STRAIGHT FITTING ADAPTER FOR COPPER PIPE



CODICE	+	Ø	◇	☐
5S0007H162025T	2.0	15-16	10	150
5S0007H202031T	2.0	22-20	10	80
5S0007H202231T	2.25	22-20	10	80
5S0007H262231T	3.0	22-26	5	50

5S00.N2

RACCORDO DIRITTO ADATTATORE PER TUBO RAME
A PRESSARE
STRAIGHT FITTING ADAPTER FOR PRESSING COPPER
PIPE



CODICE	+	i	Ø	◇	☐
5S00N2R161500T	2.0	profilo V	16-15	10	120
5S00N2R16150MT	2.0	profilo M	15-16	10	120
5S00N2R201500T	2.0	profilo V	15-20	10	-
5S00N2R20150MT	2.0	profilo M	15-20	10	100
5S00N2R20151MT	2.0	profilo M	20	10	100
5S00N2R202200T	2.0	profilo V	22-20	10	60
5S00N2R20221MT	2.25	profilo M	20	10	60
5S00N2R20220MT	2.0	profilo M	22-20	10	60
5S00N2R26220MT	3.0	profilo M	22-26	5	50
5S00N2R25220MT	2.25	profilo M	25	5	50

Tutti i codici ø40-50-63 saranno sostituiti dai codici simili della linea Safe_Press ad esaurimento scorte.
All ø40-50-63 codes will be replaced by similar codes from the Safe_Press line one stocks are exhausted.

5S00.85

RACCORDO DIRITTO ADATTATORE PER TUBO RAME
A COMPRESIONE
STRAIGHT FITTING ADAPTER FOR COPPER
COMPRESSION PIPE



CODICE	+	Ø	◇	☐
5S0085H161200T	2.0	12-16	10	120
5S0085H161500T	2.0	15-16	10	100
5S0085H202200T	2.0	22-20	10	50
5S0085H202201T	2.25	22-20	10	50
5S0085H252200T	2.5	22-25	5	50
5S0085H262200T	3.0	22-26	5	50

Fino ad esaurimento scorte, verrà poi sostituito dal Safe_Press 5T00.85

While stocks last, it will then be replaced by Safe_Press 5T00.85

5S00.10 RACCORDO A T
TEE



CODICE	+	Ø	◇	☐
5S0010H162000T	2.0	16x16x16	10	50
5S0010H182000T	2.0	18x18x18	10	40
5S0010H202000T	2.0	20x20x20	10	40
5S0010H202200T	2.25	20x20x20	10	40
5S0010H252500T	2.5	25x25x25	5	20
5S0010H263000T	3.0	26x26x26	5	20
5S0010H323000T	3.0	32x32x32	5	10
5S0010H403500T	3.5	40x40x40	-	6
5S0010H504000T	4.0	50x50x50	-	4
5S0010H634500T	4.5	63x63x63	-	-

5S00.11 RACCORDO A T MASCHIO
MALE TEE



CODICE	+	Ø	◇	☐
5S0011H041620T	2.0	16x1/2"x16	10	60
5S0011H041820T	2.0	18x1/2"x18	10	40
5S0011H042020T	2.0	20x1/2"x20	10	40
5S0011H042022T	2.25	20x1/2"x20	10	40
5S0011H051820T	2.0	18x3/4"x18	10	30
5S0011H052020T	2.0	20x3/4"x20	10	30
5S0011H052022T	2.25	20x3/4"x20	10	30
5S0011H052525T	2.5	25x3/4"x25	5	25
5S0011H052630T	3.0	26x3/4"x26	5	25
5S0011H102630T	3.0	26x1"x26	5	20
5S0011H103230T	3.0	32x1"x32	5	10

Tutti i codici ø40-50-63 saranno sostituiti dai codici similari della linea Safe_Press ad esaurimento scorte.
All ø40-50-63 codes will be replaced by similar codes from the Safe_Press line one stocks are exhausted.

5S00.12**RACCORDO A T FEMMINA
FEMALE TEE**

CODICE	+	Ø	◇	□
5S0012H041620T	2.0	16x1/2"x16	10	50
5S0012H041820T	2.0	18x1/2"x18	10	40
5S0012H042020T	2.0.	20x1/2"x20	10	40
5S0012H042022T	2.25	20x1/2"x20	10	40
5S0012H042525T	2.5	25x1/2"x25	5	30
5S0012H042630T	3.0	26x1/2"x26	5	30
5S0012H051820T	2.0	18x3/4"x18	10	30
5S0012H052020T	2.0	20x3/4"x20	10	30
5S0012H052022T	2.25	20x3/4"x20	10	30
5S0012H052525T	2.5	25x3/4"x25	5	25
5S0012H052630T	3.0	26x3/4"x26	5	25
5S0012H102525T	2.5	25x1"x25	5	20
5S0012H102630T	3.0	26x1"x26	5	20
5S0012H103230T	3.0	32x1"x32	5	10
5S0012H124035T	3.5	40x1"1/4x40	-	8
5S0012H145040T	4.0	50x1"1/2x50	-	4
5S0012H106345T	4.5	63x1"x63	-	3
5S0012H206345T	4.5	63x2"x63	-	2

Tutti i codici ø40-50-63 saranno sostituiti dai codici similari della linea Safe_Press ad esaurimento scorte. All ø40-50-63 codes will be replaced by similar codes from the Safe_Press line one stocks are exhausted.

5S00.13**RACCORDO A T RIDOTTO
REDUCED TEE**

CODICE	+	Ø	◇	□
5S0013H566656T	2.0/2.0/2.0	16x20x16	10	40
5S0013H566956T	2.0/2.25/2.0	16x20x16	10	40
5S0013H625656T	2.0/2.0/2.0	18x16x16	10	40
5S0013H625662T	2.0/2.0/2.0	18x16x18	10	40
5S0013H665166T	2.0/2.0/2.0	20x14x20	10	40
5S0013H665656T	2.0/2.0/2.0	20x16x16	10	40
5S0013H665666T	2.0/2.0/2.0	20x16x20	10	40
5S0013H666262T	2.0/2.0/2.0	20x18x18	10	40
5S0013H666266T	2.0/2.0/2.0	20x18x20	10	40
5S0013H666656T	2.0/2.0/2.0	20x20x16	10	40
5S0013H667466T	2.0/2.0/2.0	20x25x20	5	20
5S0013H667766T	2.0/2.0/2.0	20x26x20	5	20
5S0013H695169T	2.25/2.0/2.25	20x14x20	10	40
5S0013H695656T	2.25/2.0/2.0	20x16x16	10	40
5S0013H695669T	2.25/2.0/2.25	20x16x20	10	40
5S0013H696262T	2.25/2.0/2.0	20x18x18	10	40
5S0013H696269T	2.25/2.0/2.25	20x18x20	10	40
5S0013H696956T	2.25/2.25/2.0	20x20x16	10	40
5S0013H697469T	2.25/2.5/2.25	20x25x20	5	20
5S0013H697769T	2.25/3.0/2.25	20x26x20	5	20
5S0013H745656T	2.5/2.0/2.0	25x16x16	5	20
5S0013H745666T	2.5/2.0/2.0	25x16x20	5	20
5S0013H745669T	2.5/2.0/2.25	25x16x20	5	20
5S0013H745674T	2.5/2.0/2.5	25x16x25	5	20
5S0013H746274T	2.5/2.0/2.5	25x18x25	5	20
5S0013H746666T	2.5/2.0/2.0	25x20x20	5	20
5S0013H746674T	2.5/2.0/2.5	25x20x25	5	20
5S0013H746969T	2.5/2.25/2.25	25x20x20	5	20

5S00.13

RACCORDO A T RIDOTTO
REDUCED TEE



CODICE	+	Ø	◇	□
5S0013H746974T	2.5/2.25/2.5	25x20x25	5	20
5S0013H747456T	2.5/2.5/2.0	25x25x16	5	20
5S0013H747466T	2.5/2.5/2.0	25x25x20	5	20
5S0013H747469T	2.5/2.5/2.25	25x25x20	5	20
5S0013H748074T	2.5/3.0/2.5	25x32x25	5	15
5S0013H775656T	3.0/2.0/2.0	26x16x16	5	20
5S0013H775666T	3.0/2.0/2.0	26x16x20	5	20
5S0013H775669T	3.0/2.0/2.25	26x16x20	5	20
5S0013H775677T	3.0/2.0/3.0	26x16x26	5	20
5S0013H776277T	3.0/2.0/3.0	26x18x26	5	20
5S0013H776666T	3.0/2.0/2.0	26x20x20	5	20
5S0013H776677T	3.0/2.0/3.0	26x20x26	5	20
5S0013H776969T	3.0/2.25/2.25	26x20x20	5	20
5S0013H776977T	3.0/2.25/3.0	26x20x26	5	20
5S0013H777756T	3.0/3.0/2.0	26x26x16	5	20
5S0013H777766T	3.0/3.0/2.0	26x26x20	5	20
5S0013H777769T	3.0/3.0/2.25	26x26x20	5	20
5S0013H778077T	3.0/3.0/3.0	26x32x26	5	15
5S0013H805680T	3.0/2.0/3.0	32x16x32	5	10
5S0013H806280T	3.0/2.0/3.0	32x18x32	5	10
5S0013H806666T	3.0/2.0/2.0	32x20x20	5	15
5S0013H806674T	3.0/2.0/2.5	32x20x25	5	15
5S0013H806677T	3.0/2.0/3.0	32x20x26	5	15
5S0013H806680T	3.0/2.0/3.0	32x20x32	5	10
5S0013H806969T	3.0/2.25/2.25	32x20x20	5	15
5S0013H806974T	3.0/2.25/2.5	32x20x25	5	15
5S0013H806977T	3.0/2.25/3.0	32x20x26	5	15
5S0013H806980T	3.0/2.25/3.0	32x20x32	5	10

5S00.13

RACCORDO A T RIDOTTO
REDUCED TEE



CODICE	+	Ø	◇	□
5S0013H807474T	3.0/2.5/2.5	32x25x25	5	10
5S0013H807480T	3.0/2.5/3.0	32x25x32	5	10
5S0013H807777T	3.0/3.0/3.0	32x26x26	5	10
5S0013H807780T	3.0/3.0/3.0	32x26x32	5	10
5S0013H808066T	3.0/3.0/2.0	32x32x20	5	10
5S0013H808077T	3.0/3.0/3.0	32x32x26	5	10
5S0013H837480T	3.5/2.5/3.0	40x25x32	-	8
5S0013H837483T	3.5/2.5/3.5	40x25x40	-	8
5S0013H877487T	4.0/2.5/4.0	50x25x50	-	4
5S0013H837780T	3.5/3.0/3.0	40x26x32	-	8
5S0013H837783T	3.5/3.0/3.5	40x26x40	-	6
5S0013H838080T	3.5/3.0/3.0	40x32x32	-	8
5S0013H838083T	3.5/3.0/3.5	40x32x40	-	6
5S0013H877787T	4.0/3.0/4.0	50x26x50	-	4
5S0013H878087T	4.0/3.0/4.0	50x32x50	-	4
5S0013H878387T	4.0/3.5/4.0	50x40x50	-	4
5S0013H918391T	4.5/3.5/4.5	63x40x63	-	2
5S0013H918791T	4.5/4.0/4.5	63x50x63	-	2

Tutti i codici ø40-50-63 saranno sostituiti dai codici simili della linea Safe_Press ad esaurimento scorte.
All ø40-50-63 codes will be replaced by similar codes from the Safe_Press line one stocks are exhausted.

5S00.20

ANGOLO DOPPIO
DOUBLE ELBOW



CODICE	+	Ø	◇	☐
5S0020H162000T	2.0	16x16	10	100
5S0020H182000T	2.0	18x18	10	60
5S0020H202000T	2.0	20x20	10	60
5S0020H202200T	2.25	20x20	10	60
5S0020H252500T	2.5	25x25	5	40
5S0020H263000T	3.0	26x26	5	40
5S0020H323000T	3.0	32x32	5	20
5S0020H403500T	3.5	40x40	-	10
5S0020H504000T	4.0	50x50	-	6
5S0020H634500T	4.5	63x63	-	3

5S00.21

ANGOLO MASCHIO
MALE ELBOW



CODICE	+	Ø	◇	☐
5S0021H041620T	2.0	1/2"x16	10	100
5S0021H041820T	2.0	1/2"x18	10	60
5S0021H042020T	2.0	1/2"x20	10	60
5S0021H042022T	2.25	1/2"x20	10	60
5S0021H051820T	2.0	3/4"x18	10	60
5S0021H052020T	2.0	3/4"x20	10	60
5S0021H052022T	2.25	3/4"x20	10	60
5S0021H052525T	2.5	3/4"x25	5	40
5S0021H052630T	3.0	3/4"x26	5	40
5S0021H102630T	3.0	1"x26	5	25
5S0021H103230T	3.0	1"x32	5	20
5S0021H124035T	3.5	1"1/4x40	-	12
5S0021H145040T	4.0	1"1/2x50	-	8
5S0021H206345T	4.5	2"x63	-	4

Tutti i codici ø40-50-63 saranno sostituiti dai codici similari della linea Safe_Press ad esaurimento scorte.
All ø40-50-63 codes will be replaced by similar codes from the Safe_Press line one stocks are exhausted.

5S00.22

ANGOLO FEMMINA
FEMALE ELBOW



CODICE	+	Ø	◇	▢
5S0022H041620T	2.0	1/2"x16	10	80
5S0022H041820T	2.0	1/2"x18	10	60
5S0022H042020T	2.0	1/2"x20	10	60
5S0022H042022T	2.25	1/2"x20	10	60
5S0022H042525T	2.5	1/2"x25	5	30
5S0022H042630T	3.0	1/2"x26	5	30
5S0022H051820T	2.0	3/4"x18	10	50
5S0022H052020T	2.0	3/4"x20	10	50
5S0022H052022T	2.25	3/4"x20	10	50
5S0022H052525T	2.5	3/4"x25	5	30
5S0022H052630T	3.0	3/4"x26	5	30
5S0022H102525T	2.5	1"x25	5	25
5S0022H102630T	3.0	1"x26	5	25
5S0022H103230T	3.0	1"x32	5	25
5S0022H124035T	3.5	1"1/4x40	-	12
5S0022H145040T	4.0	1"1/2x50	-	8
5S0022H206345T	4.5	2"x63	-	4

5S00.23

ATTACCO A MURO CON FLANGIA 3 FORI
WALLPLATE ELBOW WITH 3 HOLES



CODICE	+	i	Ø	◇	▢
5S0023H041635T	2.0	Compact	1/2"x16 H=35	10	50
5S0023H041620T	2.0	-	1/2"x16 H=47	10	50
5S0023H041820T	2.0	-	1/2"x18 H=49	10	50
5S0023H042020T	2.0	-	1/2"x20 H=49	10	40
5S0023H042022T	2.25	-	1/2"x20 H=49	10	40
5S0023H052020T	2.0	-	3/4"x20 H=52	10	30
5S0023H052022T	2.25	-	3/4"x20 H=52	10	30
5S0023H052525T	2.5	-	3/4"x25 H=52	5	25
5S0023H052630T	3.0	-	3/4"x26 H=52	5	25

5S00.K4

ANGOLO 45°
45° ELBOW



CODICE	+	Ø	◇	▢
5S00K4H263000T	3.0	26 x 26	5	30
5S00K4H323000T	3.0	32 x 32	5	15

Tutti i codici ø40-50-63 saranno sostituiti dai codici similari della linea Safe_Press ad esaurimento scorte.
All ø40-50-63 codes will be replaced by similar codes from the Safe_Press line one stocks are exhausted.

AC00.80 STAFFA ATTACCO A MURO CON VITI 7.5°/15°
WALL FIXING BRACKET AND SCREWS 7.5°/15°

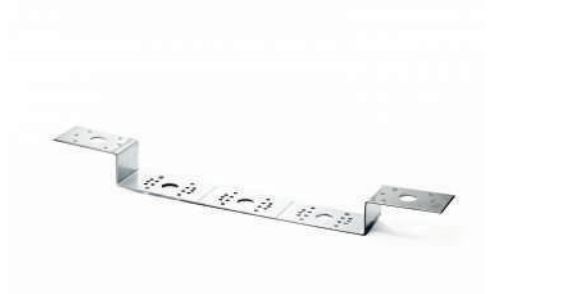

CODICE	+	☐
AC0080H75B506H	1.5 mm	12
AC0080H75B5P6H	2.5 mm	12

Staffa sagomata per fissaggio a muro per raccordo gomito femmina con flangia, in acciaio zincato 1.5 mm/2.5 mm, profondità sagomatura 30 mm, simmetrica, interasse di posa 75 - 150 mm, inclinazioni possibili 0°/7.5°/15°. Applicabile su qualsiasi supporto (cartongesso, legno, muratura). Lunghezza 370 mm. Completa di viti per fissaggio raccordi.

Sectionable bracket with screws. Moulded bracket for female elbow with flange fastening to wall, zinc-plated 1.5/2.5 mm, mould depth 30 mm, symmetrical, laying distance center to center 75 - 150 mm, possible grade 0°/7.5°/15°. It is suitable for any support (plasterboard, wood, masonry). Length 370 mm. Together with screws for fittings fastening.

5S00.30 CURVA TERMOSTATICA PER RADIATORE PER TUBO
RAME Ø 15
RADIATOR END CONNECTION FOR COPPER PIPE Ø 15

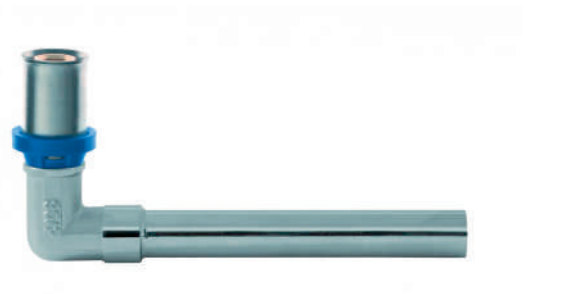

CODICE	+	∅	◇	☐
5S0030N161500T	2.0	16x15 H 50	-	60
5S0030N161501T	2.0	16x15 H 150	5	40
5S0030N161502T	2.0	16x15 H 300	2	40

5S00.34 ATTACCO A MURO DOPPIO CON FLANGIA 3 FORI
DOUBLE WALLPLATE ELBOW WITH 3 HOLES



CODICE	+	∅	◇	☐
5S0034H160416T	2.0	16x1/2"x16	5	15
5S0034H200420T	2.0	20x1/2"x20	5	15
5S0034H200422T	2.25	20x1/2"x20	5	15

Fino ad esaurimento scorte, poi sostituito dal Safe_Press 5T00.34

While stocks last, then replaced by Safe_Press 5T00.34.

5S00.C6 STAFFA E RACCORDI TERMINALI
BRACKET AND END FITTINGS



CODICE	+	H	∅	☐
5S00C6H045656T	2.0	153 mm	1/2"x16	12
5S00C6H046666T	2.0	153 mm	1/2"x20	12

Tutti i codici ø40-50-63 saranno sostituiti dai codici similari della linea Safe_Press ad esaurimento scorte.
All ø40-50-63 codes will be replaced by similar codes from the Safe_Press line one stocks are exhausted.

5S00.K7 STAFFA E RACCORDI TERMINALI
BRACKET AND END FITTINGS



CODICE	+	H	Ø	📦
5S00K7H045656T	2.0	153 mm	1/2"x16	10
5S00K7H046666T	2.0	153 mm	1/2"x20	8

5S00.C1 TAPPO
CAP



CODICE	+	Ø	◇	📦
5S00C1H162000T	2.0	16	10	100
5S00C1H202000T	2.0	20	10	100
5S00C1H252500T	2.5	25	5	70
5S00C1H263000T	2.0	26	5	70

PR5S.75 VALVOLA A SFERA A INCASSO
IN-WALL BALL VALVE



CODICE	+	Ø	◇	📦
PR5S75N162000T	2.0	16x2.0	6	12
PR5S75N202000T	2.0	20x2.0	6	12
PR5S75N202200T	2.25	20x20	6	12

5S00.74 RUBINETTO A INCASSO CON VITONE ESTRAIBILE
IN-WALL SHUT VALVE



CODICE	+	Ø	◇	📦
5S0074H162000T	2.0	16x16	6	12
5S0074H202000T	2.0	20x20	6	12

Tutti i codici ø40-50-63 saranno sostituiti dai codici similari della linea Safe_Press ad esaurimento scorte.
All ø40-50-63 codes will be replaced by similar codes from the Safe_Press line one stocks are exhausted.

6R00.76 VITONE COMPLETO PER RUBINETTO INCASSO
COMPLETE SHUT FOR IN-WALL TAP



CODICE

6R0076H042219H

5S00.84 BLU SET MANOPOLA E ROSONE PER VALVOLA A
INCASSO
PLATE AND RED HANDLE FOR BUILT-IN VALVE



CODICE

5S0084C0816B1H

5S00.43 PROLUNGA PER VALVOLA A SFERA A INCASSO
EXTENSION FOR IN-WALL BALL-VALVE



CODICE

5S0043H221900H



100

5S00.84 ROSSO SET MANOPOLA E ROSONE PER VALVOLA A
INCASSO
PLATE AND RED HANDLE FOR BUILT-IN VALVE



CODICE

5S0084C0816R1H

5S00.84 SET LEVA E ROSONE PER VALVOLA A INCASSO
PLATE AND LEVER FOR BUILT-IN VALVE



CODICE

5S0084C081602H

5W00.84 SET CAPPUCCIO/ROSONE
SET CAP/ROSETTE



CODICE

5W0084C081600H



50

Tutti i codici ø40-50-63 saranno sostituiti dai codici similari della linea Safe_Press ad esaurimento scorte.
All ø40-50-63 codes will be replaced by similar codes from the Safe_Press line one stocks are exhausted.

5S00.C7

RACCORDO DIRITTO SEDE PIANA CON GIRELLO CON
GUARNIZIONE
STRAIGHT FITTING WITH LOOSE NUT AND FLAT
WASHER



CODICE	+	Ø	◇	☐
5S00C7H041620T	2.0	1/2"x16	10	100
5S00C7H042020T	2.0	1/2"x20	10	100
5S00C7H051620T*	2.0	3/4"x16	10	100
5S00C7H051820T*	2.0	3/4"x18	10	60
5S00C7H052020T*	2.0	3/4"x20	10	60
5S00C7H052022T*	2.25	3/4"x20	10	60
5S00C7H052525T*	2.5	3/4"x25	5	60
5S00C7H052630T*	3.0	3/4"x26	5	60
5S00C7H102525T	2.5	1"x25	5	60
5S00C7H102630T	3.0	1"x26	5	60
5S00C7H123230T	3.0	1"1/4x32	5	25

*Utilizzabile con attacchi Eurocono tramite adattatore a sede piana

*It can be used with Euroconus connections via flat seat adapter

5S00.G3

ANGOLO CON DADO GIREVOLE E SEDE PIANA CON
GUARNIZIONE
ELBOW WITH LOOSE NUT

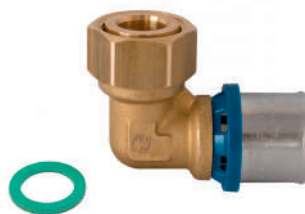

CODICE	+	Ø	◇	☐
5S00G3H041620T	2.0	1/2"x16	10	80
5S00G3H042020T	2.0	1/2"x20	10	60
5S00G3H052020T*	2.0	3/4"x20	10	50
5S00G3H052022T*	2.25	3/4"x20	10	50
5S00G3H052525T*	2.5	3/4"x25	5	30
5S00G3H052630T*	3.0	3/4"x26	5	30

*Utilizzabile con attacchi Eurocono tramite adattatore a sede piana

*It can be used with Euroconus connections via flat seat adapter

5S00.I5

RACCORDO DIRITTO SEDE CONICA O-RING
CON GIRELLO
STRAIGHT FITTING WITH LOOSE NUT
AND CONICAL CONNECTION



CODICE	+	Ø	◇	☐
5S00I5H041620T	2.0	1/2"x16	10	100
5S00I5H042020T	2.0	1/2"x20	10	100
5S00I5H042022T	2.25	1/2"x20	-	100
5S00I5H051620T	2.0	3/4" EK x 16	10	100
5S00I5H051820T	2.0	3/4" EK x 18	10	100
5S00I5H052020T	2.0	3/4" EK x 20	10	80
5S00I5H052022T	2.25	3/4" EK x 20	-	80

Tutti i codici ø40-50-63 saranno sostituiti dai codici similari della linea Safe_Press ad esaurimento scorte.
All ø40-50-63 codes will be replaced by similar codes from the Safe_Press line one stocks are exhausted.

5S00.I5.N

RACCORDO DIRITTO NICHELATO SEDE CONICA O-RING
CON GIRELLO
NICKEL-PLATED STRAIGHT FITTING WITH LOOSE
NUT AND CONICAL CONNECTION



CODICE	+	Ø	◇	☐
5S00I5N041620T	2.0	1/2"x16	10	100
5S00I5N042020T	2.0	1/2"x20	10	100
5S00I5N042022T	2.25	1/2"x20	10	100
5S00I5N051620T	2.0	3/4" EK x 16	10	100
5S00I5N051820T	2.0	3/4" EK x 18	10	100
5S00I5N052020T	2.0	3/4" EK x 20	10	80
5S00I5N052022T	2.25	3/4" EK x 20	10	80

5S00.M4

VALVOLA A SFERA A PRESSARE
PRESS BALL VALVE

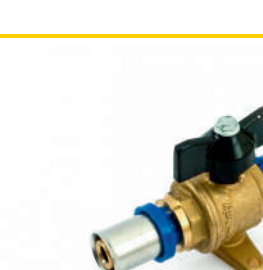

CODICE	+	Ø	◇	☐
5S00M4H162000T	2.0	16x16	8	48
5S00M4H202000T	2.0	20x20	6	36

5S00.M6

VALVOLA A SFERA A PRESSARE FEMMINA
FEMALE PRESS BALL VALVE



CODICE	+	Ø	◇	☐
5S00M6H041620T	2.0	1/2"x16	10	60
5S00M6H042020T	2.0	1/2"x20	10	60

5S00.M7

VALVOLA A SFERA A PRESSARE MASCHIO
MALE PRESS BALL VALVE



CODICE	+	Ø	◇	☐
5S00M7H041620T	2.0	1/2"x16	10	60
5S00M7H042020T	2.0	1/2"x20	10	60

Tutti i codici ø40-50-63 saranno sostituiti dai codici similari della linea Safe_Press ad esaurimento scorte.
All ø40-50-63 codes will be replaced by similar codes from the Safe_Press line one stocks are exhausted.



EWOPREX



Raccordi a pressare multiprofilo con trattamento galvanico e sistema LBP Multijaws press fittings with galvanic treatment and LBP system

I raccordi a pressare per tubo multistrato EWOPREX sono realizzati in ottone con speciale trattamento galvanico "STEEL LIKE TIN" e hanno la bussola in acciaio. Il trattamento galvanico "STEEL LIKE TIN" riduce i depositi di calcare, protegge dalla cessione di piombo, resiste alla corrosione e usura, annulla la dezincificazione e garantisce un'elevata potabilità dell'acqua.

Il sistema Leak Before Press (LBP) garantisce una perfetta esecuzione della pressata grazie alla caratteristica di segnalare la mancata o non completa pinzata da parte dell'operatore, riducendo così la possibilità di errore o dimenticanze che possono inficiare la tenuta dell'impianto nel tempo.

I raccordi EWOPREX, con il loro particolare disegno, possono essere serrati al tubo multistrato utilizzando ganasce con profilo H, TH, U.

La particolarità di avere un colore dell'anello di pressata diverso per ogni diametro consente un'immediata riconoscibilità della tipologia di tubo multistrato installato. I raccordi sono utilizzabili in impianti di adduzione di acqua calda e fredda per usi sanitari o di riscaldamento/raffrescamento ed in ogni tipo di installazione idraulica (commerciale, domestica, industriale e agricola).

EWOPREX multi-layer pipe press fittings are made of brass with a special "STEEL-LIKE TIN" electroplating and have a steel sleeve. The 'STEEL LIKE TIN' galvanic treatment reduces limescale deposits, protects against lead release, resists to corrosion and wear, counteracts dezincification and guarantees high water potability.

EWOPREX press fittings are equipped with LEAK BEFORE PRESS (LBP) system to detect water leak if the fitting is not pressed. This allows to easily detect the improper installation and eventually react promptly, thus reducing the possibility of error or forgetfulness that can affect the sealing of the system over time.

EWOPREX fittings have been designed and tested to be used with TH, H and U profile jaws.

The different colour of the insulation rings allows to easily identify the diameter and thickness of the pipe.

The fittings can be used in hot and cold water supply systems for sanitary or heating/cooling purposes and in any type of hydraulic installation (commercial, domestic, industrial and agricultural) and with non-aggressive fluids.









VANTAGGI

- Trattamento galvanico "STEEL LIKE TIN": assenza di porosità; riduzione drastica di deposito di calcare; resistenza alla corrosione e all'usura; permanenza della lucidità sul lungo periodo; elevata potabilità.
- Funzione LEAK BEFORE PRESS: massima sicurezza
- Multiprofilo TH, H, U
- Anello dielettrico con finestra di controllo della corretta posizione del tubo
- Anello colorato per un'identificazione immediata del diametro
- Materie prime impiegate di alta qualità [UBA LIST]
- Doppio O-Ring
- Ampia gamma
- Rintracciabilità del prodotto

ADVANTAGES

- "STEEL LIKE TIN" treatment: absence of porosity; drastic reduction of limescale deposits; resistance to corrosion and wear; long-lasting shine; high potability.
- "Leak Before Press" function: maximum safety
- Multi-profile TH, H, U
- Plastic insulation ring to prevent electrolytic corrosion, and with windows to check the correct insertion of pipe
- Coloured plastic insulation rings to identify pipe diameter and thickness
- Raw materials complying with UBA LIST
- Double O-Ring
- Wide range
- Product traceability

CAMPI DI APPLICAZIONI E PRESTAZIONI FIELDS OF APPLICATION

APPLICAZIONI APPLICATIONS		T. min.	T. max	T. di sistema T. of the system	Press.max Max. pressure
	acqua potabile drinking water	-20°C	+120°C	-20°C/+95°C	10 bar
	acqua calda sanitaria hot sanitary water	-20°C	+120°C	-20°C/+95°C	10 bar
	raffrescamento cooling	-20°C	+120°C	-20°C/+95°C	10 bar
	radiatori radiators	-20°C	+120°C	-20°C/+95°C	10 bar
	riscaldamento a pavimento floor heating	-20°C	+120°C	-20°C/+95°C	10 bar
	irrigazione irrigation	-20°C	+120°C	-20°C/+95°C	10 bar
	aria compressa compressed air	-20°C* -20°C	+120°C	-20°C/+95°C	10 bar
	-20°C: solo con liquido antigelo glicole in % max del 30% -20°C: with the use of glycol in a maximum percentage of 30%				

COMPONENTI E MATERIALI COMPONENTS AND MATERIALS

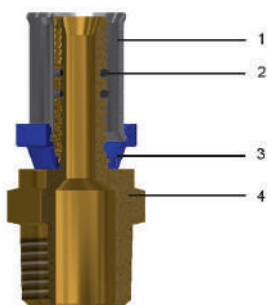

LEGENDA LEGEND	COMPONENTI COMPONENTS	MATERIALI MATERIALS
	1 Bussola Sleeve	Acciaio Inox - AISI 304 Stainless steel - AISI 304
	2 O-Ring	Elastomero per acqua potabile Elastomer for drinking water
	3 Ghiera Closing ring	Nylon
	4 Corpo Body	Ottone CW617N - UNI EN 12165 con trattamento galvanico STEEL LIKE TIN Brass CW617N - UNI EN 12165 with STEEL LIKE TIN treatment

LEAK BEFORE PRESS

LEAK BEFORE PRESS



Il sistema LEAK BEFORE PRESS garantisce un'installazione veloce e sicura dei raccordi a pressare in quanto consente la fuoriuscita di liquido laddove la giunzione non sia stata pressata. Quando il raccordo è pressato correttamente l'acqua circola nell'impianto e non si osservano perdite. Se il raccordo invece non è pressato, quando l'acqua circola nell'impianto, si notano le fuoriuscite. Grazie al sistema LEAK BEFORE PRESS è quindi possibile riconoscere velocemente i punti di mancata pressatura ed intervenire conseguentemente riducendo la possibilità di errore o dimenticanze che possono inficiare la tenuta dell'impianto nel tempo.

The LEAK BEFORE PRESS guarantees the fast and safe installation of press fittings as it allows the leakage of liquid where the joint has not been pressed. When the fitting is pressed correctly, the water circulates in the system and no leaks are observed. If, on the other hand, the fitting is not pressed, leaked water will be visible once it begins circulating in the system. Thanks to the LEAK-FREE system, it is then possible to quickly recognise the points not pressed and intervene accordingly, reducing the likelihood of error or forgetfulness that can affect the seal of the system over time.

NORMATIVE

- ISO 21003-3

I raccordi sono conformi alla norma ISO 21003-3: "Sistemi di tubazioni multistrato per le installazioni di acqua calda e fredda all'interno degli edifici."

- NORMA 1254-7-8

I raccordi sono conformi alla norma UNI EN 1254-7-8: "Rame e leghe di rame - Raccorderia idraulica - Parte 8: Raccordi a pressare per utilizzo con tubi di plastica e multistrato"

- UNI EN 10226-1

Tutte le filettature sono conformi alla norma UNI EN 10226-1: " Filettatura di tubazioni per accoppiamento a tenuta sul filetto"

- D.M. 174 (06/04/2004)

Materiali conformi al D.M. n° 174 del 06/04/2004 [Regolamento concernente i materiali e gli oggetti che possono essere utilizzati negli impianti fissi di captazione, trattamento, adduzione e distribuzione delle acque destinate al consumo umano

- Conforme a 4MS, UBA List (gruppo BC), DIN 50930/6 Dir. 2011/65/UE, 6C allegato III (RhOSII)

REGULATIONS

- ISO 21003-3

"Multilayer piping systems for hot and cold water supply installations inside building"

- 1254-7-8 REGULATION

Fittings comply with UNI EN 1254-7-8 law. Part 8: "Fittings with press ends for use with plastics and multilayer pipes".

- UNI EN 10226-1







Threads comply with UNI EN 10226-1 law: "Piping thread for coupling on the thread".

- D.M. 174 (06/04/2004)

The raw materials used are of high quality and comply with the Ministerial Decree N°174 dated 06/04/2004 concerning the materials and the items used in fixed installations for water collection, treatment and supply

- Comply with 4MS, UBA List (BC group), DIN 50930/6 Dir. 2011/65/UE, 6C attachment III (RhOSII).

CERTIFICAZIONI CERTIFICATIONS

STATO COUNTRY	CERTIFICAZIONE CERTIFICATION	STATO COUNTRY	CERTIFICAZIONE CERTIFICATION
			
			

ISTRUZIONI DI MONTAGGIO ASSEMBLY INSTRUCTIONS

Utilizzando un apposito utensile taglia tubi [codice TT50.00] eseguire un taglio perpendicolare all'asse del tubo.

Cut the pipe perpendicularly to its axis using an appropriate pipe-cutting tool [code TT500.00].



Calibrare e sbavare il tubo con apposito calibro [codice CS50.00; MA00.90], facendo attenzione ad eliminare eventuali trucioli residui.

Lo smusso interno deve essere compiuto su tutta la circonferenza.

Calibrate the pipe using special reamer [code CS50.00, MA00.90], removing possible residual chips. The pipe edge should be trimmed throughout the circumference.



Calzare il tubo sul portatubo del raccordo fino a battuta con l'anello plastico.

Il tubo è inserito correttamente quando è visibile attraverso tutte le finestre di ispezione della ghiera di plastica.

Insert the pipe into the pipe holder until the pipe stops at the plastic ring.

Check that the pipe is properly inserted and visible from all inspection windows.



Posizionare la pinza di pressatura e azionare il pulsante elettrico della macchina pressatrice.

Attenzione: il non corretto posizionamento della pinza potrebbe pregiudicare il funzionamento del sistema.

Place the pressing jaws and operate the electric button of the pressing machine.

An improper placing of the jaws could damage the proper system functioning.

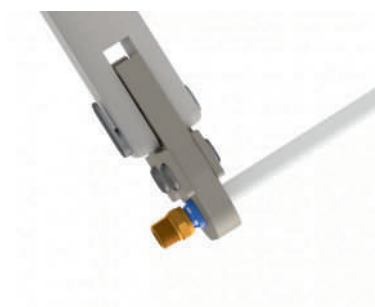

5T00.00

RACCORDO DIRITTO DOPPIO
DOUBLE STRAIGHT FITTING



CODICE	+	Ø	◇	☐
5T0000T162000A	2.0	16x16	10	100
5T0000T202000A	2.0	20x20	10	80
5T0000T162200A	2.25	16x16	10	100
5T0000T202500A	2.50	20x20	10	80
5T0000T263000A	3.00	26x26	5	40
5T0000T323000A	3.00	32x32	5	25
5T0000T403500A	3.50	40x40	2	14
5T0000T504000A	4.00	50x50	2	10
5T0000T634500A	4.50	63x63	-	4

5T00.01

RACCORDO DIRITTO MASCHIO
MALE STRAIGHT FITTING



CODICE	+	Ø	◇	☐
5T0001T041620A	2.00	16x1/2"	10	120
5T0001T051620A	2.0	16x3/4"	10	80
5T0001T042020A	2.0	20x1/2"	10	100
5T0001T052020A	2.0	20x3/4"	10	80
5T0001T041622A	2.25	16x1/2"	10	120
5T0001T051622A	2.25	16x3/4"	10	80
5T0001T042025A	2.50	20x1/2"	10	100
5T0001T052025A	2.50	20x3/4"	10	80
5T0001T042630A	3.00	26x1/2"	5	50
5T0001T052630A	3.00	26x3/4"	5	50
5T0001T102630A	3.00	26x1"	5	40
5T0001T103230A	3.00	32x1"	5	30
5T0001T124035A	3.50	40x1 1/4"	2	14
5T0001T145040A	4.00	50x1 1/2"	2	12
5T0001T206345A	4.50	63x2"	-	8

5T00.02RACCORDO DIRITTO MASCHIO
MALE STRAIGHT FITTING

CODICE	+	Ø	◇	☐
5T0002T041620A	2.0	16x1/2"	10	100
5T0002T051620A	2.0	16x3/4"	10	50
5T0002T042020A	2.0	20x1/2"	10	80
5T0002T052020A	2.0	20x3/4"	10	50
5T0002T041622A	2.25	16x1/2"	10	100
5T0002T051622A	2.25	16x3/4"	10	50
5T0002T042025A	2.50	20x1/2"	10	80
5T0002T052025A	2.50	20x3/4"	10	50
5T0002T042630A	3.00	26x1/2"	5	50
5T0002T052630A	3.00	26x3/4"	5	40
5T0002T102630A	3.00	26x1"	5	40
5T0002T103230A	3.00	32x1"	5	30
5T0002T124035A	3.50	40x1"1/4	2	14
5T0002T145040A	4.0	50x1"1/2"	2	10

5T00.03RACCORDO DIRITTO RIDOTTO
REDUCED STRAIGHT FITTING

CODICE	+	Ø	◇	☐
5T0003T665600A	2.0/2.0	20x16	10	100
5T0003T775600A	3.0/2.0	26x16	5	60
5T0003T776600A	3.0/2.0	26x20	5	50
5T0003T806600A	3.0/2.0	32x20	5	30
5T0003T675900A	2.50/2.25	20x16	10	100
5T0003T775900A	3.00/2.25	26x16	5	60
5T0003T776700A	3.00/2.50	26x20	5	50
5T0003T806700A	3.00/2.50	32x20	5	30
5T0003T807700A	3.00/3.00	32x26	5	30
5T0003T837700A	3.50/3.00	40x26	2	20
5T0003T838000A	3.50/3.00	40x32	-	14
5T0003T878000A	4.00/3.00	50x32	2	14
5T0003T878300A	4.00/3.50	50x40	2	10
5T0003T918300A	4.50/3.50	63x40	-	7
5T0003T918700A	4.50/4.00	63x50	-	6

5T00.10 RACCORDO A T
TEE



CODICE	+	Ø	◇	☐
5T0010T162000A	2.25	16x16x16	10	50
5T0010T202000A	2.0	20x20x20	10	30
5T0010T162200A	2.25	16x16x16	10	50
5T0010T202500A	2.50	20x20x20	10	30
5T0010T263000A	3.00	26x26x26	5	20
5T0010T323000A	3.00	32x32x32	5	10
5T0010T403500A	3.50	40x40x40	2	6
5T0010T504000A	4.00	50x50x50	2	4
5T0010T634500A	4.5	63x63x63	-	-

5T00.11 RACCORDO A T MASCHIO
MALE TEE



CODICE	+	Ø	◇	☐
5T0011T041620A	2.0	16x1/2"x16	10	50
5T0011T042020A	2.0	20x1/2"x20	10	40
5T0011T052020A	2.0	20x3/4"x20	10	30
5T0011T041622A	2.25	16x1/2"x16	10	60
5T0011T042025A	2.50	20x1/2"x20	10	40
5T0011T052025A	2.50	20x3/4"x20	10	30
5T0011T052630A	3.00	26x3/4"x26	5	25
5T0011T103230A	3.00	32x1"x32	5	15

5T00.12 RACCORDO A T FEMMINA
FEMALE TEE



CODICE	+	Ø	◇	☐
5T0012T041620A	2.0	16x1/2"x16	10	50
5T0012T042020A	2.0	20x1/2"x20	10	40
5T0012T052020A	2.0	20x3/4"x20	10	30
5T0012T041622A	2.25	16x1/2"x16	10	50
5T0012T042025A	2.50	20x1/2"x20	10	40
5T0012T052025A	2.50	20x3/4"x20	10	30
5T0012T042630A	3.00	26x1/2"x26	5	25
5T0012T052630A	3.00	26x3/4"x26	5	20
5T0012T102630A	3.00	26x1"x26	5	20
5T0012T103230A	3.00	32x1"x32	5	10
5T0012T124035A	3.50	40x1"1/4x40	2	8
5T0012T145040A	4.00	50x1"1/2x50	2	4
5T0012T106345A*	4.50	63x1"x63	-	3

*Disponibile senza trattamento

*Available without treatment

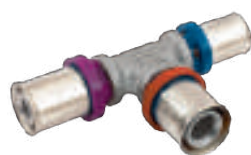
5T00.13RACCORDO A T RIDOTTO
REDUCED TEE

CODICE	+	Ø	◇	□
5T0013T566656A	2.00/2.00/2.00	16x20x16	10	40
5T0013T665656A	2.00/2.00/2.00	20x16x16	10	40
5T0013T665666A	2.00/2.00/2.00	20x16x20	10	40
5T0013T666656A	2.00/2.00/2.00	20x20x16	10	40
5T0013T667766A	2.00/3.00/2.00	20x26x20	5	20
5T0013T775656A	3.00/2.00/2.00	26x16x16	5	20
5T0013T775666A	3.00/2.00/2.00	26x16x20	5	20
5T0013T776666A	3.00/2.00/2.00	26x20x20	5	20
5T0013T806666A	3.00/2.00/2.00	32x20x20	5	10
5T0013T775677A	3.00/2.00/3.00	26x16x26	5	20
5T0013T776677A	3.00/2.00/3.00	26x20x26	5	20
5T0013T805680A	3.00/2.00/3.00	32x16x32	5	10
5T0013T806677A	3.00/2.00/3.00	32x20x26	5	15
5T0013T806680A	3.00/2.00/3.00	32x20x32	5	10
5T0013T777756A	3.00/3.00/2.00	26x26x16	5	20
5T0013T777766A	3.00/3.00/2.00	26x26x20	5	20
5T0013T808066A	3.00/3.00/2.00	32x32x20	5	10
5T0013T596759A	2.25/2.50/2.25	16x20x16	10	40
5T0013T675959A	2.50/2.25/2.25	20x16x16	10	40
5T0013T675967A	2.50/2.25/2.50	20x16x20	10	40
5T0013T676759A	2.50/2.50/2.25	20x20x16	10	40
5T0013T677767A	2.50/3.00/2.50	20x26x20	5	20
5T0013T775959A	3.00/2.25/2.25	26x16x16	5	20
5T0013T775967A	3.00/2.25/2.50	26x16x20	5	20
5T0013T775977A	3.00/2.25/3.00	26x16x26	5	20
5T0013T805980A	3.00/2.25/3.00	32x16x32	5	10
5T0013T776767A	3.00/2.50/2.50	26x20x20	5	20
5T0013T806767A	3.00/2.50/2.50	32x20x20	5	15

5T00.13RACCORDO A T RIDOTTO
REDUCED TEE

CODICE	+	Ø	◇	□
5T0013T776777A	3.00/2.50/3.00	26x20x26	5	20
5T0013T806780A	3.00/2.50/3.00	32x20x32	5	10
5T0013T806777A	3.00/2.50/3.00	32x20x26	5	15
5T0013T777759A	3.00/3.00/2.25	26x26x16	5	20
5T0013T777767A	3.00/3.00/2.50	26x26x20	5	20
5T0013T808067A	3.00/3.00/2.50	32x32x20	5	10
5T0013T778077A	3.00/3.00/3.00	26x32x26	5	10
5T0013T807777A	3.00/3.00/3.00	32x26x26	5	10
5T0013T807780A	3.00/3.00/3.00	32x26x32	5	10
5T0013T808077A	3.00/3.00/3.00	32x32x26	5	10
5T0013T837780A	3.50/3.00/3.00	40x26x32	2	8
5T0013T838080A	3.50/3.00/3.00	40x32x32	2	8
5T0013T837783A	3.50/3.00/3.50	40x26x40	2	6
5T0013T838083A	3.50/3.00/3.50	40x32x40	2	6
5T0013T877787A	4.00/3.00/4.00	50x26x50	-	4
5T0013T878087A	4.00/3.00/4.00	50x32x50	2	4
5T0013T878387A	4.00/3.50/4.00	50x40x50	-	4
5T0013T918391A	4.50/3.50/4.50	63x40x63	-	2
5T0013T918791A	4.50/4.00/4.50	63x50x63	-	2

5T00.20 ANGOLO DOPPIO
DOUBLE ELBOW



CODICE	+	Ø	◇	☐
5T0020T162000A	2.0	16x16	10	80
5T0020T202000A	2.0	20x20	10	60
5T0020T162200A	2.25	16x16	10	80
5T0020T202500A	2.50	20x20	10	60
5T0020T263000A	3.00	26x26	5	40
5T0020T323000A	3.00	32x32	5	20
5T0020T403500A	3.50	40x40	-	10
5T0020T504000A	4.00	50x50	-	6
5T0020T634500A	4.50	63x63	-	3

5T00.I5 RACCORDO DIRITTO SEDE CONICA O-RING CON
GIRELLO
STRAIGHT FITTING WITH LOOSE NUT AND
EUROCONE



CODICE	+	Ø	◇	☐
5T00I5T041620A	2.0	16x1/2"	10	100
5T00I5T051620A	2.0	16x3/4"	10	100
5T00I5T042020A	2.0	20x1/2"	10	100
5T00I5T052020A	2.0	20x3/4"	10	80
5T00I5T041622A	2.25	16x1/2"	10	100
5T00I5T051622A	2.25	16x3/4"	10	100
5T00I5T042025A	2.50	20x1/2"	10	100
5T00I5T052025A	2.50	20x3/4"	10	80

5T00.21 ANGOLO MASCHIO
MALE ELBOW



CODICE	+	Ø	◇	☐
5T0021T041620A	2.0	16x1/2"	10	80
5T0021T042020A	2.0	20x1/2"	10	60
5T0021T052020A	2.0	20x3/4"	10	60
5T0021T041622A	2.25	16x1/2"	10	80
5T0021T042025A	2.50	20x1/2"	10	60
5T0021T052025A	2.50	20x3/4"	10	60
5T0021T052630A	3.00	26x3/4"	5	40
5T0021T103230A	3.00	32x1"	5	20
5T0021T124035A	3.50	40x1 1/4"	2	12
5T0021T145040A	4.00	50x1 1/2"	2	8
5T0021T206345A	4.50	63x2"	-	4

5T00.22

ANGOLO FEMMINA
FEMALE ELBOW



CODICE	+	Ø	◇	☐
5T0022T041620A	2.0	16x1/2"	10	80
5T0022T042020A	2.0	20x1/2"	10	60
5T0022T052020A	2.0	20x3/4"	10	50
5T0022T041622A	2.25	16x1/2"	10	80
5T0022T042025A	2.50	20x1/2"	10	60
5T0022T052025A	2.50	20x3/4"	10	50
5T0022T042630A	3.00	26x1/2"	5	30
5T0022T052630A	3.00	26x3/4"	5	30
5T0022T102630A	3.00	26x1"	5	20
5T0022T103230A	3.00	32x1"	5	20
5T0022T124035A	3.50	40x1"1/4	2	12
5T0022T145040A	4.0	50x1"1/2	2	8

5800.07

PROLUNGA NICHELATA IN RAME
NICKEL-PLATED COPPER EXTENSION



CODICE	Ø
580007N041400H	1/2"x14

5T00.23

ATTACCO A MURO 3 FORI
WALLPLATE ELBOW WITH 3 HOLES



CODICE	+	Ø	◇	☐
5T0023T041620A	2.0	16x1/2"	10	40
5T0023T045635A*	2.0	16x1/2"	10	50
5T0023T042020A	2.0	20x1/2"	10	40
5T0023T052020A	2.0	20x3/4"	10	30
5T0023T041622A	2.25	16x1/2"	10	40
5T0023T045935A*	2.25	16x1/2"	10	50
5T0023T042025A	2.50	20x1/2"	10	40
5T0023T052025A	2.50	20x3/4"	10	30
5T0023T052630A	3.00	26x3/4"	5	20

*H=35

*H=35

5T00.E3

DOPPIO ATTACCO UNIVERSALE
DOUBLE UNIVERSAL CONNECTION



CODICE	+	Ø	◇	☐
5T00E3H041622A	2.25	16x1/2"	5	15
5T00E3H042025A	2.5	20x1/2"	5	15

Attacco universale per radiatori/termoarredi interasse 50mm. Attacco 1/2" predisposto per inserimento prolunga nichelata in rame dn14.

Universal coupling for radiators/heaters 50 mm centre distance. 1/2" connection prepared for insertion of nickel-plated copper extension pipe dn14

5T00.34 ATTACCO A MURO DOPPIO CON FLANGIA 3 FORI
DOUBLE WALLPLATE ELBOW WITH 3 HOLES



CODICE	+	Ø	◇	☐
5T0034T160416A	2.0	16x1/2"	5	15
5T0034T200420A	2.0	20x1/2"	5	15
5T0034T041622A	2.25	16x1/2"	5	15
5T0034T042025A	2.50	20x1/2"	5	15

Fino ad esaurimento scorte, poi sostituito dal Safe_Press 5T00.34

While stocks last, then replaced by Safe_Press 5T00.34.

AC00.80 STAFFA SAGOMATA PER FISSAGGIO A MURO ART
5T00.23 E 5T00.34 COMPLETO DI VITI DI FISSAGGIO
SECTIONAL BRACKET FOR WALL FIXING ART 5T00.23
AND 5T00.34 COMPLETE WITH FIXING SCREWS

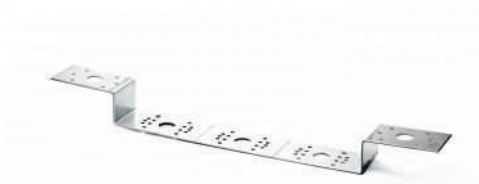

CODICE	+	☐
AC0080H75B506H	1.5 mm	12
AC0080H75B5P6H	2.5 mm	12

Staffa sagomata per fissaggio a muro per raccordo gomito femmina con flangia, in acciaio zincato 1.5 mm/2.5 mm, profondità sagomatura 30 mm, simmetrica, interasse di posa 75 - 150 mm, inclinazioni possibili 0°/7.5°/15°. Applicabile su qualsiasi supporto (cartongesso, legno, muratura). Lunghezza 370 mm. Completa di viti per fissaggio raccordi.

Sectionable bracket with screws. Moulded bracket for female elbow with flange fastening to wall, zinc-plated 1.5/2.5 mm, mould depth 30 mm, symmetrical, laying distance center to center 75 - 150 mm, possible grade 0°/7.5°/15°. It is suitable for any support (plasterboard, wood, masonry). Length 370 mm. Together with screws for fittings fastening.

5T00.C7 RACCORDO DIRITTO SEDE PIANA CON GIRELLO
STRAIGHT FITTING WITH LOOSE NUT AND FLAT
WASHER



CODICE	+	Ø	◇	☐
5T00C7T041620A	2.0	16x1/2"	10	100
5T00C7T051620A	2.0	16x3/4"	10	60
5T00C7T042020A	2.0	20x1/2"	10	60
5T00C7T052020A	2.0	20x3/4"	10	60
5T00C7T041622A	2.25	16x1/2"	10	60
5T00C7T051622A	2.25	16x3/4"	10	60
5T00C7T042025A	2.50	20x1/2"	10	100
5T00C7T052025A	2.50	20x3/4"	10	60
5T00C7T052630A	3.00	26x3/4"	5	60
5T00C7T102630A	3.00	26x1"	5	60
5T00C7T123230A	3.00	32x1 1/4"	5	25

Ad esaurimento: disponibili poi in ottone non trattato
*Utilizzabile con attacchi Eurocono tramite adattatore a sede piana

While stocks last, then available without treatment.
*It can be used with Euroconus connections via flat seat adapter

5T00.G3

ANGOLO CON DADO GIREVOLE E SEDE PIANA
ELBOW WITH LOOSE NUT



CODICE	+	Ø	◇	☐
5T00G3T041620A	2.0	16x1/2"	10	50
5T00G3T042020A	2.0	20x1/2"	10	50
5T00G3T052020A	2.0	20x3/4"	10	50
5T00G3T041622A	2.25	16x1/2"	10	50
5T00G3T042025A	2.50	20x1/2"	10	50
5T00G3T052025A	2.50	20x3/4"	10	50
5T00G3T052630A	3.00	26x3/4"	5	30

Ad esaurimento: disponibili poi in ottone non trattato
*Utilizzabile con attacchi Eurocono tramite adattatore a sede piana

While stocks last, then available without treatment.
*It can be used with Euroconus connections via flat seat adapter

6R00.76

VITONE COMPLETO PER RUBINETTO INCASSO
COMPLETE SHUT FOR IN-WALL TAP

**CODICE**

6R0076T042219H

PR5T.75

VALVOLA A SFERA A INCASSO
IN-WALL BALL VALVE



CODICE	+	Ø	◇	☐
PR5T75T162000A	2.0	16x16	6	12
PR5T75T202000A	2.0	20x20	6	12
PR5T75T162200A	2.25	16x16	-	12
PR5T75T202500A	2.5	20x20	-	12

5T00.74

VALVOLA AD INCASSO CON VITONE ESTRAIBILE
BUILT-IN VALVE WITH REMOVABLE SCREW



CODICE	+	Ø	◇	☐
5T0074T162000A	2.0	16x16	6	12
5T0074T202000A	2.0	20x20	6	12
5T0074T162200A	2.25	16x16	6	12
5T0074T202500A	2.5	20x20	6	12

5S00.43 PROLUNGA PER VALVOLA A SFERA A INCASSO
EXTENSION FOR IN-WALL BALL-VALVE



CODICE



5S0043H221900H

100

5S00.84 SET LEVA E ROSONE PER VALVOLA A INCASSO
PLATE AND LEVER FOR BUILT-IN VALVE



CODICE

5S0084C081602H

5S00.84 BLU SET MANOPOLA E ROSONE PER VALVOLA A
INCASSO
PLATE AND RED HANDLE FOR BUILT-IN VALVE



CODICE

5S0084C0816B1H

**5S00.84
ROSSO** SET MANOPOLA E ROSONE PER VALVOLA A
INCASSO
PLATE AND RED HANDLE FOR BUILT-IN VALVE



CODICE

5S0084C0816R1H

5W00.84 SET CAPPUCCIO/ROSONE
SET CAP/ROSETTE



CODICE



5W0084C081600H

50



SISTEMI PER TUBO
MULTISTRATO

EWOPREX

RACCORDI MULTIPROFILO
CON TRATTAMENTO GALVANICO E
SISTEMA L.B.P

MULTIJAWS PRESS FITTINGS
WITH GALVANIC TREATMENT AND L.B.P SYSTEM



TRIDENT

SERIE 5G00 LINE 5G00

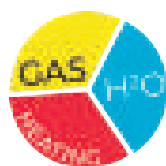

Raccordi a pressare multiprofilo per acqua, gas e riscaldamento Multijaws press fittings for water, gas and heating

TRIDENT è l'esclusiva serie di raccordi a pressare per tubo multistrato con triplice utilizzo: ACQUA, GAS e RISCALDAMENTO. I raccordi sono utilizzabili in impianti di adduzione di acqua calda e fredda per usi sanitari o di riscaldamento/raffrescamento, in impianti di adduzione gas per usi domestici alimentati da rete di distribuzione, bombola o serbatoi fissi di GPL e in ogni tipo di installazione idraulica (commerciale, domestica, industriale e agricola) e in linea di massima con fluidi non aggressivi.

I raccordi della serie 5G00 sono stati studiati e testati per essere utilizzati indifferentemente con i profili di pinzatura TH, H, U. La serie 5G00 è composta da raccordi a pressare per tubo multistrato con corpo in ottone e bussola in acciaio.

La geometria del raccordo consente un ottimo accoppiamento tra tubo e raccordo in seguito alla pressatura e le finestre sul portabussola permettono di verificare la corretta inserzione del tubo. Due O-Ring garantiscono la tenuta e l'affidabilità del prodotto nel tempo.

Essendo la tipologia di giunzione irreversibile [non smontabile]:

- per utilizzo acqua è possibile posizionare il raccordo sottotraccia, avendo cura di proteggerlo con materiali idonei (vedere attestato di conformità nr 0128/15)
- per utilizzo gas è possibile posizionare il raccordo sottotraccia, avendo cura di collocarlo in pozzetti ispezionabili.

TRIDENT is the exclusive and unique line of press fittings for multilayer pipe suitable for WATER, GAS and HEATING. Fittings are suitable for cold or hot water supply for sanitary or heating systems, installations of gas supply for residential use from distribution network or LPG cylinders or tanks to be realized with metal-plastic pipes, and for any kind of sanitary installation such as domestic, commercial, industry and farming and with non-aggressive fluids. Fittings of line 5G00 TRIDENT have been designed and tested to be used with TH, H, U crimper profiles. Fittings body is made of brass, while the sleeve is made of AISI 304 stainless steel.

The geometry of the fitting allows an excellent coupling between pipe and fitting after pressing and the plastic insulation ring windows allow to check the correct insertion of the pipe. Two O-rings guarantee the seal and reliability over time.

Since the connecting type is irreversible (it is not possible to disassemble):

- *WATER INSTALLATIONS: it is possible to place the fittings chased in, taking care of protecting it from non-suitable materials (see certificate of conformity nr 0128/15)*
- *GAS INSTALLATIONS: it is possible to place the fitting chased in, taking care to place it inside an inspectable sump unit.*









VANTAGGI

- Triplice utilizzo: ACQUA, GAS, RISCALDAMENTO
- Multiprofilo
- Doppio O-Ring certificato acqua e gas
- Semplificazione nella gestione dei codici e riduzione del magazzino
- Maggiore sicurezza in cantiere (1 solo prodotto per acqua e gas)
- Bussola con stick colorato per individuazione immediata applicazioni e dimensioni
- Anello dielettrico con finestra di controllo della corretta posizione del tubo
- Materie prime impiegate di alta qualità [UBA LIST]
- Conforme alla normativa UNI 11344
- Rintracciabilità del prodotto garantita dal datario impresso sul corpo del raccordo
- Filetto conico ISO 7/1
- Ampia gamma [dal Ø 16 al Ø 32]

ADVANTAGES





- *Universal fittings: WATER, GAS, HEATING*
- *Multitool*
- *Certified O-Ring for water and gas*
- *Simplification of code management and halving of stock*
- *No risk of confusion gas / water and vice versa on construction site*
- *Sleeve with colored stick for immediate identification of applications and dimensions*
- *Plastic insulation ring to prevent electrolytic corrosion, and with windows to check the correct insertion of pipe*
- *Raw materials complying with UBA LIST*
- *Comply with UNI 11344 standards*
- *Product traceability guaranteed by the date stamped on the body of the fitting*
- *ISO 7/1 threads*
- *Wide range [from Ø 16 to Ø 32]*

CAMPI DI APPLICAZIONI E PRESTAZIONI FIELDS OF APPLICATION

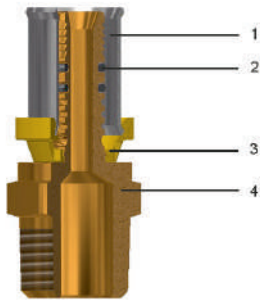

APPLICAZIONI APPLICATIONS	T. min.	T. max	T.sistema System T.	Press.max Max. pressure
 acqua potabile drinking water	-20°C	+120°C	-20°C/+95°C	10 bar
 acqua calda sanitaria sanitary hot water	-20°C	+120°C	-20°C/+95°C	10 bar
 raffrescamento cooling	-20°C	+120°C	-20°C/+95°C	10 bar
 radiatori radiators	-20°C	+120°C	-20°C/+95°C	10 bar
 riscaldamento a pavimento floor heating	-20°C	+120°C	-20°C/+95°C	10 bar
 aria compressa compressed air	-20°C	+120°C	-20°C/+95°C	10 bar
 irrigazione irrigation	-20°C	+120°C	-20°C/+95°C	10 bar
 gas gas	-20°C	+70°C	-20°C/+70°C	0.5 MOP
 -20°C: solo con liquido antigelo glicole in % max del 30% -20°C: with the use of glycol in a maximum percentage of 30%				

COMPONENTI E MATERIALI COMPONENTS AND MATERIALS



LEGENDA LEGEND	COMPONENTI COMPONENTS	MATERIALI MATERIALS
	1 Bussola Sleeve	Acciaio Inox - AISI 304 Stainless steel - AISI 304
	2 O-Ring	Elastomero per acqua potabile e gas Elastomer for drinking water and gas
	3 Ghiera Closing ring	Nylon
	4 Corpo Body	Ottone CW617N - UNI EN 12165 Brass CW617N - UNI EN 12165

PROFILI DI PINZATURA PRESSING PROFILES

Ø		TH		H		U
ACQUA WATER						
16x2.0		TH		H		U
20x2.0		TH		H		U
26x3.0		TH		H		-
32x3.0		TH		H		U
GAS						
16x2.0		TH		H		U
20x2.0		TH		H		U
26x3.0		TH		H		-
32x3.0		TH		H		U

NORMATIVE

- ISO 21003-3
I raccordi sono conformi alla norma ISO 21003-3: "Sistemi di tubazioni multistrato per le installazioni di acqua calda e fredda all'interno degli edifici."
- UNI EN 1254-7-8
I raccordi sono conformi alla norma UNI EN 1254-7-8: "Rame e leghe di rame - Raccorderia idraulica - Parte 8: Raccordi a pressare per utilizzo con tubi di plastica e multistrato".
- UNI EN 10226-1
Tutte le filettature sono conformi alla norma UNI EN 10226-1: "Filettatura di tubazioni per accoppiamento a tenuta sul filetto".
- D.M. 174 (06/04/2004)
Materiali conformi al D.M. n° 174 del 06/04/2004

REGULATIONS

- ISO 21003-3
"Multilayer piping systems for hot and cold water supply installations inside building"
- UNI EN 1254-7-8
Fittings comply with UNI EN 1254-7-8 law. Part 8: "Fittings with press ends for use with plastics and multilayer pipes".
- UNI EN 10226-1
Threads comply with UNI EN 10226-1 law: "Piping thread for coupling on the thread".
- D.M. 174 (06/04/2004)
Raw materials used are of high quality and comply with the Ministerial Decree N°174 dated 06/04/2004 concerning the materials and the items used in fixed installations for water collection, treatment and supply.
- UNI 7129

[Regolamento concernente i materiali e gli oggetti che possono essere utilizzati negli impianti fissi di captazione, trattamento, adduzione e distribuzione delle acque destinate al consumo umano].

- UNI 7129

I raccordi sono conformi alla norma UNI 7129: "Impianti a gas per uso domestico e similare alimentati da rete di distribuzione - Progettazione, installazione e messa in servizio".

- UNI 11344

I raccordi sono conformi alla norma UNI 11344: "Sistemi di tubazioni multistrato metallo-plastici e raccordi per il trasporto di combustibili gassosi per impianti interni".

- Conforme a 4MS, UBA List (gruppo BC), DIN 50930/6 Dir. 2011/65/UE, 6C allegato III (RhOSII)









Compliant with UNI 7129 law: "Gas plants for domestic and similar use supplied by network".

- UNI 11344

Compliant with UNI 11344 standard specifies the characteristics of multilayer pipes and fittings suitable for the construction of internal systems for the transport of gaseous fuels of the I, II and III families.

- Comply with 4MS, UBA List (BC group), DIN 50930/6 Dir. 2011/65/UE, 6C attachment III (RhOSII).

CERTIFICAZIONI CERTIFICATIONS

STATO COUNTRY	CERTIFICAZIONE CERTIFICATION	STATO COUNTRY	CERTIFICAZIONE CERTIFICATION	STATO COUNTRY	CERTIFICAZIONE CERTIFICATION
					
					

ISTRUZIONI DI MONTAGGIO ASSEMBLY INSTRUCTIONS

Utilizzando un apposito utensile taglia tubi [codice TT50.00] eseguire un taglio perpendicolare all'asse del tubo.

Cut the pipe perpendicularly to its axis using an appropriate pipe-cutting tool [code TT50.00].



Calibrare e sbavare il tubo con apposito calibro [codice CS50.00; MA00.90], facendo attenzione ad eliminare eventuali trucioli residui. Lo smusso interno deve essere compiuto su tutta la circonferenza.

Calibrate the pipe using special reamer [code CS50.00, MA00.90], removing possible residual chips. The pipe edge should be trimmed throughout the circumference.



Calzare il tubo sul portatubo del raccordo fino a battuta con l'anello plastico. Il tubo è inserito correttamente quando è visibile attraverso tutte le finestre di ispezione della ghiera di plastica

Insert the pipe into the pipe holder until the pipe stops at the plastic ring. Check that the pipe is properly inserted and visible from all inspection windows.

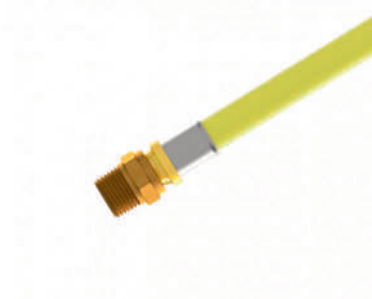

Posizionare la pinza di pressatura e azionare il pulsante elettrico della macchina pressatrice. Attenzione: lo scorretto posizionamento della pinza potrebbe pregiudicare il funzionamento del sistema.

N.B. Raccordi con terminali filettati: posizionare sul raccordo uno strato di materiale isolante (uso canapa sconsigliato) per consentire una miglior tenuta sull'attacco. Verificare che non vi sia eccedenza di materiale aggiunto per prevenire possibili rotture per l'eccessivo serraggio.

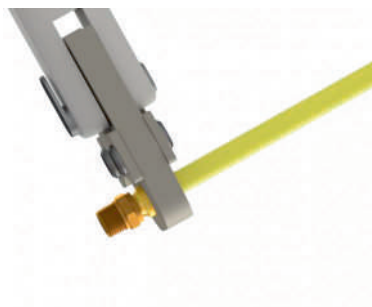

Place the pressing jaws and operate the electric button of the pressing machine. An improper placing of the jaws could damage the proper system functioning

N.B. Threaded fittings: place over the fitting a lay of insulating material (no hemp) in order to obtain a better tightness on the coupling. Please check if there isn't a surplus of above mentioned coat, in order to prevent possible breakings caused by excessive screwing.

5G00.00RACCORDO DIRITTO DOPPIO
DOUBLE STRAIGHT FITTING

CODICE	+	Ø	◇	☐
5G0000H162000T	2.0	16x2.0	10	100
5G0000H202000T	2.0	20x2.0	10	70
5G0000H263000T	3.0	26x3.0	5	40
5G0000H323000T	3.0	32x3.0	5	25

5G00.01RACCORDO DIRITTO MASCHIO
MALE STRAIGHT FITTING

CODICE	+	Ø	◇	☐
5G0001H041620T	2.0	1/2"x16	10	120
5G0001H042020T	2.0	1/2"x20	10	100
5G0001H042630T	3.0	1/2"x26	5	50
5G0001H051620T	2.0	3/4"x16	10	90
5G0001H052020T	2.0	3/4"x20	10	80
5G0001H052630T	3.0	3/4"x26	5	50
5G0001H102630T	3.0	1"x26	5	40
5G0001H103230T	3.0	1"x32	5	40

5G00.02RACCORDO DIRITTO FEMMINA
FEMALE STRAIGHT FITTING

CODICE	+	Ø	◇	☐
5G0002H041620T	2.0	1/2"x16	10	100
5G0002H042020T	2.0	1/2"x20	10	80
5G0002H042630T	3.0	1/2"x26	5	50
5G0002H051620T	2.0	3/4"x16	10	50
5G0002H052020T	2.0	3/4"x20	10	50
5G0002H052630T	3.0	3/4"x26	5	40
5G0002H102630T	3.0	1"x26	5	40
5G0002H103230T	3.0	1"x32	5	30

5G00.03RACCORDO DIRITTO RIDOTTO
REDUCED STRAIGHT FITTING

CODICE	+	Ø	◇	☐
5G0003H665600T	2.0/2.0	20x16	10	100
5G0003H775600T	3.0/2.0	26x16	5	40
5G0003H776600T	3.0/2.0	26x20	5	40
5G0003H806600T	3.0/2.0	32x20	5	30
5G0003H807700T	3.0/3.0	32x26	5	30

5G00.10 RACCORDO A T
TEE



CODICE	+	Ø	◇	☐
5G0010H162000T	2.0	16x16x16	10	50
5G0010H202000T	2.0	20x20x20	10	40
5G0010H263000T	3.0	26x26x26	5	20
5G0010H323000T	3.0	32x32x32	5	10

5G00.11 RACCORDO A T MASCHIO
MALE TEE



CODICE	+	Ø	◇	☐
5G0011H041620T	2.0	16x1/2"x16	10	60
5G0011H042020T	2.0	20x1/2"x20	10	40
5G0011H052020T	2.0	20x3/4"x20	10	30
5G0011H052630T	3.0	26x3/4"x26	5	25
5G0011H103230T	3.0	32x1"x32	5	10

5G00.12 RACCORDO A T FEMMINA
FEMALE TEE



CODICE	+	Ø	◇	☐
5G0012H041620T	2.0	16x1/2"x16	10	50
5G0012H042020T	2.0	20x1/2"x20	10	40
5G0012H042630T	3.0	26x1/2"x26	5	30
5G0012H052020T	2.0	20x3/4"x20	10	30
5G0012H052630T	3.0	26x3/4"x26	5	25
5G0012H102630T	3.0	26x1"x26	5	20
5G0012H103230T	3.0	32x1"x32	5	10

5G00.13RACCORDO A T RIDOTTO
REDUCED TEE

CODICE	+	Ø	◇	□
5G0013H566656T	2.0/2.0/2.0	16x20x16	10	40
5G0013H665656T	2.0/2.0/2.0	20x16x16	10	40
5G0013H665666T	2.0/2.0/2.0	20x16x20	10	40
5G0013H666656T	2.0/2.0/2.0	20x20x16	10	40
5G0013H667766T	2.0/3.0/2.0	20x26x20	5	20
5G0013H775656T	3.0/2.0/2.0	26x16x16	5	20
5G0013H775666T	3.0/2.0/2.0	26x16x20	5	20
5G0013H775677T	3.0/2.0/3.0	26x16x26	5	20
5G0013H776666T	3.0/2.0/2.0	26x20x20	5	20
5G0013H776677T	3.0/2.0/3.0	26x20x26	5	20
5G0013H777756T	3.0/3.0/2.0	26x26x16	5	20
5G0013H777766T	3.0/3.0/2.0	26x26x20	5	20
5G0013H778077T	3.0/3.0/3.0	26x32x26	5	15
5G0013H805680T	3.0/2.0/3.0	32x16x32	5	10
5G0013H806666T	3.0/2.0/2.0	32x20x20	5	10
5G0013H806677T	3.0/2.0/3.0	32x20x26	5	15
5G0013H806680T	3.0/2.0/3.0	32x20x32	5	10
5G0013H807777T	3.0/3.0/3.0	32x26x26	5	10
5G0013H807780T	3.0/3.0/3.0	32x26x32	5	10
5G0013H808066T	3.0/3.0/2.0	32x32x20	5	10

5G00.20ANGOLO DOPPIO
DOUBLE ELBOW

CODICE	+	Ø	◇	□
5G0020H162000T	2.0	16x16	10	100
5G0020H202000T	2.0	20x20	10	60
5G0020H263000T	3.0	26x26	5	30
5G0020H323000T	3.0	32x32	5	20

5G00.21ANGOLO MASCHIO
MALE ELBOW

CODICE	+	Ø	◇	□
5G0021H041620T	2.0	1/2"x16	10	80
5G0021H042020T	2.0	1/2"x20	10	60
5G0021H052020T	2.0	3/4"x20	10	60
5G0021H052630T	3.0	3/4"x26	5	40
5G0021H102630T	3.0	1"x26	5	25
5G0021H103230T	3.0	1"x32	5	20

5G00.22 ANGOLO FEMMINA
FEMALE ELBOW



CODICE	+	Ø	◇	📦
5G0022H041620T	2.0	1/2"x16	10	80
5G0022H042020T	2.0	1/2"x20	10	60
5G0022H042630T	3.0	1/2"x26	5	30
5G0022H052020T	2.0	3/4"x20	10	50
5G0022H052630T	3.0	3/4"x26	5	30
5G0022H102630T	3.0	1"x26	5	25
5G0022H103230T	3.0	1"x32	5	25

5G00.23 ATTACCO A MURO CON FLANGIA 3 FORI
WALLPLATE ELBOW WITH 3 HOLES



CODICE	+	Ø	◇	📦
5G0023H041620T	2.0	1/2"x16 H47	10	40
5G0023H042020T	2.0	1/2"x20 H49	10	40
5G0023H052020T	2.0	3/4"x20 H52	10	30
5G0023H052630T	3.0	3/4"x26 H52	5	25

5G00.C7 RACCORDO DIRITTO SEDE PIANA CON GIRELLO E
GUARNIZIONE
STRAIGHT FITTING WITH LOOSE NUT AND FLAT
WASHER



CODICE	+	Ø	◇	📦
5G00C7H041620T	2.0	1/2"x16	10	100
5G00C7H042020T	2.0	1/2"x20	10	100
5G00C7H051620T	2.0	3/4"x16	10	100
5G00C7H052020T	2.0	3/4"x20	10	60
5G00C7H052630T	3.0	3/4"x26	5	60
5G00C7H102630T	3.0	1"x26	5	60

5G00.G3 ANGOLO DADO GIREVOLE E SEDE PIANA CON
GUARNIZIONE
ELBOW WITH LOOSE NUT AND FLAT SURFACE



CODICE	+	Ø	◇	📦
5G00G3H052020T	2.0	3/4"x20	10	50
5G00G3H052630T	3.0	3/4"x26	5	30

5G00.I5

RACCORDO DIRITTO SEDE CONICA O-RING CON GIRELLO- SOLO USO GAS

STRAIGHT FITTING WITH LOOSE NUT AND CONICAL CONNECTION - FOR GAS



CODICE	+	i	Ø	◇	☐
5G00I5H051620T	2.0	solo gas	3/4"x16	10	100
5G00I5H052020T	2.0	solo gas	3/4"x20	10	80
5G00I5H052630T	3.0	solo gas	3/4"x26	5	60
5G00I5H112630T	3.0	solo gas	1"1/8x26	5	60
5G00I5H113230T	3.0	solo gas	1"1/8x32	5	25

5F00.N6

VALVOLA DIRITTA CON PRESA DI PRESSIONE SEDE CONICA PER ART. 5G00.I5

ANGLE VALVE WITH PRESSURE PLUG - TAPER END FOR ART. 5G00.I5



CODICE	i	Ø	☐
5F00N6H100000H	-	1"	6
5F00N6H100KEYH	Con chiave	1"	6

5F00.N7

VALVOLA DIRITTA CON PRESA DI PRESSIONE SEDE CONICA PER ART. 5G00.I5

ANGLE VALVE WITH PRESSURE PLUG - TAPER END FOR ART. 5G00.I5



CODICE	i	Ø	☐
5F00N7H100000H	-	1"	8
5F00N7H100KEYH	Con chiave	1"	8

5F00.N8

KIT PRESA DI PRESSIONE SEDE CONICA PER ART. 5G00.I5

PRESSURE PLUG KIT - TAPER END FOR ART. 5G00.I5



CODICE	Ø	◇
5F00N8H020000H	1/4"	5

5F00.N9

ANGOLO CON DISPOSITIVO DI SICUREZZA

ANGLE WITH FIRE - SAFE DEVICE



CODICE	Ø	☐
5F00N9H040000H	1/2"	30

5F00.01 VALVOLA DIRITTA CON DISPOSITIVO DI SICUREZZA
STRAIGHT VALVE WITH FIRE-SAFE DEVICE

CODICE	Ø	
5F0001H040000H	1/2"	20

5F00.02 VALVOLA A SQUADRA CON DISPOSITIVO DI
SICUREZZA
ELBOW VALVE WITH SAFETY DISPOSAL

CODICE	Ø	
5F0002H040000H	1/2"	20



SISTEMI PER TUBO
MULTISTRATO

TRIDENT

RACCORDI A PRESSARE MULTIPROFILO
PER ACQUA, GAS, RISCALDAMENTO
PRESS FITTINGS FOR
GAS, HEATING AND WATER



COMPREX

SERIE 5300

LINE 5300



Raccordi a compressione con ogiva tagliata

Compression fittings with cut brass olive

La serie 5300 è composta da raccordi a compressione con ogiva per tubo multistrato. I raccordi sono utilizzabili in impianti di adduzione di acqua calda e fredda per usi sanitari o di riscaldamento/raffrescamento, in ogni tipo di installazione idraulica (commerciale, domestica, industriale e agricola) e in linea di massima con fluidi non aggressivi.

Il serraggio meccanico del raccordo e la compressione degli O-Ring del portatubo garantiscono la tenuta.

Brass olive compression fittings for multilayer pipe (line 5300) are suitable for hot and cold water supply in sanitary and heating installations and for any kind of sanitary installation such as domestic, commercial, industry and farming. They can be used with any type of non-corrosive fluid.

The seal is guaranteed by the mechanical tightening of the fitting and the compression of the O-Ring of the pipe holder.







VANTAGGI

- Ampia gamma
- Per acqua potabile e riscaldamento
- Approvato DVGW
- Materie prime impiegate di alta qualità [UBA LIST]
- Nichelatura non a contatto con l'acqua

ADVANTAGES

- Wide range
- For drinking water and heating
- DVGW certified
- Raw materials complying with UBA LIST
- No contact between nickel and water

CAMPI DI APPLICAZIONI E PRESTAZIONI FIELDS OF APPLICATION

APPLICAZIONI APPLICATIONS	T. min.	T. max	T. di sistema T. of the system	Press.max Max. pressure
 acqua potabile drinking water	-20°C	+120°C	-20°C/+95°C	10 bar
 acqua calda sanitaria hot sanitary water	-20°C	+120°C	-20°C/+95°C	10 bar
 raffrescamento cooling	-20°C	+120°C	-20°C/+95°C	10 bar
 radiatori radiators	-20°C	+120°C	-20°C/+95°C	10 bar
 riscaldamento a pavimento floor heating	-20°C	+120°C	-20°C/+95°C	10 bar
 irrigazione irrigation	-20°C	+120°C	-20°C/+95°C	10 bar
 -20°C: solo con liquido antigelo glicole in % max del 30% -20°C: with the use of glycol in a maximum percentage of 30%				

COMPONENTI E MATERIALI COMPONENTS AND MATERIALS

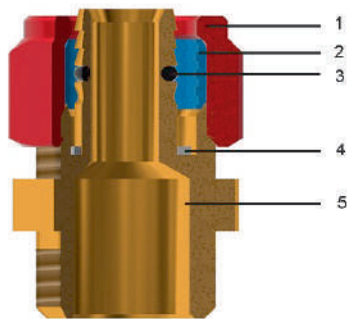

LEGENDA LEGEND	COMPONENTI COMPONENTS	MATERIALI MATERIALS
 1	Dado Nut	Ottone CW617N - UNI EN 12165 Brass CW617N - UNI EN 12165
 2	Ogiva tagliata Cut olive	Ottone CW617N - UNI EN 12164 Brass CW617N - UNI EN 12164
 3	O-Ring	Elastomero per acqua potabile Elastomer for drinking water
 4	Anello Isolante Insulated ring	TEFLON - FL8020
 5	Corpo Body	Ottone CW617N - UNI EN 12165 Brass CW617N - UNI EN 12165

SISTEMI PER TUBO
MULTISTRATO

FILETTATURA E SERRAGGIO DADI THREADS AND NUTS TIGHTENING

Ø	Attacco filetto	N° Giri (+1/4) N° Turns (+1/4)	Coppia di chiusura Tightening
Ø 14	G 1/2"	1/2	20 N*m
Ø 16	G 1/2"	1/2	22 N*m
Ø 18	G 3/4"	3/4	33 N*m
Ø 20	G 3/4"	3/4	35 N*m
Ø 26	G 1"	1/2	65 N*m
Ø 32	M 39 x 1.5	1/2	70 N*m

NORMATIVE

- ISO 21003-3
I raccordi sono conformi alla norma ISO 21003-3: "Sistemi di tubazioni multistrato per le installazioni di acqua calda e fredda all'interno degli edifici."
- UNI EN 228-1 2003
Tutte le filettature sono conformi alla norma UNI EN ISO 228-1:2003: " Filettatura di tubazioni per accoppiamento non a tenuta sul filetto".
- D.M. 174 (06/04/2004)
I materiali utilizzati sono conformi al Decreto Ministeriale n° 174 del 06/04/2004 [Regolamento concernente i materiali e gli oggetti che possono essere utilizzati negli impianti fissi di captazione, trattamento, adduzione e distribuzione delle acque destinate al consumo umano].
- Conforme a 4MS, UBA List (gruppo BC), DIN 50930/6 Dir. 2011/65/UE, 6C allegato III (RhOSII)
- Conforme a DVGW EN ISO 21003

REGULATIONS

- ISO 21003-3
"Multilayer piping systems for hot and cold water supply installations inside building"
- EN ISO 228-1:2003
Threads complies with UNI EN ISO 228-1:2003 law: "Piping thread for coupling not with tightness on the thread".
- D.M. 174 (06/04/2004)
Raw materials used are of high quality and comply with the Ministerial Decree N°174 dated 06/04/2004 concerning the materials and the items used in fixed installations for water collection, treatment and supply.
- Comply with 4MS, UBA List (BC group), DIN 50930/6 Dir. 2011/65/UE, 6C attachment III (RhOSII).
- Comply with DVGW EN ISO 21003

CERTIFICAZIONI CERTIFICATIONS

STATO COUNTRY	CERTIFICAZIONE CERTIFICATION	STATO COUNTRY	CERTIFICAZIONE CERTIFICATION	STATO COUNTRY	CERTIFICAZIONE CERTIFICATION
					
					
					
					

ISTRUZIONI DI MONTAGGIO ASSEMBLY INSTRUCTIONS

Utilizzando un apposito utensile taglia tubi [codice TT50.00] eseguire un taglio perpendicolare all'asse del tubo.

Cut the pipe perpendicularly to its axis using an appropriate pipe-cutting tool [code TT500.00].



Calibrare e sbavare il tubo con apposito calibro [codice CS50.00; MA00.90], facendo attenzione ad eliminare eventuali trucioli residui. Lo smusso interno deve essere compiuto su tutta la circonferenza.

Calibrate the pipe using special reamer [code CS50.00, MA00.90], removing possible residual chips. The pipe edge should be trimmed throughout the circumference.



Inserire dado e ogiva sul tubo.

Insert nut and olive on the pipe.



Inserire il tubo a battuta e avvitare il dado per quanto consentito. Con chiave esagonale avvitare il dado fino a raggiungere il n° di giri indicato in tabella (pag. precedente).

Insert the pipe in the body until it stops. With an hexagonal wrench, tighten the nut until reaching the number of threads shown in the table (see previous page).



5300.00

RACCORDO DIRITTO DOPPIO NICHELATO
NICKEL-PLATED DOUBLE STRAIGHT FITTING



CODICE	+	Ø	◇	☐
530000N142000A	2.0	14x14	10	100
530000N162000A	2.0	16x16	10	100
530000N182000A	2.0	18x18	10	80
530000N202000A	2.0	20x20	10	60
530000N252500A	2.0	25x25	5	40
530000N263000A	3.0	26x26	5	40
530000N323000A	3.0	32x32	-	25

5300.01

RACCORDO DIRITTO MASCHIO NICHELATO
NICKEL-PLATED MALE STRAIGHT FITTING



CODICE	+	Ø	◇	☐
530001N031420A	2.0	3/8"x14	10	160
530001N031620A	2.0	3/8"x16	10	160
530001N041420A	2.0	1/2"x14	10	160
530001N041620A	2.0	1/2"x16	10	160
530001N041820A	2.0	1/2"x18	10	100
530001N042020A	2.0	1/2"x20	10	100
530001N042630A	3.0	1/2"x26	10	50
530001N051620A	2.0	3/4"x16	10	120
530001N051820A	2.0	3/4"x18	10	100
530001N052020A	2.0	3/4"x20	10	80
530001N052525A	2.5	3/4"x25	5	50
530001N052630A	3.0	3/4"x26	5	50
530001N102525A	2.5	1"x25	5	50
530001N102630A	3.0	1"x26	5	40
530001N103230A	3.0	1"x32	-	40
530001N123230A	3.0	1 1/4"x32	-	25

5300.01

RACCORDO DIRITTO MASCHIO NICHELATO CON
FILETTO CONICO
NICKEL-PLATED MALE STRAIGHT FITTING, CONICAL
THREAD



CODICE	+	Ø	◇	☐
530001N03162CA	2.0	3/8"x16	10	150
530001N04162CA	2.0	1/2"x16	10	120
530001N04202CA	2.0	1/2"x20	10	80
530001N04263CA	3.0	1/2"x26	10	50
530001N05162CA	2.0	3/4"x16	10	100
530001N05202CA	2.0	3/4"x20	10	80
530001N05263CA	3.0	3/4"x26	5	40
530001N10263CA	3.0	1"x26	5	40

5300.02

RACCORDO DIRITTO FEMMINA NICHELATO
NICKEL-PLATED FEMALE STRAIGHT FITTING



CODICE	+	Ø	◇	☐
530002N041420A	2.0	1/2"x14	10	150
530002N041620A	2.0	1/2"x16	10	150
530002N041820A	2.0	1/2"x18	10	100
530002N042020A	2.0	1/2"x20	10	80
530002N042630A	3.0	1/2"x26	10	50
530002N051620A	2.0	3/4"x16	10	100
530002N051820A	2.0	3/4"x18	10	80
530002N052020A	2.0	3/4"x20	10	80
530002N052525A	2.5	3/4"x25	5	50
530002N052630A	3.0	3/4"x26	5	50
530002N102525A	2.5	1"x25	5	40
530002N102630A	3.0	1"x26	5	40
530002N103230A	3.0	1"x32	-	40
530002N123230A	3.0	1"1/4x32	-	25

5300.03

RACCORDO DIRITTO RIDOTTO NICHELATO
NICKEL-PLATED REDUCED STRAIGHT FITTING



CODICE	+	Ø	◇	☐
530003N665600A	2.0/2.0	20x16	10	60
530003N666200A	2.0/2.0	20x18	10	60
530003N775600A	3.0/2.0	26x16	10	40
530003N776600A	3.0/2.0	26x20	5	40
530003N806600A	3.0/2.0	32x20	5	30
530003N807700A	3.0/3.0	32x26	5	30

5300.10

RACCORDO A T NICHELATO
NICKEL-PLATED TEE



CODICE	+	Ø	◇	☐
530010N142000A	2.0	14x14x14	10	60
530010N162000A	2.0	16x16x16	10	60
530010N182000A	2.0	18x18x18	10	30
530010N202000A	2.0	20x20x20	10	30
530010N252500A	2.5	25x25x25	5	20
530010N263000A	3.0	26x26x26	5	20
530010N323000A	3.0	32x32x32	-	10

5300.11

RACCORDO A T MASCHIO NICHELATO
NICKEL-PLATED MALE TEE



CODICE	+	Ø	◇	☐
530011N041420A	2.0	14x1/2"x14	10	60
530011N041620A	2.0	16x1/2"x16	10	60
530011N041820A	2.0	18x1/2"x18	10	40
530011N042020A	2.0	20x1/2"x20	10	30
530011N051620A	2.0	16x3/4"x16	10	40
530011N051820A	2.0	18x3/4"x18	10	40
530011N052020A	2.0	20x3/4"x20	10	30
530011N052630A	3.0	26x3/4"x26	5	20
530011N053230A	3.0	32x3/4"x32	-	10
530011N102630A	3.0	26x1"x26	5	15
530011N103230A	3.0	32x1"x32	-	10

5300.11

RACCORDO A T MASCHIO NICHELATO CON FILETTO
CONICO
NICKEL-PLATED MALE TEE, CONICAL THREAD



CODICE	+	Ø	◇	☐
530011N04162CA	2.0	16x1/2"x16	10	50
530011N04202CA	2.0	20x1/2"x20	10	30
530011N05162CA	2.0	16x3/4"x16	10	50
530011N05202CA	2.0	20x3/4"x20	10	40
530011N05263CA	3.0	26x3/4"x26	5	20
530011N10263CA	3.0	26x1"x26	5	20

5300.12

RACCORDO A T FEMMINA NICHELATO
NICKEL-PLATED FEMALE TEE



CODICE	+	Ø	◇	☐
530012N041420A	2.0	14x1/2"x14	10	50
530012N041620A	2.0	16x1/2"x16	10	50
530012N041820A	2.0	18x1/2"x18	10	40
530012N042020A	2.0	20x1/2"x20	10	30
530012N051620A	2.0	16x3/4"x16	10	30
530012N051820A	2.0	18x3/4"x18	10	30
530012N052020A	2.0	20x3/4"x20	10	30
530012N052525A	2.5	25x3/4"x25	5	20
530012N052630A	3.0	26x3/4"x26	5	20
530012N053230A	3.0	32x3/4"x32	-	10
530012N102630A	3.0	26x1"x26	5	20
530012N103230A	3.0	32x1"x32	-	10

5300.13

RACCORDO A T RIDOTTO NICHELATO
NICKEL-PLATED REDUCED TEE



CODICE	+	Ø	◇	☐
530013N566656A	2.0/2.0/2.0	16x20x16	10	30
530013N666656A	2.0/2.0/2.0	20x16x16	10	30
530013N666666A	2.0/2.0/2.0	20x16x20	10	30
530013N666656A	2.0/2.0/2.0	20x20x16	10	30
530013N745674A	2.5/2.0/2.5	25x16x25	5	20
530013N746674A	2.5/2.0/2.5	25x20x25	5	20
530013N775677A	3.0/2.0/3.0	26x16x26	5	20
530013N776677A	3.0/2.0/3.0	26x20x26	5	20
530013N805680A	3.0/2.0/3.0	32x16x32	-	10
530013N806680A	3.0/2.0/3.0	32x20x32	-	10
530013N807780A	3.0/3.0/3.0	32x26x32	-	10

5300.19

RACCORDO A T RIDOTTO FEMMINA NICHELATO
NICKEL-PLATED REDUCED FEMALE TEE



CODICE	+	Ø	◇	☐
530019N660456A	2.0	20x1/2"x16	10	40
530019N660556A	2.0	20x1*3/4"x16	10	40

5300.20

ANGOLO DOPPIO NICHELATO
NICKEL-PLATED DOUBLE ELBOW



CODICE	+	Ø	◇	☐
530020N142000A	2.0	14x14	10	80
530020N162000A	2.0	16x16	10	80
530020N182000A	2.0	18x18	10	50
530020N202000A	2.0	20x20	10	50
530020N252500A	2.5	25x25	5	20
530020N263000A	3.0	26x26	5	20
530020N323000A	3.0	32x32	-	20

5300.21

ANGOLO MASCHIO NICHELATO
NICKEL-PLATED MALE ELBOW



CODICE	+	Ø	◇	☐
530021N041420A	2.0	1/2"x14	10	100
530021N041620A	2.0	1/2"x16	10	100
530021N041820A	2.0	1/2"x18	10	80
530021N042020A	2.0	1/2"x20	10	60
530021N051620A	2.0	3/4"x16	10	70
530021N051820A	2.0	3/4"x18	10	70
530021N052020A	2.0	3/4"x20	10	50
530021N052525A	2.5	3/4"x25	5	30
530021N052630A	3.0	3/4"x26	5	30
530021N102525A	2.5	1"x25	5	30
530021N102630A	3.0	1"x26	5	30
530021N103230A	3.0	1"x32	-	30

5300.21

ANGOLO MASCHIO NICHELATO CON FILETTO
CONICO
NICKEL-PLATED MALE ELBOW, CONICAL THREAD



CODICE	+	Ø	◇	☐
530021N04162CA	2.0	1/2"x16	10	100
530021N04202CA	2.0	1/2"x20	10	60
530021N05162CA	2.0	3/4"x16	10	80
530021N05202CA	2.0	3/4"x20	10	60
530021N05263CA	3.0	3/4"x26	5	40
530021N10263CA	3.0	1"x26	5	30

5300.22

ANGOLO FEMMINA NICHELATO
NICKEL-PLATED FEMALE ELBOW



CODICE	+	Ø	◇	☐
530022N041420A	2.0	1/2"x14	10	80
530022N041620A	2.0	1/2"x16	10	80
530022N041820A	2.0	1/2"x18	10	70
530022N042020A	2.0	1/2"x20	10	60
530022N051620A	2.0	3/4"x16	10	40
530022N051820A	2.0	3/4"x18	10	40
530022N052020A	2.0	3/4"x20	10	40
530022N052525A	2.5	3/4"x25	5	30
530022N052630A	3.0	3/4"x26	5	30
530022N102525A	2.5	1"x25	5	30
530022N102630A	3.0	1"x26	5	30
530022N103230A	3.0	1"x32	-	20

5300.23

ATTACCO A MURO NICHELATO CON FLANGIA 3 FORI
NICKEL-PLATED WALLPLATE ELBOW WITH 3 HOLES



CODICE	+	Ø	◇	☐
530023N041420A	2.0	1/2"x14	10	50
530023N041620A	2.0	1/2"x16	10	50
530023N041820A	2.0	1/2"x18	10	50
530023N042020A	2.0	1/2"x20	10	50
530023N052020A	2.0	3/4"x20	10	40

5300.23 Foro Singolo ATTACCO A MURO NICHELATO CON FLANGIA - FORO SINGOLO
NICKEL-PLATED WALLPLATE ELBOW - SINGLE HOLE



CODICE	+	i	Ø	◇	▢
530023N041606A	2.0	Foro singolo	1/2"x16	10	50

5300.36 CROCE NICHELATA
NICKEL-PLATED CROSS



CODICE	+	Ø	◇	▢
530036N142000A	2.0	14x14x14x14	10	60
530036N162000A	2.0	16x16x16x16	10	40
530036N182000A	2.0	18x18x18x18	10	20
530036N202000A	2.0	20x20x20x20	10	20

5300.85 ADATTATORE PER TUBO RAME
ADAPTER FOR COPPER PIPE



CODICE	+	Ø	◇	▢
530085N161500A	2.0	16x2.0x15	10	100

5300.85 ADATTATORE PER TUBO RAME
ADAPTER FOR COPPER PIPE



CODICE	+	Ø	◇	▢
530085N202200A	2.0	20x2.0x22	10	200

5300.40 TAPPO
CAP



CODICE	+	Ø	◇	▢
530040N162000A	2.0	16	10	150

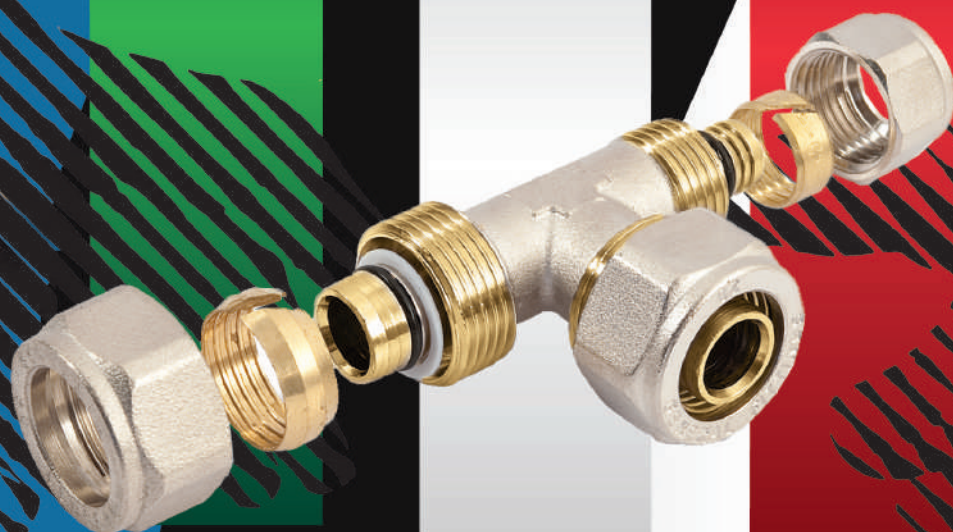

SISTEMI PER TUBO
MULTISTRATO

COMPREX

RACCORDI A COMPRESSIONE
CON OGIVA TAGLIATA
COMPRESSION FITTINGS
WITH CUT BRASS OLIVE



COMPREX

SERIE 5E00

LINE 5E00



Raccordi a compressione con inserto e ogiva tagliata

Compression fittings with removable pipe holder and cut olive

La serie 5E00 è composta da raccordi a compressione con inserto removibile e ogiva tagliata per tubo multistrato. I raccordi sono utilizzabili in impianti di adduzione di acqua calda e fredda per usi sanitari o di riscaldamento/raffrescamento, in ogni tipo di installazione idraulica (commerciale, domestica, industriale e agricola) e in linea di massima con fluidi non aggressivi. Il serraggio meccanico del raccordo e la compressione degli O-Ring del portatubo garantiscono la tenuta.

LINE 5E00 is made of compression fittings with removable pipe holder and cut olive. They are suitable for hot and cold water supply in sanitary and heating installations, and for any kind of sanitary installation such as domestic, commercial, industry and farming and with any type of non-corrosive fluid.

The seal is guaranteed by the mechanical tightening of the fitting and the compression of the O-Ring of the pipe holder.







VANTAGGI

- Ampia gamma
- Per acqua potabile e riscaldamento
- Garanzia di tenuta data dal serraggio meccanico del raccordo e dagli O-Ring del portatubo
- Materie prime impiegate di alta qualità [UBA LIST]
- Nichelatura non a contatto con l'acqua

ADVANTAGES

- Wide range
- For drinking water and heating
- Seal guaranteed by the mechanical tightening of the fitting and the compression of the O-Ring of the pipe holder.
- Raw materials complying with UBA LIST
- No contact between nickel and water

CAMPI DI APPLICAZIONI E PRESTAZIONI FIELDS OF APPLICATION

APPLICAZIONI APPLICATIONS	T. min.	T. max	T. di sistema T. of the system	Press.max Max. pressure
 acqua potabile drinking water	-20°C	+120°C	-20°C/+95°C	10 bar
 acqua calda sanitaria sanitary hot water	-20°C	+120°C	-20°C/+95°C	10 bar
 raffrescamento cooling	-20°C	+120°C	-20°C/+95°C	10 bar
 radiatori radiators	-20°C	+120°C	-20°C/+95°C	10 bar
 riscaldamento a pavimento floor heating	-20°C	+120°C	-20°C/+95°C	10 bar
 irrigazione irrigation	-20°C	+120°C	-20°C/+95°C	10 bar
 -20°C: solo con liquido antigelo glicole in % max del 30% -20°C: with the use of glycol in a maximum percentage of 30%				

COMPONENTI E MATERIALI COMPONENTS AND MATERIALS

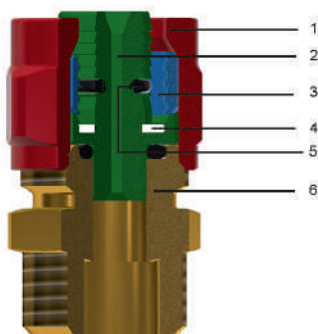

LEGENDA LEGEND	COMPONENTI COMPONENTS	MATERIALI MATERIALS
 1	Dado Nut	CW617N - UNI EN 12165 Brass CW617N - UNI EN 12165
 2	Insero Insert	CW617N - UNI EN 12164 Brass CW617N - UNI EN 12164
 3	Ogiva Olive	CW617N - UNI EN 12164 Brass CW617N - UNI EN 12164
 4	Anello Isolante Insulated ring	TEFLON - FL8020
 5	O-Ring	Elastomero per acqua potabile Elastomer for drinking water
 6	Corpo Body	CW617N - UNI EN 12165 Brass CW617N - UNI EN 12165

FILETTATURA E SERRAGGIO DADI THREADS AND NUTS TIGHTENING

Ø	Attacco filetto Thread coupling	N° Giri (+1/4) N° Turns (+1/4)
Ø 16	M21x1,5	3/4
Ø 18	M25x1,5	3/4
Ø 20	M25x1,5	3/4
Ø 26	M33x1,5	1
Ø 32	M38x1,5	3/4











NORMATIVE

- ISO 21003-3
I raccordi sono conformi alla norma ISO 21003-3: "Sistemi di tubazioni multistrato per le installazioni di acqua calda e fredda all'interno degli edifici".
- UNI EN 228-1 2003
Tutte le filettature sono conformi alla norma UNI EN ISO 228-1:2003: " Filettatura di tubazioni per accoppiamento non a tenuta sul filetto".
- D.M. 174 (06/04/2004)
I materiali utilizzati sono conformi al Decreto Ministeriale n° 174 del 06/04/2004 [Regolamento concernente i materiali e gli oggetti che possono essere utilizzati negli impianti fissi di captazione, trattamento, adduzione e distribuzione delle acque destinate al consumo umano].
- Conforme a 4MS, UBA List (gruppo BC), DIN 50930/6 Dir. 2011/65/UE, 6C allegato III (RhOSII)

REGULATIONS

- ISO 21003-3
"Multilayer piping systems for hot and cold water supply installations inside building".
- EN ISO 228-1:2003
Threads complies with UNI EN ISO 228-1:2003 law: "Piping thread for coupling not with tightness on the thread".
- D.M. 174 (06/04/2004)
Raw materials used are of high quality and comply with the Ministerial Decree N°174 dated 06/04/2004 concerning the materials and the items used in fixed installations for water collection, treatment and supply.
- Comply with 4MS, UBA List (BC group), DIN 50930/6 Dir. 2011/65/UE, 6C attachment III (RhOSII).

CERTIFICAZIONI CERTIFICATIONS

STATO COUNTRY	CERTIFICAZIONE CERTIFICATION	STATO COUNTRY	CERTIFICAZIONE CERTIFICATION
			
			
			

ISTRUZIONI DI MONTAGGIO ASSEMBLY INSTRUCTIONS

Utilizzando un apposito utensile taglia tubi [codice TT50.00] eseguire un taglio perpendicolare all'asse del tubo.

Cut the pipe perpendicularly to its axis using an appropriate pipe-cutting tool [code TT500.00].



Inserire dado e ogiva sul tubo.

Insert nut and olive on the pipe.



Infilare l'inserto nel tubo fino a battuta.

Insert the plug into the pipe until it stops.



Calzare il raccordo sull'inserto.

Assemble the fitting with the plug.



Avvitare il dado a mano, per quanto consentito, e con chiave esagonale avvitare il dado fino a raggiungere il numero massimo di giri (come da tabella pagina precedente)

Screw the nut by hand until allowed and with an hexagonal spanner screw it until you reach the number of threads (table on previous page).



5E00.00 RACCORDO DIRITTO DOPPIO NICHELATO
NICKEL-PLATED DOUBLE STRAIGHT FITTING



CODICE	+	Ø	◇	☐
5E0000N162000A	2.0	16x16	10	100
5E0000N182000A	2.0	18x18	10	80
5E0000N202000A	2.0	20x20	10	60
5E0000N263000A	3.0	26x26	5	30
5E0000N323000A	3.0	32x32	5	25

5E00.01 RACCORDO DIRITTO MASCHIO NICHELATO
NICKEL-PLATED MALE STRAIGHT FITTING



CODICE	+	Ø	◇	☐
5E0001N041620A	2.0	1/2"x16	10	120
5E0001N041820A	2.0	1/2"x18	10	120
5E0001N042020A	2.0	1/2"x20	10	100
5E0001N051620A	2.0	3/4"x16	10	100
5E0001N051820A	2.0	3/4"x18	10	100
5E0001N052020A	2.0	3/4"x20	10	80
5E0001N052630A	3.0	3/4"x26	5	40
5E0001N053230A	3.0	3/4"x32	5	30
5E0001N102630A	3.0	1"x26	5	50
5E0001N103230A	3.0	1"x32	5	30

5E00.02 RACCORDO DIRITTO FEMMINA NICHELATO
NICKEL-PLATED FEMALE STRAIGHT FITTING



CODICE	+	Ø	◇	☐
5E0002N041620A	2.0	1/2"x16	10	120
5E0002N041820A	2.0	1/2"x18	10	100
5E0002N042020A	2.0	1/2"x20	10	100
5E0002N051620A	2.0	3/4"x16	10	100
5E0002N051820A	2.0	3/4"x18	10	80
5E0002N052020A	2.0	3/4"x20	10	80
5E0002N052630A	3.0	3/4"x26	5	40
5E0002N053230A	3.0	3/4"x32	5	30
5E0002N102630A	3.0	1"x26	5	30
5E0002N103230A	3.0	1"x32	5	30

5E00.03 RACCORDO DIRITTO RIDOTTO NICHELATO
NICKEL-PLATED REDUCED STRAIGHT FITTINGS

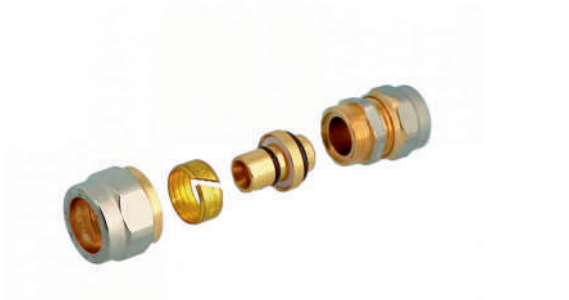

CODICE	+	Ø	◇	☐
5E0003N625600A	2.0	18x16	10	80
5E0003N665600A	2.0	20x16	10	70

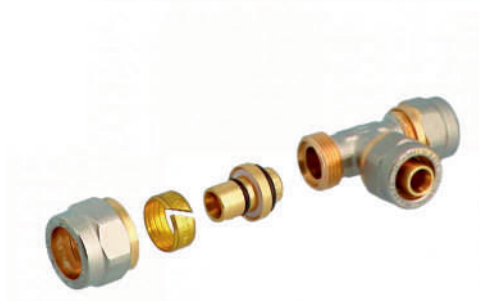
5E00.10RACCORDO A T NICHELATO
NICKEL-PLATED TEE

CODICE	+	Ø	◇	☐
5E0010N162000A	2.0	16x16x16	10	40
5E0010N182000A	2.0	18x18x18	5	30
5E0010N202000A	2.0	20x20x20	5	40
5E0010N263000A	3.0	26x26x26	-	15
5E0010N323000A	3.0	32x32x32	-	10

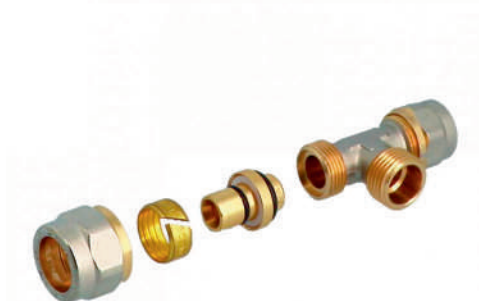
5E00.11RACCORDO A T MASCHIO NICHELATO
NICKEL-PLATED MALE TEE

CODICE	+	Ø	◇	☐
5E0011N041620A	2.0	1/2"x16	10	40
5E0011N041820A	2.0	1/2"x18	5	30
5E0011N042020A	2.0	1/2"x20	5	40
5E0011N051820A	2.0	3/4"x18	5	30
5E0011N052020A	2.0	3/4"x20	5	30
5E0011N052630A	3.0	3/4"x26	-	20
5E0011N102630A	3.0	1"x26	5	15
5E0011N103230A	3.0	1"x32	-	15

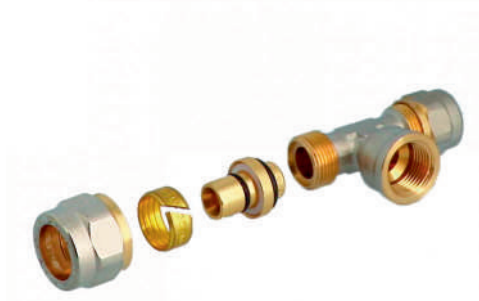
5E00.12RACCORDO A T FEMMINA NICHELATO
NICKEL-PLATED FEMALE TEE

CODICE	+	Ø	◇	☐
5E0012N041620A	2.0	1/2"x16	10	40
5E0012N041820A	2.0	1/2"x18	5	40
5E0012N042020A	2.0	1/2"x20	5	40
5E0012N051820A	2.0	3/4"x18	5	30
5E0012N052020A	2.0	3/4"x20	5	30
5E0012N052630A	3.0	3/4"x26	5	15
5E0012N053230A	3.0	3/4"x32	-	15
5E0012N103230A	3.0	1"x32	-	10

5E00.13RACCORDO A T RIDOTTO NICHELATO
NICKEL-PLATED REDUCED TEE

CODICE	+	Ø	◇	☐
5E0013N625656A	2.0/2.0/2.0	18x16x16	5	30
5E0013N625662A	2.0/2.0/2.0	18x16x18	5	30
5E0013N626256A	2.0/2.0/2.0	18x18x16	5	30
5E0013N665656A	2.0/2.0/2.0	20x16x16	5	30
5E0013N665666A	2.0/2.0/2.0	20x16x20	5	30
5E0013N666262A	2.0/2.0/2.0	20x20x16	5	30
5E0013N666266A	2.0/2.0/2.0	20x18x18	5	30
5E0013N666656A	2.0/2.0/2.0	20x18x20	5	30
5E0013N666662A	2.0/2.0/2.0	20x20x18	5	30

5E00.20

ANGOLO DOPPIO NICHELATO
NICKEL-PLATED DOUBLE ELBOW

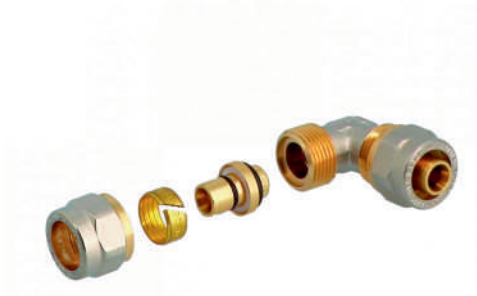

CODICE	+	Ø	◇	☐
5E0020N162000A	2.0	16x16	10	80
5E0020N182000A	2.0	18x18	10	60
5E0020N202000A	2.0	20x20	10	60
5E0020N263000A	3.0	26x26	-	25
5E0020N323000A	3.0	32x32	-	15

5E00.21

ANGOLO MASCHIO NICHELATO
NICKEL-PLATED MALE ELBOW

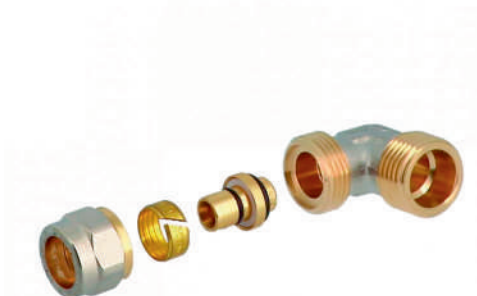

CODICE	+	Ø	◇	☐
5E0021N041620A	2.0	1/2"x16	10	100
5E0021N041820A	2.0	1/2"x18	10	80
5E0021N042020A	2.0	1/2"x20	10	80
5E0021N051820A	2.0	3/4"x18	10	70
5E0021N052020A	2.0	3/4"x20	10	70
5E0021N052630A	3.0	3/4"x26	5	30
5E0021N102630A	3.0	1"x26	5	30
5E0021N103230A	3.0	1"x32	-	20

5E00.22

ANGOLO FEMMINA NICHELATO
NICKEL-PLATED FEMALE ELBOW



CODICE	+	Ø	◇	☐
5E0022N041620A	2.0	1/2"x16	10	80
5E0022N041820A	2.0	1/2"x18	10	70
5E0022N042020A	2.0	1/2"x20	10	70
5E0022N051820A	2.0	3/4"x18	10	50
5E0022N052020A	2.0	3/4"x20	10	50
5E0022N052630A	3.0	3/4"x26	5	25
5E0022N053230A	3.0	3/4"x32	5	20
5E0022N102630A	3.0	1"x26	5	20
5E0022N103230A	3.0	1"x32	-	20

5E00.23

ATTACCO A MURO NICHELATO CON FLANGIA 3 FORI
NICKEL-PLATED WALLPLATE ELBOW WITH 3 HOLES

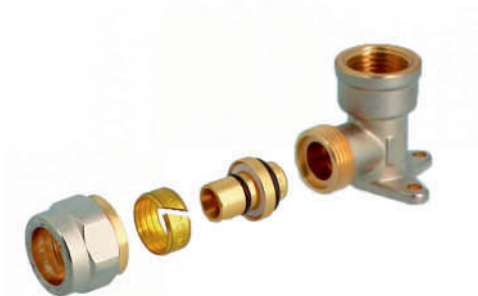

CODICE	+	Ø	◇	☐
5E0023N041620A	2.0	1/2"x16	10	50
5E0023N041820A	2.0	1/2"x18	10	40
5E0023N042020A	2.0	1/2"x20	10	40

5E00.80DADO, OGIVA E INSERTO
NUT, OLIVE AND INSERT

CODICE	+	Ø	◇	☐
5E0080N162000A	2.0	16	10	150
5E0080N182000A	2.0	18	10	150
5E0080N202000A	2.0	20	10	150
5E0080N263000A	3.0	26	5	60
5E0080N323000A	3.0	32	5	40



WOFLEX

SERIE 5500

LINE 5500

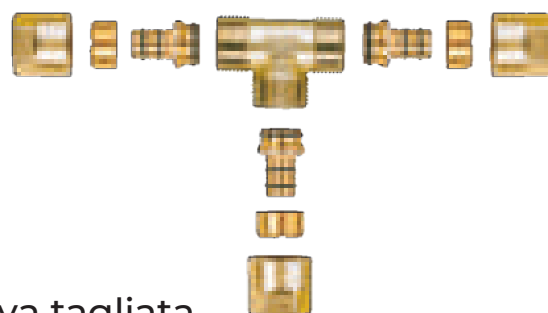

Raccordi a compressione con inserto e ogiva tagliata

Compression fittings with removable pipe holder and cut olive

I raccordi a compressione WOFLEX sono realizzati in lega di ottone UNI EN 12165 CW617-N e sono caratterizzati da un sistema a doppia tenuta, data dagli O-Rings e dal serraggio meccanico.

L'impiego dei raccordi WOFLEX avviene prevalentemente nel settore idrotermico, negli impianti d'adduzione (calda e fredda) e/o nelle distribuzioni per riscaldamento e raffreddamento. Sono inoltre utilizzabili con fluidi dotati di liquido antigelo, a base di glicoli e negli impianti pneumatici, con aria compressa.

I raccordi WOFLEX sono di facile utilizzo in quanto non richiedono l'impiego di particolari utensili e possono essere installati anche con il tubo multistrato WELCOFLEX.

WOFLEX compression fittings are made of UNI EN 12165 CW617-N brass alloy and are characterised by a double seal system provided by O-rings and mechanical tightening.

WOFLEX fittings are mainly used in the water-based heating industry, in supply systems (hot and cold) and/or in heating and cooling distribution systems. They can also be used with fluids containing glycol-based antifreeze and in pneumatic systems with compressed air.

WOFLEX fittings are easy to use as they do not require the use of special tools and can also be installed with WELCOFLEX multi-layer pipes.







VANTAGGI

- Garanzia di tenuta data dal serraggio meccanico del raccordo e dagli O-Rings del portatubo
- Per acqua potabile e riscaldamento
- Materie prime impiegate di alta qualità [UBA LIST]

ADVANTAGES

- *The mechanical tightening of the fitting and the O-rings of the pipe holder guarantee its seal*
- *For drinking water and heating*
- *Raw materials complying with UBA LIST*

CAMPI DI APPLICAZIONI E PRESTAZIONI FIELDS OF APPLICATION

APPLICAZIONI APPLICATIONS		T. min.	T. max	T.di sistema T.of the system	Press.max Max. pressure
	acqua potabile drinking water	-20°C	+120°C	-20°C/+95°C	10 bar
	acqua calda sanitaria sanitary hot water	-20°C	+120°C	-20°C/+95°C	10 bar
	raffrescamento cooling	-20°C	+120°C	-20°C/+95°C	10 bar
	radiatori radiators	-20°C	+120°C	-20°C/+95°C	10 bar
	riscaldamento a pavimento floor heating	-20°C	+120°C	-20°C/+95°C	10 bar
	irrigazione irrigation	-20°C	+120°C	-20°C/+95°C	10 bar
	-20°C: solo con liquido antigelo glicole in % max del 30% -20°C: with the use of glycol in a maximum percentage of 30%				

NORMATIVE

- ISO 21003-3

I raccordi sono conformi alla norma ISO 21003-3: "Sistemi di tubazioni multistrato per le installazioni di acqua calda e fredda all'interno degli edifici."

- UNI EN 228-1 2003

Tutte le filettature sono conformi alla norma UNI EN ISO 228-1:2003: "Filettatura di tubazioni per accoppiamento non a tenuta sul filetto"

- D.M. 174 (06/04/2004)

I materiali utilizzati sono conformi al Decreto Ministeriale n° 174 del 06/04/2004 [Regolamento concernente i materiali e gli oggetti che possono essere utilizzati negli impianti fissi di captazione, trattamento, adduzione e distribuzione delle acque destinate al consumo umano]

- Conforme a 4MS, UBA List (gruppo BC), DIN 50930/6 Dir. 2011/65/UE, 6C allegato III (RhOSII)

REGULATIONS

- ISO 21003-3

"Multilayer piping systems for hot and cold water supply installations inside building"

- EN ISO 228-1:2003

Threads complies with UNI EN ISO 228-1:2003 law: "Piping thread for coupling not with tightness on the thread".

- D.M. 174 (06/04/2004)

Raw materials used are of high quality and comply with the Ministerial Decree N°174 dated 06/04/2004 concerning the materials and the items used in fixed installations for water collection, treatment and supply.

- Comply with 4MS, UBA List (BC group), DIN 50930/6 Dir. 2011/65/UE, 6C attachment III (RhOSII).

ISTRUZIONI DI MONTAGGIO ASSEMBLY INSTRUCTIONS

Utilizzando un apposito utensile taglia tubi eseguire un taglio perpendicolare all'asse del tubo. Non impiegare tagliatubi a "ghigliottina" che solitamente si utilizzano solo per tubi in plastica.

Using a special pipe cutting tool, make a cut perpendicular to the axis of the pipe. Do not use 'guillotine' pipe cutters that are usually only used for plastic pipes



Calibrare e sbavare il tubo con apposito calibro, facendo attenzione ad eliminare eventuali trucioli residui. Lo smusso interno deve essere compiuto su tutta la circonferenza.

Calibrate and deburr the pipe with a special gauge, taking care to eliminate any residual chips. The internal chamfer must be made on the entire circumference.



Installare nel tubo dado e anello; inserire quindi il portagomma sino in fondo, dopo aver controllato che siano presenti tutti gli O-Rings. In questa fase l'uso di un lubrificante spray facilita l'introduzione, ma soprattutto evita il danneggiamento degli O-Rings. L'inserimento del tubo nel portagomma è un'operazione da effettuarsi con grande attenzione in quanto l'involontaria fuoriuscita dell'O-Ring dal suo alloggiamento può essere la causa che impedisce la tenuta.



Install the nut and ring in the pipe, then push the pipe connection inside to the end, after checking that all the O-rings are present. At this stage, the use of a spray lubricant can facilitate the assembly of the parts, but above all it prevents damage to the O-rings. The insertion of the pipe in the pipe connection is an operation to be carried out with particular care, as the seal may not be formed if the O-Ring slips out of its housing.

Fare attenzione che il portagomma sia inserito sino in fondo.

Make sure that the pipe connection is fully inserted.

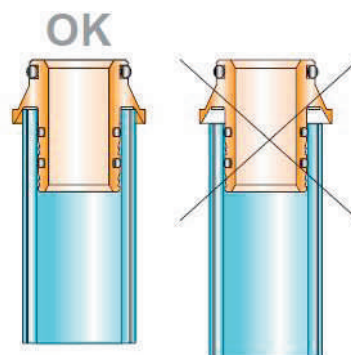

Avvitare manualmente il dado sin quanto è possibile e verificare che l'avvitamento avvenga senza forzare, poichè il tubo deve essere in asse con il raccordo. Procedere quindi al serraggio con chiavi fisse.

Manually tighten the nut as far as possible but without forcing it, as the pipe must be in line with the fitting. Then tighten with fixed spanners.



5500.00

RACCORDO DIRITTO DOPPIO
DOUBLE STRAIGHT FITTING



CODICE	+	Ø	◇	☐
550000H162000T	2.0	16x16	10	80
550000H202000T	2.0	20x20	10	40
550000H162200T	2.25	16x16	10	80
550000H202500T	2.5	20x20	10	40
550000H263000T	3.0	26x26	5	25

5500.01

RACCORDO DIRITTO MASCHIO
MALE STRAIGHT FITTING



CODICE	+	Ø	◇	☐
550001H041620T	2.0	16x1/2"	10	100
550001H051620T	2.0	16x3/4"	10	80
550001H042020T	2.0	20x1/2"	10	70
550001H052020T	2.0	20x3/4"	10	60
550001H041622T	2.25	16x1/2"	10	100
550001H051622T	2.25	16x3/4"	10	80
550001H042025T	2.5	20x1/2"	10	70
550001H052025T	2.5	20x3/4"	10	60
550001H052630T	3.0	26x3/4"	10	40
550001H102630T	3.0	26x1"	10	30
550001H103230H	3.0	32x1"	5	25

5500.02

RACCORDO DIRITTO FEMMINA
FEMALE STRAIGHT FITTING



CODICE	+	Ø	◇	☐
550002H041620T	2.0	16x1/2"	10	90
550002H051620T	2.0	16x3/4"	10	50
550002H042020T	2.0	20x1/2"	10	50
550002H052020T	2.0	20x3/4"	10	50
550002H041622T	2.25	16x1/2"	10	90
550002H051622T	2.25	16x3/4"	10	50
550002H042025T	2.5	20x1/2"	10	50
550002H052025T	2.5	20x3/4"	10	50
550002H052630T	3.0	26x3/4"	5	30
550002H102630T	3.0	26x1"	5	30

5500.10

RACCORDO A T
TEE



CODICE	+	Ø	◇	☐
550010H162000T	2.0	16x16x16	10	40
550010H202000T	2.0	20x20x20	5	20
550010H162200T	2.25	16x16x16	10	40
550010H202500T	2.5	20x20x20	5	20
550010H263000T	3.0	26x26x26	5	10

5500.12RACCORDO A T FEMMINA
FEMALE TEE

CODICE	+	Ø	◇	☐
550012H041620T	2.0	1/2"x16	10	40
550012H042020T	2.0	1/2"x20	10	30
550012H052020T	2.0	3/4"x20	5	20
550012H041622T	2.25	1/2"x16	10	40
550012H042025T	2.5	1/2"x20	10	30
550012H052025T	2.5	3/4"x20	5	20
550012H052630T	3.0	3/4"x26	5	15
550012H102630T	3.0	1"x26	5	10

5500.20ANGOLO DOPPIO
DOUBLE ELBOW

CODICE	+	Ø	◇	☐
550020H162000T	2.0	16x16	10	50
550020H202000T	2.0	20x20	10	40
550020H162200T	2.25	16x16	10	50
550020H202500T	2.5	20x20	10	40
550020H263000T	3.0	26x26	5	20

5500.21ANGOLO MASCHIO
MALE ELBOW

CODICE	+	Ø	◇	☐
550021H041620T	2.0	1/2"x16	10	50
550021H042020T	2.0	1/2"x20	10	50
550021H052020T	2.0	3/4"x20	10	50
550021H041622T	2.25	1/2"x16	10	50
550021H042025T	2.5	1/2"x20	10	50
550021H052025T	2.5	3/4"x20	10	50
550021H052630T	3.0	3/4"x26	10	30
550021H102630T	3.0	1"x26	5	25

5500.22ANGOLO FEMMINA
FEMALE ELBOW

CODICE	+	Ø	◇	☐
550022H041620T	2.0	1/2"x16	10	60
550022H042020T	2.0	1/2"x20	10	40
550022H052020T	2.0	3/4"x20	10	40
550022H041622T	2.25	1/2"x16	10	60
550022H042025T	2.5	1/2"x20	10	40
550022H052025T	2.5	3/4"x20	10	40
550022H052630T	3.0	3/4"x26	10	20
550022H102630T	3.0	1"x26	5	20

5500.23

ATTACCO A MURO CON FLANGIA 3 FORI
WALLPLATE ELBOW WITH 3 HOLES



CODICE	+	Ø	◇	📦
550023H041620T	2.0	1/2"x16	10	30
550023H042020T	2.0	1/2"x20	10	30
550023H041622T	2.25	1/2"x16	10	30
550023H042025T	2.5	1/2"x20	10	30

5500.70

DADO
NUT



CODICE	Ø	◇	📦
550070H041600T	16	25	200
550070H052000T	20	-	300
550070H102600T	26	-	-

5500.81

OGIVA
OLIVE



CODICE	Ø	◇	📦
550081R041600H	16	25	1000
550081R052000H	20	25	400
550081R102600H	26	-	-

PR55.80

INSERTO
INSERT

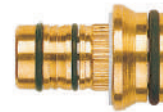

CODICE	+	Ø	◇	📦
PR5580H041620H	2.0	16	25	500
PR5580H052020H	2.0	20	25	300
PR5580H041622H	2.25	16	25	500
PR5580H052025H	2.5	20	25	300
PR5580H102630H	3.0	26	-	-



Raccordi eurocono

Eurocone fittings

Disponibili diverse figure di raccordi nichelati con attacco eurocono.

Various nickel-plated fittings with Euroconus connection available.

5700.00.N RACCORDO DIRITTO NICHELATO ATTACCO EUROCONO
EUROCONO
NICKEL-PLATED STRAIGHT FITTING FOR EUROCONE



CODICE	Ø	◇	📦
570000N050500H	3/4" EKx3/4" EK	10	120

Utilizzabile con 5700.80, 6300.80, 3300.80, 2700.H4, 5700.H4, 7E00.H4, 6300.85

Can be used with 5700.80, 6300.80, 3300.80, 2700.H4, 5700.H4, 7E00.H4, 6300.85

5700.03.N RACCORDO DIRITTO RIDOTTO NICHELATO ATTACCO EUROCONO
EUROCONO
NICKEL-PLATED REDUCED STRAIGHT FITTING FOR EUROCONE



CODICE	Ø	◇	📦
570003N050400H	1/2"x3/4" EK	10	150

Utilizzabile con 5700.80, 6300.80, 3300.80, 2700.H4, 5700.H4, 7E00.H4, 6300.85

Can be used with 5700.80, 6300.80, 3300.80, 2700.H4, 5700.H4, 7E00.H4, 6300.85

5700.10.N RACCORDO A T NICHELATO ATTACCO EUROCONO
NICKEL-PLATED T-FITTING EUROCONE CONNECTION



CODICE	Ø	◇	📦
570010N050505A	3/4"EKx3/4"EKx3/4"EK	10	50

Utilizzabile con 5700.80, 6300.80, 3300.80, 2700.H4, 5700.H4, 7E00.H4, 6300.85

Can be used with 5700.80, 6300.80, 3300.80, 2700.H4, 5700.H4, 7E00.H4, 6300.85

5700.20.N RACCORDO AD ANGOLO NICHELATO ATTACCO EUROCONO
EUROCONO
NICKEL-PLATED ELBOW FITTING



CODICE	Ø	◇	📦
570020N050500A	3/4"EKx3/4"EK	10	80

Utilizzabile con 5700.80, 6300.80, 3300.80, 2700.H4, 5700.H4, 7E00.H4, 6300.85

Can be used with 5700.80, 6300.80, 3300.80, 2700.H4, 5700.H4, 7E00.H4, 6300.85



Tubi multistrato per acqua

Multilayer pipes for water installations



Il tubo Multistrato è contraddistinto da una struttura di 5 strati in cui uno strato di alluminio saldato testa a testa è racchiuso tra due strati di polietilene reticolato (PEX) e fissato a questi ultimi mediante due veli di adesivo. Grazie a questa caratteristica il tubo della serie TB00.20 rappresenta un perfetto connubio tra le proprietà della plastica (polietilene reticolato alta resistenza meccanica) e del metallo duttile (Alluminio alta flessibilità), in cui i pregi del PEX si sommano a quelli dell'alluminio dando vita ad un prodotto dalle straordinarie e molteplici qualità. Il PEX conferisce resistenza chimica, resistenza alla corrosione, leggerezza, igienicità e garantisce una superficie di contatto con il fluido trasportato molto liscia e levigata tale da ridurre le perdite di carico ed evitare incrostazioni. La presenza di alluminio consente di poter modellare il tubo con estrema semplicità in modo da velocizzare notevolmente l'installazione ed impedire il passaggio d'ossigeno all'interno della condotta. Il tubo è idoneo per impianti sanitari, di riscaldamento, di raffrescamento e aria compressa.

The multilayer pipe is characterized by a 5-layer structure in which a butt-welded aluminum layer is enclosed between two layers of cross-linked polyethylene (PEX) and fixed to the latter by two layers of adhesive. Thanks to this feature, TB00.20 pipe represents a perfect combination of the properties of plastic (cross-linked polyethylene with high mechanical resistance) and ductile metal (highly flexible aluminum), in which the qualities of PEX are added to those of aluminum, giving life to a product with extraordinary and multiple qualities. PEX confers chemical resistance, corrosion resistance, lightness, hygiene and guarantees a very smooth and polished surface in contact with the transported fluid such as to reduce pressure drops and avoid encrustations. The presence of aluminum allows the pipe to be modeled very easily in order to significantly speed up installation and prevent the passage of oxygen inside the pipeline. The pipe is suitable for sanitary, heating, cooling and compressed air systems.

VANTAGGI

- Eccellente isolamento acustico: l'elasticità del polietilene reticolato consente di ottenere un ottimo assorbimento delle vibrazioni
- Resistenza alla corrosione e all'abrasione
- Leggerezza: le tubazioni sono molto più leggere rispetto ai tubi metallici
- Igiene: i materiali utilizzati sono atossici e certificati per il trasporto di acqua potabile
- Igienicità, assenza di incrostazioni e funghi (l'estrema levigatezza della superficie interna riduce la possibilità di ostruzioni causate da crescita di incrostazioni e funghi)
- Perdite di carico ridotte: la superficie interna liscia e levigata riduce le perdite di carico ed evita la formazione di incrostazioni
- Flessibilità: la presenza dell'alluminio ad alto grado di snervamento consente di modellare il tubo con estrema facilità
- Ridotta dilatazione termica: la dilatazione termica è contenuta a 0,026mm/m°C
- Resistenza chimica ed elettrochimica (essendo il PEX un cattivo conduttore elettrico non è soggetto a fenomeni distruttivi delle correnti vaganti)
- Barriera alla luce e all'ossigeno: lo strato di alluminio saldato testa/testa costituisce una barriera all'ossigeno che favorisce la formazione di alghe, funghi e corrosione
- Ideale per zone sismiche grazie alla flessibilità e capacità di attenuazione delle vibrazioni

ADVANTAGES

- *Excellent sound insulation: the elasticity of the cross-linked polyethylene allows for excellent absorption of vibrations*
- *Corrosion resistance*
- *Lightness: pipes are much lighter than metal pipes*
- *Hygiene: the materials used are non-toxic and certified for the transport of drinking water*
- *Hygiene, absence of encrustations and fungi (the extreme smoothness of the internal surface reduces the possibility of obstructions caused by the growth of encrustations and fungi)*
- *Reduced pressure drops: the smooth and polished internal surface reduces pressure drops and avoids the formation of encrustations*
- *Flexibility: the presence of aluminum with a high degree of yield allows the tube to be modeled very easily*
- *Reduced thermal expansion: thermal expansion is limited to 0.026mm / m °C*
- *Chemical and electrochemical resistance (PEX being a bad electrical conductor it is not subject to destructive phenomena of stray currents)*
- *Barrier to light and oxygen: the butt-welded aluminum layer forms an oxygen barrier that promotes the formation of algae, fungi and corrosion*
- *Ideal for seismic areas thanks to its flexibility and ability to attenuate vibrations*

CAMPI DI APPLICAZIONI E PRESTAZIONI FIELDS OF APPLICATION

APPLICAZIONI APPLICATIONS		T. di sistema T. of the system	Press. Max
 acqua potabile drinking water		-20°C/+95°C	10 bar
 acqua calda sanitari hot sanitary water		-20°C/+95°C	10 bar
 raffrescamento cooling		-20°C/+95°C	10 bar
 condizionamento conditioning		-20°C/+95°C	10 bar
 radiatori radiators		-20°C/+95°C	10 bar
 riscaldamento a pavimento floor heating		-20°C/+95°C	10 bar
 irrigazione irrigation		-20°C/+95°C	10 bar

COMPOSIZIONE DEL TUBO NUDO COMPOSITION OF BARE PIPE



COMPOSIZIONE STRATI LAYER COMPOSITION

Un tubo interno in polietilene reticolato (PEX)
A cross-linked polyethylene (PEX) inner pipe

Uno strato di collante di elevata qualità per poter garantire un collegamento omogeneo tra il tubo in alluminio e il tubo interno in PEX
A layer of high quality glue to ensure a homogeneous connection between the aluminum pipe and the internal PE-X pipe

Un tubo in alluminio, saldato in senso longitudinale e controllato elettronicamente
An aluminum tube, longitudinally welded and electronically controlled

Uno strato di collante di elevata qualità per poter garantire un collegamento omogeneo tra il tubo in alluminio e il tubo esterno in PEX
A layer of high quality glue to ensure a homogeneous connection between the aluminum pipe and the external PEX pipe

Un tubo esterno in polietilene reticolato (PEX)
A cross-linked polyethylene (PEX) outer pipe

COMPOSIZIONE DEL TUBO RIVESTITO COATED PIPE COMPOSITION



COMPOSIZIONE STRATI LAYER COMPOSITION

Un tubo interno in polietilene reticolato (PEX)
A cross-linked polyethylene (PEX) inner pipe

Uno strato di collante di elevata qualità per poter garantire un collegamento omogeneo tra il tubo in alluminio e il tubo interno in PEX
A layer of high quality glue to ensure a homogeneous connection between the aluminum pipe and the internal PE-X pipe

Un tubo in alluminio, saldato in senso longitudinale e controllato elettronicamente
An aluminum tube, longitudinally welded and electronically controlled

Uno strato di collante di elevata qualità per poter garantire un collegamento omogeneo tra il tubo in alluminio e il tubo esterno in PEX
A layer of high quality glue to ensure a homogeneous connection between the aluminum pipe and the external PEX pipe

Un tubo esterno in polietilene reticolato (PEX)
A cross-linked polyethylene (PEX) outer pipe

Rivestimento: strato di materiale coibentante, realizzato in polietilene espanso a cellule chiuse, che incrementa l'efficienza energetica dell'installazione, e migliora ulteriormente la già ridotta rumorosità. La struttura del rivestimento è costituita da due strati. Il rivestimento ha proprietà isolante ZQ038 e la pellicola esterna è in PVC autoestingente.
Coating: layer of insulating material, made of closed cell expanded polyethylene, which increases the energy efficiency of the installation, and further improves the already reduced noise level. The coating structure consists of two layers. The coating has ZQ038 insulating properties and the outer film is in self-extinguishing PVC.

CERTIFICAZIONI CERTIFICATIONS

STATO COUNTRY	CERTIFICAZIONE CERTIFICATION	STATO COUNTRY	CERTIFICAZIONE CERTIFICATION	STATO COUNTRY	CERTIFICAZIONE CERTIFICATION
					KTW-BWGL

CERTIFICAZIONI

KIWA-DVGW in accordo alla UNI EN ISO 21003.

Il nuovo regolamento prevede che la marcatura riporti solo le classi di applicazioni e le temperature di progetto del tubo. Ogni altra indicazione di temperatura e pressione genera confusione

Il tubo General Fittings, certificato da prestigiosi organismi preposti, trova la sua applicazione in forniture di acqua calda continua a 70°C.

Il tubo General Fittings è quindi garantito per un funzionamento continuo di fornitura di acqua calda a 70°C per 49 anni e, per un anno a 80°C, per 100h a 95°C, quest'ultima considerata come temperatura di mal funzionamento.

NORMATIVE

- ISO 21003-2

E' lo standard europeo per i tubi multistrato per acqua calda e fredda nelle installazioni all'interno delle abitazioni. Questa normativa specifica le caratteristiche generali dei tubi e sistemi multistrato per convogliamento di acqua calda e fredda all'interno delle abitazioni nei sistemi di riscaldamento e acqua potabile

POLIETILENE RETICOLATO (PEX)

Il polietilene è un materiale polimerico termoplastico composto da numerose molecole lunghe che, anche a temperature moderatamente elevate (ancora sotto il punto di fusione), comincia ad avere un significativo grado di fluidità.

Con il processo di reticolazione le molecole di polietilene si legano insieme per formare una struttura tridimensionale più complessa: la reazione chimica di reticolazione trasforma infatti il prodotto da termoplastico a termoisolante.

Il materiale subisce una modificazione strutturale che ne migliora le caratteristiche quali l'abrasione, la resistenza chimica, la resistenza meccanica nel tempo, la resistenza all'invecchiamento e alle alte temperature. Le prestazioni meccaniche del materiale vengono incrementate significativamente.

Il polietilene reticolato può essere prodotto mediante tecnologie diverse riconosciute dalle norme internazionali e identificate con i metodi A (perossidi), B (silani), C (radiazioni). Il metodo utilizzato viene indicato dopo la sigla del materiale ottenendo rispettivamente PE-Xa, PE-

CERTIFICATIONS

KIWA-DVGW in accordance with UNI EN ISO 21003.

The new regulation requires the marking to report only the classes of applications and temperatures of the pipe project. Any other indication of temperature and pressure is confusing

General Fittings pipe, certified by prestigious bodies, finds its application in continuous hot water supplies at 70 °C.

General Fittings pipe is therefore guaranteed for continuous operation of hot water supply at 70 °C for 49 years and, for one year at 80 °C, for 100h at 95 °C, the latter considered as a malfunction temperature.

REGULATIONS

- ISO 21003-2

It is the European standard for multilayer pipes for hot and cold water in installations inside homes. This legislation specifies the general characteristics of pipes and multilayer systems for conveying hot and cold water inside homes in heating and drinking water systems

CROSS-LINKED POLYETHYLENE (PEX)

Polyethylene is a thermoplastic polymeric material composed of numerous long molecules that, even at moderately high temperatures (still below the melting point), begins to have a significant degree of fluidity. With the cross-linking process, the polyethylene molecules are bonded together to form a more complex three-dimensional structure: the chemical cross-linking reaction transforms the product from thermoplastic to thermosetting.

The material undergoes a structural modification that improves its characteristics such as abrasion, chemical resistance, mechanical resistance over time, resistance to ageing and high temperatures. The mechanical performance of the material is significantly increased. Cross-linked polyethylene can be produced by different technologies recognised by international standards and identified by methods A (peroxides), B (silanes), and C (radiation). The method used is indicated after the abbreviation of the material: PE-Xa, PE-Xb, PE-Xc.

All the above methods are valid: it is not the cross-linking process that defines the quality of the product, but its

Xb, PE-Xc.

Tutti i metodi sopracitati valgono: non è il processo di reticolazione che definisce la bontà del prodotto, bensì la sua capacità di superare i test fisici e meccanici definiti dalle norme.

PERMEABILITA' ALL'OSSIGENO

Il tubo di General Fittings risulta impermeabile a qualsiasi fenomeno di diffusione, in quanto la struttura intermedia in alluminio garantisce un passaggio nullo dei gas all'interno del tubo stesso.

Tale caratteristica lo rende la soluzione perfetta in ogni impianto di riscaldamento che preveda scambiatori in alluminio o fasci tubieri metallici sensibili alla diffusione dell'ossigeno.

Le tubazioni multistrato di General Fittings possono inoltre essere utilizzate in impianti di riscaldamento a pavimento in conformità a quanto previsto dalla normativa UNI EN1264 che prescrive barriera anti-diffusione dell'ossigeno sulle tubazioni per impianti radianti limitandone a 0,32 mg/m² al giorno allo scopo di evitare la riduzione della vita utile della tubazione stessa.

PRIMER ADESIVANTE

Il nastro di alluminio è fissato agli strati interno ed esterno in PEX mediante due strati di colla.

Quest'ultima è stata specificatamente sviluppata per massimizzare l'adesione fra PEX ed alluminio e per fare in modo che la forza di incollaggio non decada con il tempo e con temperature elevate.

Grazie all'adesivo i due strati di PEX e lo strato di alluminio vanno a costituire un tutt'uno con proprietà superiori rispetto al singolo componente.

RIVESTIMENTO (nel caso di Tubo rivestito)

Lo strato di materiale coibentante, realizzato in polietilene espanso a cellule chiuse, oltre ad incrementare l'efficienza energetica dell'installazione, va a migliorare ulteriormente la già ridotta rumorosità degli impianti realizzati con materiali sintetici.

La sezione isolante è costituita da uno strato di polietilene espanso a cellule chiuse (privo di CFC) protetto da una caratteristica pellicola di rivestimento esterna di colore rosso, blu e grigio e di colore bianco

N.B. E' fortemente consigliato consultare sempre un termotecnico per definire gli spessori di coibentazione.

ability to pass the physical and mechanical tests defined by the standards.

PERMEABILITY TO OXYGEN

General Fittings pipe is impermeable to any diffusion phenomenon, as the intermediate aluminum structure guarantees a zero passage of gases inside the tube itself. This feature makes it the perfect solution in any heating system that includes aluminum exchangers or metal tube bundles sensitive to oxygen diffusion.

General Fittings multilayer pipes can also be used in underfloor heating systems in compliance with the provisions of the UNI EN1264 standard which prescribes an oxygen diffusion barrier on the pipes for radiant floor heat systems, limiting it to 0.32 mg / m² per day in order to avoid the reduction of the useful life of the pipe itself.

ADHESIVE PRIMER

The aluminum tape is attached to the inner and outer PEX layers by two layers of glue.

The latter was specifically developed to maximize the adhesion between PEX and aluminum and to ensure that the bond strength does not decline with time and with high temperatures.

Thanks to the adhesive, the two layers of PEX and the aluminum layer form a whole with superior properties compared to the single component.

COVERING (in case of coated pipe)

The layer of insulating material, made of closed cell polyethylene foam, in addition to increasing the energy efficiency of the installation, further improves the already reduced noise level of systems made of synthetic materials.

La sezione isolante è costituita da uno strato di polietilene espanso a cellule chiuse (privo di CFC) protetto da una caratteristica pellicola di rivestimento esterna di colore rosso, blu e grigio e di colore bianco

N.B. E' fortemente consigliato consultare sempre un termotecnico per definire gli spessori di coibentazione.

CLASSI D'APPLICAZIONE APPLICATION CLASSES

Classe Class	Temperatura di progetto Design Temperature	TIMEb a TD TIMEb at TD	T max	Tempo a T max Time at T max	T mal	Tempo a T mal Time at T mal	Campi di applicazione Typical Field of application
1a	60	49	80	1	95	100	Acqua calda sanitaria (60 °C) Hot water supply (60 °C)
2a	70	49	80	1	95	100	Acqua calda sanitaria (70 °C) Hot water supply (70 °C)
4b	20 plus cumulative	2.5	70	2.5	100		Riscaldamento a pavimento e radiatori a bassa temperatura Underfloor heating and low temperatures radiators
4b	40 plus cumulative	20	70	2.5	100		Riscaldamento a pavimento e radiatori a bassa temperatura Underfloor heating and low temperatures radiators
4b	60	25	70	2.5	100		Riscaldamento a pavimento e radiatori a bassa temperatura Underfloor heating and low temperatures radiators
5b	20 plus cumulative	14	90	1	100		Riscaldamento a pavimento e radiatori a bassa temperatura High temperatures radiators
5b	60 plus cumulative	25	90	1	100		Riscaldamento a pavimento e radiatori a bassa temperatura High temperatures radiators
5b	80	10	90	1	100		Riscaldamento a pavimento e radiatori a bassa temperatura High temperatures radiators

TB00.20 BARS TUBO MULTISTRATO PE-Xb/Al/PE-Xb IN BARRA
PE-Xb/Al/PE-Xb PIPE IN BAR



CODICE	Ø	—	■
TB0020H162004H	16x2.0	4 m	100 m
TB0020H202004H	20x2.0	4 m	64 m
TB0020H263004H	26x3.0	4 m	40 m
TB0020H323004H	32x3.0	4 m	28 m

TB00.20 COILS TUBO MULTISTRATO PE-Xb/Al/PE-Xb IN ROTOLI
PE-Xb/Al/PE-Xb PIPE IN COILS



CODICE	Ø	🌀	■
TB0020H162000H	16x2.0	100 m	5200 m
TB0020H162020H	16x2.0	200 m	2000 m
TB0020H162050H	16x2.0	500m	5000m
TB0020H202000H	20x2.0	100 m	1300 m
TB0020H252500H	25x2.5	50 m	600 m
TB0020H263000H	26x3.0	50 m	600 m
TB0020H323002H	32x3.0	50 m	500 m

TB00.20 GREY TUBO MULTISTRATO PE-Xb/Al/PE-Xb RIVESTITO GRIGIO
PE-Xb/Al/PE-Xb PIPE WITH GREY INSULATION



CODICE	i	Ø	🌀	■
TB0020G162000H*	6 mm	16x2.0	50 m	700 m
TB0020G202010H*	10 mm	20x2.0	50 m	600 m
TB0020G202000H	6 mm	20x2.0	50 m	600 m
TB0020G263010H*	10 mm	26x3.0	50 m	700 m
TB0020G263000H	6 mm	26x3.0	50 m	500 m
TB0020G323000H*	10 mm	32x3.0	25 m	250 m

*Isolamento conforme a legge 10/91 Cap.C

*Insulation according to law 10/91 Cap.C

TB00.20 BLUE TUBO MULTISTRATO PE-Xb/Al/PE-Xb RIVESTITO BLU
PE-Xb/Al/PE-Xb PIPE WITH BLUE INSULATION



CODICE	i	Ø	🌀	■
TB0020B162000H*	6 mm	16x2.0	50 m	700 m
TB0020B202000H	6 mm	20x2.0	50 m	600 m
TB0020B252500H	6 mm	25x2.5	50 m	600 m
TB0020B263000H	6 mm	26x3.0	50 m	500 m
TB0020B323000H*	10 mm	32x3.0	25 m	250 m

*Isolamento conforme a legge 10/91 Cap.C

*Insulation according to law 10/91 Cap.C

TB00.20 RED TUBO MULTISTRATO PE-Xb/Al/PE-Xb RIVESTITO ROSSO
PE-Xb/Al/PE-Xb PIPE WITH RED INSULATION



CODICE	i	Ø		
TB0020R162000H*	6 mm	16x2.0	50 m	700 m
TB0020R202000H	6 mm	20x2.0	50 m	600 m
TB0020R252500H	6 mm	25x2.5	50 m	600 m
TB0020R263000H	6 mm	26x3.0	50 m	500 m
TB0020R323000H*	10 mm	32x3.0	25 m	250 m

*Isolamento conforme a legge 10/91 Cap.C

*Insulation according to law 10/91 Cap.C

TB00.20 WHITE FRIO TUBO MULTISTRATO PE-Xb/Al/PE-Xb RIVESTITO BIANCO
PE-Xb/Al/PE-Xb PIPE WITH WHITE INSULATION



CODICE	i	Ø		
TB0020W162050A*	10mm	16x2.0	50 m	500m
TB0020W202013A*	13 mm	20x2.0	50 m	500m
TB0020W263050A*	13 mm	26x3.0	50 m	450m
TB0020W323025A*	13mm	32x3.0	25 m	225m

*Isolamento conforme a legge 10/91 Cap.C

NB: per il raffreddamento e la definizione degli spessori di coibentazione si consiglia di consultare un termotecnico

*Insulation according to law 10/91 Cap.C

NB: for cooling and definition of insulation thicknesses we recommend consulting a thermal engineer

TB00.20 BARS TUBO MULTISTRATO PE-Xc/Al/PE-Xc IN BARRA
PE-Xc/Al/PE-Xc PIPE IN BAR



CODICE	Ø		
TB0020H1620H4H	16x2.0	4 m	
TB0020H2020H4H	20x2.0	4 m	
TB0020H2630H4H	26x3.0	4 m	
TB0020H3230H4H	32x3.0	4 m	
TB0020H4035H4H	40x3.5	4 m	36 m
TB0020H5040H4H	50x4.0	4 m	28 m
TB0020H6345H4H	63x4.5	4 m	16 m

TB00.20 COILS TUBO MULTISTRATO PE-Xc/Al/PE-Xc IN ROTOLI
PE-Xc/Al/PE-Xc PIPE IN COILS



CODICE	i	Ø	
TB0020H16200HH	6 mm	16x2.0	100 m
TB0020H16202HH	6 mm	16x2.0	200 m
TB0020H20200HH	6 mm	20x2.0	100 m
TB0020H26300HH	6 mm	26x3.0	50 m
TB0020H32300HH	10 mm	32x3.0	50 m

TB00.20 BLUE TUBO MULTISTRATO PE-Xc/Al/PE-Xc RIVESTITO BLU
PE-Xc/Al/PE-Xc PIPE WITH BLUE INSULATION



CODICE	i	Ø	
TB0020B16200HH*	6 mm	16x2.0	50 m
TB0020B20200HH	6 mm	20x2.0	50 m
TB0020B26300HH	6 mm	26x3.0	50 m
TB0020B32300HH*	10 mm	32x3.0	25 m

*Isolamento conforme a legge 10/91 Cap.C

*Insulation according to law 10/91 Cap.C

TB00.20 RED TUBO MULTISTRATO PE-Xc/Al/PE-Xc RIVESTITO
ROSSO
PE-Xc/Al/PE-Xc PIPE WITH RED INSULATION



CODICE	i	Ø	
TB0020R16200HH*	6 mm	16x2.0	50 m
TB0020R20200HH	6 mm	20x2.0	50 m
TB0020R26300HH	6 mm	26x3.0	50 m
TB0020R32300HH*	10 mm	32x3.0	25 m

*Isolamento conforme a legge 10/91 Cap.C

*Insulation according to law 10/91 Cap.C



Tubi multistrato per gas

Multilayer pipes for gas installations



Il tubo Multistrato della serie METALGAS è contraddistinto da una struttura di 5 strati in cui uno strato di alluminio saldato testa a testa è racchiuso tra due strati di polietilene reticolato (PEX) e fissato a questi ultimi mediante due veli di adesivo.

Grazie a questa caratteristica il tubo della serie METALGAS rappresenta un perfetto connubio tra le proprietà della plastica (polietilene reticolato alta resistenza meccanica) e del metallo duttile (Alluminio alta flessibilità), in cui i pregi del PEX si sommano a quelli dell'alluminio dando vita ad un prodotto dalle straordinarie e molteplici qualità.

Il PEX conferisce resistenza chimica, resistenza alla corrosione, leggerezza, igienicità e garantisce una superficie di contatto molto liscia e levigata tale da ridurre le perdite di carico ed evitare incrostazioni.

La presenza di alluminio consente di poter modellare il tubo con estrema semplicità in modo da velocizzare notevolmente l'installazione ed impedire il passaggio d'ossigeno all'interno della condotta.

Il tubo è utilizzabile negli impianti di adduzione di gas metano o gpl ed è abbinato ai raccordi della serie TRIDENT nei sistemi di utilizzo gas proposti da General Fittings.

Multilayer pipe is characterized by a 5-layer structure in which a butt-welded aluminum layer is enclosed between two layers of cross-linked polyethylene (PEX) and fixed to the latter by two layers of adhesive.

Thanks to this feature, multilayer pipe represents a perfect combination of the properties of plastic (cross-linked polyethylene with high mechanical resistance) and ductile metal (highly flexible aluminum), in which the qualities of PEX are added to those of aluminum, giving life to a product with extraordinary and multiple qualities.

PEX confers chemical resistance, corrosion resistance, lightness, hygiene and guarantees a very smooth and polished contact surface, thus reducing pressure drops and avoiding encrustations.

The presence of aluminum makes it possible to shape the pipe with extreme simplicity in order to significantly speed up installation and prevent the passage of oxygen inside the pipeline.

The pipe can be used in methane or LPG supply systems and is combined with the fittings of the TRIDENT series in the gas use systems proposed by General Fittings.

VANTAGGI

- Ammessi per i gasdotti, nei Paesi in cui sono disponibili decreti e Certificazioni applicabili per il gas.
- Contraddistinti da specifica marcatura che riporta la pressione massima applicabile e il certificato del sistema KIWA UNI.
- Colore giallo come richiesto dalla normativa di riferimento UNI7129.
- Offrono tutti i vantaggi del metallo e della plastica.
- Anima interna del tubo in alluminio saldata longitudinalmente, 100 % a tenuta di ossigeno.
- Basso coefficiente di espansione lineare.
- Completamente resistente alla corrosione, anche contro gli influssi chimici ed elettrochimici.
- Elevata resistenza alla pressione e alla temperatura.
- Flessibile, facile da piegare.
- Il tubo mantiene la sua forma piegata anche a basse temperature.
- Idonei alla realizzazione di impianti interni per il trasporto di combustibili gassosi della I, II e III famiglia secondo la UNI EN 437, alimentati da reti di distribuzione, con pressione massima di esercizio di 0,5 bar e temperatura di esercizio da -20 °C

ADVANTAGES

- Allowed for gas pipelines, in countries where applicable decrees and certifications for gas are available.
- They bear a specific marking indicating the maximum applicable pressure and the KIWA UNI system certificate.
- Yellow colour as required by the reference standard UNI7129.
- They offer all the advantages of metal and plastic.
- Longitudinally welded aluminium tube core, 100 % oxygen-tight.
- Low coefficient of linear expansion.
- Fully corrosion-resistant, even against chemical and electrochemical influences.
- High resistance to pressure and temperature.
- Flexible, easy to bend.
- The pipe retains its bent shape even at low temperatures.
- Suitable for internal installations for the transport of gaseous fuels of families I, II and III according to EN 437, supplied by distribution networks, with a maximum operating pressure of 0.5 bar and an operating temperature of -20 °C.

CAMPI DI APPLICAZIONI E PRESTAZIONI FIELDS OF APPLICATION

APPLICAZIONI APPLICATIONS	T.sistema System T.	Pres. Max
 GAS e GPL GAS / LPG	-20°C/+70°C	0.5 MOP

COMPOSIZIONE COMPOSITION



COMPOSIZIONE STRATI LAYER COMPOSITION

Un tubo interno in polietilene reticolato, estruso con polietilene ad alta densità reticolabile. Nel METALGAS la reticolazione avviene mediante radiazioni ionizzanti (PEX-c), mentre nel METALGAS2 la reticolazione avviene mediante catalizzatore a silani (PEX-b)

An internal cross-linked polyethylene tube, extruded with cross-linkable high-density polyethylene. In METALGAS the crosslinking takes place through ionizing radiation (PEX-c), while in METALGAS2 the crosslinking takes place through a silane catalyst (PEX-b)

Uno strato di collante di elevata qualità per poter garantire un collegamento omogeneo tra il tubo in alluminio e il tubo interno in PEX

A layer of high quality glue to ensure a homogeneous connection between the aluminum pipe and the internal PE-X pipe

Un tubo in alluminio, saldato in senso longitudinale e controllato elettronicamente

An aluminum tube, longitudinally welded and electronically controlled

Uno strato di collante di elevata qualità per poter garantire un collegamento omogeneo tra il tubo in alluminio e il tubo esterno in PEX-b

A high-quality adhesive layer to ensure the homogeneous connection between the aluminium pipe and the PEX-b pipe

Un tubo esterno in polietilene reticolato mediante catalizzatore (PEX-b), estruso con polietilene ad alta densità reticolabile

An outer pipe in catalyst cross-linked polyethylene (PEX-b), extruded with cross-linkable high-density polyethylene

La parete esterna del tubo è di colore giallo

The outer layer of the pipe is yellow

CERTIFICAZIONI CERTIFICATIONS

STATO COUNTRY	CERTIFICAZIONE CERTIFICATION
	

NORMATIVE

- UNI 11344
Sistemi di tubazioni multistrato metallo plastico e raccordi per il trasporto di combustibili gassosi per impianti interni
- UNI 7129
Impianti a gas per uso domestico e similare alimentati da rete di distribuzione - Progettazione, installazione e messa in servizio

REGULATIONS

- UNI 11344
Metal-plastic multilayer piping systems and fittings for the distribution of gaseous fuels for internal plants
- UNI 7129
Gas systems for domestic and similar use powered by the distribution network - Design, installation and commissioning

**TB00.20.Y
METALGAS
BAR**

TUBO MULTISTRATO PE-Xc/Al/PE-Xb IN BARRE
PE-Xc/Al/PE-Xb PIPE IN BAR



CODICE	∅	Al		
TB0020Y202005H	20x2.0	0.4	5 m	65 m
TB0020Y263005H	26x3.0	0.6	5 m	35 m
TB0020Y323005H	32x3.0	0.8	5 m	25 m

**TB00.21.Y
METALGAS 2**

TUBO MULTISTRATO PE-Xb/Al/PE-Xb CON GUAINA
CORRUGATA
PE-Xb/Al/PE-Xb PIPE WITH CORRUGATED SHEATH



CODICE	∅			Al		
TB0021Y162552T	16x2.0	∅ 31	∅ 36	0.2	50 m	500 m
TB0021Y203052T	20x2.0	∅ 31	∅ 36	0.25	50 m	500 m
TB0021Y264052T	26x3.0	∅ 40.4	∅ 45	0.3	50 m	450 m

**TB00.20.Y
METALGAS 2
ROTOLO**

TUBO MULTISTRATO PE-X/Al/PE-X
PE-X/Al/PE-Xb PIPE



CODICE	i	∅	Al		
TB0020Y16202AT	PE-Xb/Al/PE-Xb	16x2.0	0.2	100 m	5200 m
TB0020Y20202AT	PE-Xb/Al/PE-Xb	20x2.0	0.25	100 m	1300 m
TB0020Y26302AT	PE-Xb/Al/PE-Xb	26x3.0	0.3	50 m	600 m
TB0020Y32305AT	PE-Xc/Al/PE-Xb	32x3.0	0.8	50 m	250 m



WELCOFLEX



Tubi multistrato per impianti idrotermici Multi-layer pipes for water-based heating systems

WELCOFLEX è un tubo multistrato PEX-c/Al/PEX-b di colore bianco, disponibile in rotoli. E' contraddistinto da uno strato di alluminio ad elevato spessore ed è fornito anche con isolante PE di media densità a celle chiuse di diversi spessori.

WELCOFLEX è utilizzabile in impianti idrotermici, Tipo A, classe 5.

La presenza di alluminio consente di poter modellare il tubo con estrema semplicità in modo da velocizzare notevolmente l'installazione ed impedire il passaggio d'ossigeno all'interno della condotta.

WELCOFLEX is a white PEX-c/Al/PEX-b multi-layer pipe, available in rolls. It is characterised by a high-thickness aluminium layer and is also supplied with medium-density PE insulation with closed cells of different thicknesses.

WELCOFLEX can be used in water-based heating systems, Type A, class 5.

The presence of aluminium makes it possible to shape the pipe very easily in order to greatly speed up installation and prevent the passage of oxygen inside the pipe.

VANTAGGI

- **RESISTENZA:** lo spessore dello strato intermedio d'alluminio varia da 0.4mm (DN16) a 1.5mm (DN63). L'elevato spessore dell'alluminio consente al tubo di sopportare sollecitazioni e vibrazioni dei movimenti tellurici.
- **FLESSIBILITÀ:** l'unione tra polietilene reticolato e alluminio garantisce un'ottima flessibilità in fase di piegatura. WELCOFLEX può essere piegato anche a mano con raggi di curvatura molto ridotti (1.5xDe).
- **LEGGEREZZA:** il peso specifico dei materiali che compongono il tubo sono molto bassi. A parità di diametro WELCOFLEX è sette volte più leggero di un tubo di ferro e tre volte più leggero di un tubo di rame.
- **BASSE TEMPERATURE:** WELCOFLEX può essere usato in condizioni climatiche molto rigide (-45°C), in quanto la bassa temperatura non indebolisce le caratteristiche mecano-fisiche del tubo. (Devono essere invece prese tutte le necessarie precauzioni per evitare la formazione di ghiaccio)
- **SCORREVOLEZZA:** la superficie interna del tubo è praticamente liscia e risulta esente da incrostazioni di calcare e/o ruggine. Le perdite di carico sono basse e soprattutto rimangono invariate nel tempo, non potendosi formare incrostazioni sulle pareti.
- **DURATA:** prove di laboratorio garantiscono la durata del tubo WELCOFLEX per almeno 50 anni. In questo periodo è consentito l'impiego a pressioni di 10 bar e temperature fino a 95°C con picchi massimi a 110°C.
- **DILATAZIONE:** il coefficiente di espansione lineare del tubo WELCOFLEX rimane 0.024 mm/m°K indipendentemente dal diametro del tubo. Non sono richiesti particolari dispositivi quando il tubo viene annegato nel calcestruzzo.
- **POTABILITÀ:** il tubo WELCOFLEX viene impiegato senza controindicazioni per ogni tipo di installazione dove il fluido è acqua potabile.
- **IMPERMEABILITÀ:** il rivestimento metallico saldato testa-testa costituisce una perfetta barriera al passaggio di ossigeno e luce. Il tubo è assolutamente opaco, non si ha quindi nessuna possibilità di formazione di alghe.
- **IGIENICITÀ:** per svilupparsi le alghe richiedono la presenza di raggi ultravioletti. Lo strato di alluminio protegge lo strato interno dalle radiazioni UV e previene quindi la formazione di alghe.
- **RESISTENZA ALLA CORROSIONE:** la superficie non viene corrosa e non si staccano particelle arrugginite. Lo strato esterno in PEX protegge contro l'azione corrosiva di alcune malte cementizie e contro possibili deterioramenti meccanici.
- **RESISTENTE ALL'ABRASIONE INTERNA** dovuta all'azione abrasiva, specialmente nelle curve, delle

ADVANTAGES

- **STRENGTH:** the thickness of the intermediate aluminium layer varies from 0.4 mm (DN16) to 1.5 mm (DN63). The elevated thickness of the aluminium allows the pipe to withstand the stresses and vibrations of seismic activity.
- **FLEXIBILITY:** the union of cross-linked polyethylene and aluminium guarantees excellent flexibility when bending. WELCOFLEX can also be bent by hand with very small bending radii (1.5xDe).
- **LIGHTNESS:** the specific weights of the materials that make up the pipe are very low. Assuming the same diameter, WELCOFLEX is seven times lighter than iron pipe and three times lighter than copper pipe.
- **LOW TEMPERATURES:** WELCOFLEX can be used in very harsh climatic conditions (-45°C) as low temperatures do not weaken the mechanical and physical characteristics of the pipe. (However, all necessary precautions must be taken to avoid the formation of ice)
- **SMOOTHNESS:** the inner surface of the pipe is practically smooth and free of limescale and/or rust. Pressure drops are low and above all remain unchanged over time, as no encrustations can form on the walls.
- **DURABILITY:** laboratory tests guarantee that WELCOFLEX pipe will last for at least 50 years. During this period, it can be used at pressures of 10 bar and temperatures up to 95°C with maximum peaks at 110°C.
- **EXPANSION:** the linear expansion coefficient of WELCOFLEX pipe remains 0.024 mm/m°K, regardless of its diameter. No special devices are required when the pipe is covered in concrete.
- **POTABILITY:** there are no special precautions in relation to the use of WELCOFLEX piping for any type of installation where the fluid is drinking water.
- **WATERPROOF:** the head-to-head welded metal coating is a perfect barrier to the passage of oxygen and light. The pipe is absolutely opaque, so there is no possibility of algae formation.
- **CLEANLINESS:** in order for algae to grow, the presence of ultraviolet rays is required. The aluminium layer protects the inner layer from UV radiation and thus prevents the formation of algae.
- **CORROSION RESISTANCE:** the surface does not become corroded and no rusty particles detach. The PEX outer layer protects against the corrosion that can be caused by some cement mortars and against possible mechanical deterioration.
- **RESISTANT TO INTERNAL ABRASION** due to the abrasive action of impurities suspended in the carrier fluid (especially in bends), even when the flow rate is





impurità presenti in sospensione nel fluido vettore, anche quando la velocità di scorrimento è molto elevata.

- **IGNIFUCIGITA'**: lo strato metallico rende il tubo difficilmente infiammabile, la combustione può comunque avvenire, sviluppando un fumo poco denso (classe 1).
- **INSONORIZZAZIONE**: buone proprietà fonoassorbenti per i rumori causati dal funzionamento di elettropompe e dallo scorrimento del fluido. Il rivestimento in PE-X interno ed esterno attenua i suoni non assorbiti dallo strato metallico.
- **RICICLABILITÀ**: Il tubo multistrato WELCOFLEX è completamente riciclabile; eventuali spezzoni residui, inutilizzabili, possono venir riciclati ed impiegati per altri scopi.
- Utilizzabile in **INSTALLAZIONI MISTE**.

very high.

- **FIRE RESISTANCE**: the metal layer makes the pipe difficult to ignite, but combustion can still take place, developing a thin smoke (class 1).
- **SOUNDPROOFING**: good sound-absorbing properties for noises caused by the operation of electric pumps and fluid flow. The inner and outer PE-X coating attenuates sounds not absorbed by the metal layer.
- **RECYCLABILITY**: WELCOFLEX multi-layer pipe is completely recyclable; any unusable residual fragments can be recycled and used for other purposes.
- Can be used in **MIXED INSTALLATIONS**.

CAMPI DI APPLICAZIONI E PRESTAZIONI FIELDS OF APPLICATION

APPLICAZIONI APPLICATIONS		T. di sistema T. of the system	Press.max Max. pressure
	acqua potabile drinking water	-45°C/+90°C	10 bar
	acqua calda sanitaria sanitary hot water	-45°C/+90°C	10 bar
	radiatori radiators	-45°C/+90°C	10 bar
	riscaldamento a pavimento floor heating	-45°C/+90°C	10 bar
	irrigazione irrigation	-45°C/+90°C	10 bar

COMPOSIZIONE DEL TUBO NUDO COMPOSITION OF BARE PIPE



COMPOSIZIONE STRATI LAYER COMPOSITION

Strato interno in polietilene HD (alta densità) reticolato con il sistema elettronico PE-Xc
Inner layer in HD (high density) polyethylene cross-linked with the PE-Xc electronic system

Uno strato di collante di elevata qualità per poter garantire un collegamento omogeneo tra il tubo in alluminio e il tubo interno in PEX-c
A high-quality adhesive layer to ensure the homogeneous connection between the aluminium pipe and the PEX-c inner pipe

Strato in alluminio saldato longitudinale testa-testa, spessore da 0,4 mm (tubo 14x2.0) a 1.5 mm (tubo 63x4.5).
Longitudinal head-head welded aluminium layer, from 0.4 mm (14x2.0 pipe) to 1.5 mm (63x4.5 pipe) in thickness.

Uno strato di collante di elevata qualità per poter garantire un collegamento omogeneo tra il tubo in alluminio e il tubo esterno in PE-Xb
A high-quality adhesive layer to ensure the homogeneous connection between the aluminium pipe and the PE-Xb outer pipe

Strato esterno in polietilene reticolato PE-Xb
Outer layer in PE-Xb cross-linked polyethylene

COMPOSIZIONE DEL TUBO RIVESTITO COATED PIPE COMPOSITION

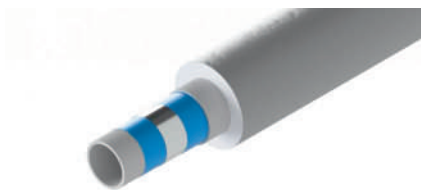

COMPOSIZIONE STRATI LAYER COMPOSITION

Strato interno in polietilene HD (alta densità) reticolato con il sistema elettronico PE-Xc
Inner layer in HD (high density) polyethylene cross-linked with the PE-Xc electronic system

Uno strato di collante di elevata qualità per poter garantire un collegamento omogeneo tra il tubo in alluminio e il tubo interno in PEX-c
A high-quality adhesive layer to ensure the homogeneous connection between the aluminium pipe and the PEX-c inner pipe

Strato in alluminio saldato longitudinale testa-testa, spessore da 0,4 mm (tubo 14x2.0) a 1.5 mm (tubo 63x4.5).
Longitudinal head-head welded aluminium layer, from 0.4 mm (14x2.0 pipe) to 1.5 mm (63x4.5 pipe) in thickness.

Uno strato di collante di elevata qualità per poter garantire un collegamento omogeneo tra il tubo in alluminio e il tubo esterno in PEX-b
A high-quality adhesive layer to ensure the homogeneous connection between the aluminium pipe and the PEX-b pipe

Strato esterno in polietilene reticolato PE-Xb
Outer layer in PE-Xb cross-linked polyethylene

Rivestimento: strato di materiale coibentante, realizzato in polietilene di media densità a cellule chiuse, che incrementa l'efficienza energetica dell'installazione, e migliora ulteriormente la già ridotta rumorosità.
Coating: layer of insulation made of closed-cell medium-density polyethylene, which increases the energy efficiency of the system, and further reduces noise.

POLIETILENE RETICOLATO (PEX)

Il polietilene è un materiale polimerico termoplastico composto da numerose molecole lunghe che, anche a temperature moderatamente elevate (ancora sotto il punto di fusione), comincia ad avere un significativo grado di fluidità.

Con il processo di reticolazione le molecole di polietilene si legano insieme per formare una struttura tridimensionale più complessa: la reazione chimica di reticolazione trasforma infatti il prodotto da termoplastico a termoisolante.

Il materiale subisce una modificazione strutturale che ne migliora le caratteristiche quali l'abrasione, la resistenza chimica, la resistenza meccanica nel tempo, la resistenza all'invecchiamento e alle alte temperature. Le prestazioni meccaniche del materiale vengono incrementate significativamente.

Il polietilene reticolato può essere prodotto mediante tecnologie diverse riconosciute dalle norme internazionali e identificate con i metodi A (perossidi), B (silani), C (radiazioni). Il metodo utilizzato viene indicato dopo la sigla del materiale ottenendo rispettivamente PE-Xa, PE-Xb, PE-Xc.

Tutti i metodi sopracitati valgono: non è il processo di reticolazione che definisce la bontà del prodotto, bensì la sua capacità di superare i test fisici e meccanici definiti dalle norme.

Nel caso del PE-Xc lo strato di PE viene reticolato elettronicamente in modo uniforme su tutto lo spessore; i raggi gamma innescano il processo di reticolazione senza alcun residuo tossico e/o dannoso. L'uniformità del grado

CROSS-LINKED POLYETHYLENE (PEX)

Polyethylene is a thermoplastic polymeric material composed of numerous long molecules that, even at moderately high temperatures (still below the melting point), begins to have a significant degree of fluidity. With the cross-linking process, the polyethylene molecules are bonded together to form a more complex three-dimensional structure: the chemical cross-linking reaction transforms the product from thermoplastic to thermosetting.

The material undergoes a structural modification that improves its characteristics such as abrasion, chemical resistance, mechanical resistance over time, resistance to ageing and high temperatures. The mechanical performance of the material is significantly increased.

Cross-linked polyethylene can be produced by different technologies recognised by international standards and identified by methods A (peroxides), B (silanes), and C (radiation). The method used is indicated after the abbreviation of the material: PE-Xa, PE-Xb, PE-Xc.

All the above methods are valid: it is not the cross-linking process that defines the quality of the product, but its ability to pass the physical and mechanical tests defined by the standards.

In the case of PE-Xc, the PE layer is electronically cross-linked uniformly over the entire thickness; gamma rays trigger the cross-linking process without any toxic and/or harmful residues. The uniformity of the degree of cross-linking increases the strength of the PE-X layer and thus of the pipe.

The PEX-b outer layer ensures high resistance to breakage

di reticolazione aumenta la resistenza dello strato di PE-X e quindi del tubo.

Lo strato esterno in PEX-b consente elevata resistenza alla rottura ed offre grande e permanente protezione allo strato di alluminio sottostante. Inoltre, la tubazione che è spesso sottoposta ad elevate sollecitazioni sia durante il trasporto, sia durante l'installazione viene protetta dallo strato esterno, dall'abrasione e dall'usura.

IMPERMEABILITA'

Il rivestimento metallico costituisce una perfetta barriera al passaggio di molecole gassose: nessun pericolo di corrosione dovuto all'infiltrazione di ossigeno.

Lo strato d'alluminio viene saldato di testa con il sistema WIG: lo strato metallico non ha quindi la sola funzione di rendere impermeabile la tubazione ma consente di sopportare adeguatamente le sollecitazioni termiche e di pressione, presenti soprattutto negli impianti sanitari.

TUBO PREISOLATO IN ROTOLI

Alcuni diametri di tubo WELCOFLEX in rotoli, vengono anche forniti completi di isolamento.

Questo isolamento viene realizzato in polietilene di media densità a celle chiuse, avente una conduttività termica (certificata CSI) di 0,040 W/m²K con densità di 21,4 kg/m³.

L'indice d'impermeabilità dell'isolante (certificato CSI) rilevato, ha un valore medio di $\mu = 11450$ (rilevato su tre provini) mentre la deviazione standard $\mu = 614$.

L'isolante è protetto da un film in polietilene a bassa densità, resistente agli strappi. La classe di resistenza al fuoco è 1.

L'isolante non ha come unica funzione la coibenza termica ma anche l'attenuazione della rumorosità, inoltre, assorbe senza alcun danno gli allungamenti dovuti alla dilatazione, ed è quindi consigliabile nei casi in cui il tubo viene inserito nella parete o sotto il pavimento.

and offers advanced and permanent protection to the underlying aluminium layer. In addition, the pipe (often subjected to high stresses both during transport and installation) is protected from abrasion and wear by the outer layer.

WATERPROOFING

The metal coating of the pipe is a perfect barrier to the passage of gaseous molecules: that means no risk of corrosion due to oxygen infiltration.

The aluminium layer is welded at the head with the WIG system: the metal layer therefore not only serves to make the pipe waterproof, but also to adequately withstand thermal and pressure stresses, especially in sanitary installations.

PRE-INSULATED PIPE IN ROLLS

Some diameters of WELCOFLEX pipe in rolls also come complete with insulation.

This insulation is made of closed cell medium density polyethylene with thermal conductivity (CSI certified) of 0.040 W/m²K with a density of 21.4 kg/m³.

The insulation impermeability index (CSI certificate) detected has an average value of $\mu = 11450$ (based on three samples) while the standard deviation is $\mu = 614$.

The insulation is protected by a tear-resistant, low-density polyethylene film. The fire resistance class is 1.

The sole function of the insulation is not only thermal insulation, but also the attenuation of noise; in addition, it absorbs elongations due to expansion without damaging the pipe, and is therefore advisable in cases where the pipe is placed inside the wall or under the floor.

NORMATIVE

I tubi WELCOFLEX sono conformi alla seguenti normative e disposizioni:

- UNI 10954-1
- DVGW (U448)
- Decreto Ministeriale 21 Marzo 1973
- Decreto Ministeriale n° 220 26 Aprile 1993
- Circolare n° 102 alleg. II, parte A, parte B Gazzetta Ufficiale 1978
- Legge 46/90 norme per la sicurezza degli impianti
- D.P.R. 447 del 6/12/91
- Legge 10/91
- Decreto Legislativo n° 174 6 Aprile 2004

CERTIFICAZIONI

Il tubo WELCOFLEX viene provato secondo le nuove disposizioni EW542 del DVGW e registrato con il numero U448 che garantisce la perfetta qualità igienica del tubo.

RACCORDERIA

I tubi WELCOFLEX sono utilizzabili con i raccordi a stringere WOFLEX e con i raccordi a pressare EWOPREX. Si consiglia di fare riferimento al catalogo commerciale o al sito www.generalfittings.it.

REGULATIONS

WELCOFLEX pipes comply with the following regulations and provisions:

- UNI 10954-1
- DVGW (U448)
- Italian Ministerial Decree of 21 March 1973
- Italian Ministerial Decree No. 220 of 26 April 1993
- Ministerial Memorandum no. 102, enclosure . II, part A, part B, in Italy's Official Gazette 1978
- Italian Law 46/90: rules for the safety of systems
- Italian Presidential Decree 447 of 6/12/91
- Italian Law 10/91
- Italian Legislative Decree No. 174 of 6 April 2004

CERTIFICATIONS

WELCOFLEX pipes are tested according to the new DVGW EW542 provisions and registered under the number U448, which guarantees the perfect hygienic quality of the pipe.

FITTINGS

WELCOFLEX pipes can be used with WOFLEX compression fittings and EWOPREX press fittings. Please refer to the sales catalogue or www.generalfittings.it.

**TB00.20
COILS**TUBO MULTISTRATO PE-Xc/Al/PE-Xb IN ROTOLI
PE-Xc/Al/PE-Xb PIPE IN COILS

CODICE	Ø	Al	
TB0020H162210Z	16x2.25	0.4	100 m
TB0020H202510Z	20x2.5	0.5	100 m

TB00.20 BARS TUBO MULTISTRATO PE-Xc/Al/PE-Xb IN BARRE
PE-Xc/Al/PE-Xb PIPE IN BAR

CODICE	Ø	Al	
TB0020H162205Z	16x2.25	0.4	5 m
TB0020H202505Z	20x2.50	0.5	5 m

TB00.20 GREY TUBO MULTISTRATO PE-Xc/Al/PE-Xb RIVESTITO
GRIGIO
PE-Xc/Al/PE-Xb PIPE WITH GREY INSULATION

CODICE	i	Ø	Al	
TB0020G162250Z	Isol. 6 mm	16x2.25	0.4	50 m
TB0020G202550Z	Isol. 6 mm	20x2.5	0.5	50 m



ACCESSORI PER SISTEMI PER TUBO MULTISTRATO MULTILAYER PIPE SYSTEMS ACCESSORIES

General Fittings propone una vasta gamma di accessori e attrezzature per la realizzazione di impianti con tubazioni multistrato.

General Fittings offers a wide range of accessories and tools for the installation of multilayer pipe systems.

PZ56.00 PRESSATRICE MANUALE
MANUAL PRESS MACHINE



CODICE

∅

PZ5600H162000H

16-18-20

AC00.80 INSERTO PER PRESSATRICE MANUALE
MANUAL ADAPTER FOR MANUAL PRESS MACHINE



CODICE

i

∅

AC0080T160001H

TH

16

AC0080T180001H

TH

18

AC0080T200001H

TH

20

AC0080U160001H

U

16

AC0080U180001H

U

18

AC0080U200001H

U

20

AC00.93 VALIGETTA CON SET CALBRATORI/SBAVATORI
PLASTIC CASE WITH DEBURRING TOOLS SET



CODICE

∅

AC0093H162600A

16-20-26

CS50.00 CALIBRO SBAVATORE
REAMER/DEBURRER



CODICE

∅

CS5000H142000A

14x2.0

CS5000H162000A

16x2.0

CS5000H162200A

16x2.25

CS5000H182000A

18x2.0

CS5000H202000A

20x2.0

CS5000H202500A

20x2.25

CS5000H263000A

26x3.0

CS5000H323000A

32x3.0

CS5000H403500A

40x3.5

CS5000H504000A

50x4.0

CS5000H634500A

63x4.5

CS50.00_ CALIBRO SBAVATORE
REAMER/DEBURRER



CODICE	i	Ø
CS5000B162026A	Blu	16x2.0-20x2.0-26x3.0
CS5000R162026A	Rosso	16x2.0-20x2.0-26x3.0

MA00.90 MANIGLIA PER CALIBRO CS50.00
HANDLE FOR CS50.00



CODICE	Ø
MA0090N500000H	T

AC00.80 MOLLA MOLLA PIEGATUBI (KIT 16/20/26)
BENDER SPRING (KIT 16/20/26)



CODICE	Ø
AC0080HSETMOLH	500 mm

TT50.00 ROTELLA TAGLIATUBI A ROTELLA DA Ø14 A Ø26
WHEEL PIPE CUTTER FROM Ø14 TO Ø26



CODICE
TT5000H142600H

TT50.00 CESCOIA TAGLIATUBI A CESCOIA TC 0-42 MM
SHEARS PIPE CUTTER TC 0-42MM



CODICE
TT5000HROCU42H

AC00.80 MINI PINZE PER MACCHINA PRESSATRICE MINI -
PROFILO TH
JAW FOR MINI PRESS MACHINE - TH PROFILE



CODICE	Ø
AC0080T16019JH	16
AC0080T20019JH	20
AC0080T26019JH	26
AC0080T32019JH	32

AC00.80 BIG PINZE PER MACCHINA PRESSATRICE BIG - PROFILO TH
 TH
 JAW FOR BIG PRESS MACHINE - TH PROFILE



CODICE	Ø
AC0080T16032JH	16
AC0080T20032JH	20
AC0080T26032JH	26
AC0080T32032JH	32
AC0080T40032JH	40

AC00.80 BIG - CATENA - PINZE A CATENA PER MACCHINA PRESSATRICE BIG
 - PROFILO TH
 JAW FOR BIG PRESS MACHINE - TH PROFILE



CODICE	Ø
AC0080T50C32JH	50
AC0080T63C32JH	63

AC00.91 MINI MACCHINA PRESSATRICE MINI-completa di ganasce
 Ø 16-20-26
 MINI PRESS MACHINE-with jaws Ø 16-20-26



CODICE	Ø
AC0091HJBSPM19	16-20-26
Compatibile con Ø 16-20-26-32	
Compatible with Ø 16-20-26-32	

AC00.91 BIG MACCHINA PRESSATRICE BIG-completa di ganasce
 Ø 16-20-26
 BIG PRESS MACHINE - with jaws Ø 16-20-26



CODICE	Ø
AC0091HJBSMP32	16-20-26
Compatibile con ganasce Ø 16-20-26-32-40-50-63	
Compatible with jaws Ø 16-20-26-32-40-50-63	

AC00.92 RICAMBIO BATTERIA MACCHINE PRESSATRICI (BIG E MINI)
PRESSING MACHINE BATTERY REPLACEMENT (BIG AND MINI)



CODICE

AC0092HJBB1830

AC00.92 CARICA BATTERIA LI-ION 3,0AH/18V (BIG E MINI)
BATTERY CHARGE LI-ION 3,0AH/18V (BIG AND MINI)



CODICE

AC0092HJBC1830

5F00.R3 KIT VALVOLA COMPLETO DI SCATOLA AD INCASSO CON ATTACCHI DAL BASSO - SEDE CONICA
VALVE KIT FEATURING SIDE FLUSH MOUNT BOX - CONICAL SEAT



CODICE

5F00R3H0500U1H



3/4"

5F00.04 PLACCA DI COPERTURA BIANCA
WHITE COVER PLATE



CODICE



5F0004WB01000H	per art. 5F00.03/5F00.R3	135x90
5F0004WC01000H	per art. 5F00.61 (2 vie)	196x120
5F0004WD01000H	per art. 5F00.61 (3 vie)	230x140

5F00.61 COLLETTORE COMPLETO DI SCATOLA AD INCASSO-SEDE CONICA
MANIFOLD FEATURING FLUSH MOUNT BOX - CONICAL SEAT



CODICE



5F0061H100502H	2	1"x3/4
5F0061H100503H	3	1"x3/4

5F00.04.C PLACCA DI COPERTURA CROMATA
CHROME-PLATED COVER PLATE



CODICE



5F0004CB01000H	per art. 5F00.03/5F00.R3	135x90
----------------	--------------------------	--------

5F00.05 RACCORDO DI USCITA PER UTENZE COMPLETO DI SCATOLA AD INCASSO E PLACCA DI COPERTURA
 USER OUTPUT FITTING FEATURING FLUSH MOUNT BOX AND COVER PLATE



CODICE	Ø
--------	---

5F0005H050001H	1/2"x3/4"
----------------	-----------

AC00.80 GAS CASSETTA COLLETORE GAS
 MANIFOLD BOX

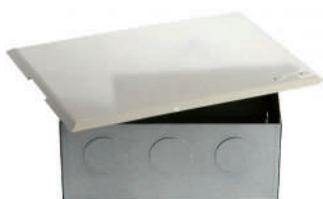

CODICE	Ø
--------	---

AC0080H050200H	180x140x75
----------------	------------

AC0080H050300H	230x180x75
----------------	------------

5F00.80 ADATTATORE PIANO PER SEDE CONICA (O-RING INCLUSO)
 CONICAL SEAT ADAPTOR (O-RING INCLUDED)



CODICE	Ø
--------	---

5F0080H050000H	3/4"
----------------	------

5F0080H100000H	1"
----------------	----

Idoneo ad essere utilizzato con gli articoli: 5F00.N6 - 5F00.N7 - 5F00.61 - 5F00.03 - 5F00.05

Suitable for use with articles: 5F00.N6 - 5F00.N7 - 5F00.61 - 5F00.03 - 5F00.05

5F00.03 KIT VALVOLA COMPLETO DI SCATOLA AD INCASSO CON ATTACCO LATERALE - SEDE CONICA
 VALVE KIT FEATURING SIDE FLUSH MOUNT BOX - CONICAL SEAT



CODICE	Ø
--------	---

5F0003H050001H	3/4"
----------------	------

COLLETTORI DI
DISTRIBUZIONE
DISTRIBUTION
MANIFOLDS

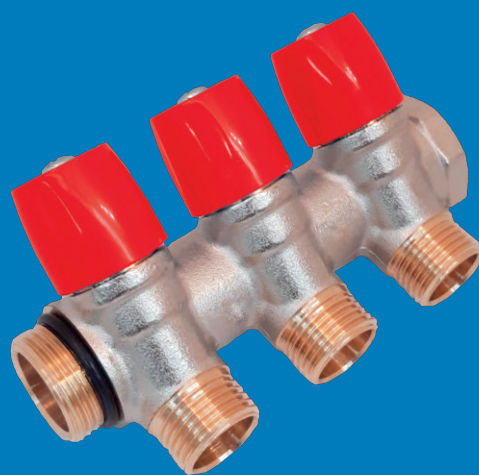



FLEXUS



Collettori di distribuzione fasati Self-aligned manifolds

I collettori FLEXUS sono una soluzione semplice ed essenziale per un'efficace distribuzione sanitaria. La fasatura dei filetti consente di assemblare più collettori senza l'ausilio di alcun sigillante, garantendo sempre l'allineamento delle uscite. Sono disponibili sia con mini valvole (6200.R6) che con vitoni (6200 e 6300). Sono utilizzabili per la realizzazione di impianti di riscaldamento, raffrescamento e sanitari. La configurazione dei collettori consente la realizzazione di circuiti caldi e/o freddi in parallelo.

FLEXUS manifolds are suitable for heating and sanitary water distribution. Self aligning grants the aligning of the coupled manifolds without using any additional means, such as teflon tape or hemp. They are available with screws (6200 and 6300) or with mini valves (6200.R6). Flexus manifolds are suitable for sanitary, heating and cooling installations. Their configuration allows the realization of hot and/or cold circuits in parallel.





VANTAGGI

- Fasatura filetti: composizione allineata
- Interasse costante
- Garanzia di tenuta senza sigillanti grazie all'O-Ring: rapidità d'installazione
- Non serve utilizzare la canapa o altri sigillanti
- Idoneità al contatto con acqua potabile
- Rintracciabilità garantita dal datario impresso sul corpo del collettore (solo per 6200.E7)
- Collarino rinforzato
- Materie prime impiegate di alta qualità [UBA LIST]
- Adatti a tutte le tipologie di tubo plastico, metallo e metallo-plastico
- Disponibile versione con vitoni o con mini valvole
- Doppia tenuta O-Ring che garantisce una maggiore tenuta idraulica
- Riduzione degli ingombri

ADVANTAGES

- *Self-aligning granting the correct and quick aligning of the coupled manifolds*
- *Constant center distance*
- *Perfectly tight: thanks to the O-Ring the coupling is tight without using any additional means, such as Teflon tape or hemp, for a faster installation*
- *No need to use hemp or other sealants*
- *Suitable for drinking water*
- *Product traceability guaranteed by the date stamped on the body of the manifold (only for 6200.E7)*
- *Reinforced collar*
- *Raw materials complying with UBA LIST*
- *Suitable for plastic, metal and metal-plastic pipes*
- *Available with screws and mini valves*
- *Double O-Ring seal for improved tightness*
- *Encumbrances reduction*

CAMPI DI APPLICAZIONI E PRESTAZIONI FIELDS OF APPLICATION

APPLICAZIONI APPLICATIONS		T. min.	T. max	T.di sistema T.of the system	Press.max Max. pressure
	acqua potabile drinking water	-20°C	+120°C	-20°C +95°C	10 bar
	acqua calda sanitari hot sanitary water	-20°C	+120°C	-20°C +95°C	10 bar
	raffrescamento cooling	-20°C	+120°C	-20°C +95°C	10 bar
	radiatori radiators	-20°C	+120°C	-20°C +95°C	10 bar

-20°C: solo con liquido antigelo, glicole, in % max del 30%
-20°C: only with antifreeze liquid (glycol) in % max of 30%

DISCHETTI UTENZE DESTINATION LABELS

I collettori Flexus vengono forniti con appositi dischetti utenze identificative dell'utilizzo acqua calda/fredda (rosso-blu) e della zona di utilizzo.

Flexus manifolds are supplied with hot/cold water (red/blue) and zone of use identification labels.



DOPPIA TENUTA O-RING DOUBLE O-RING SEAL



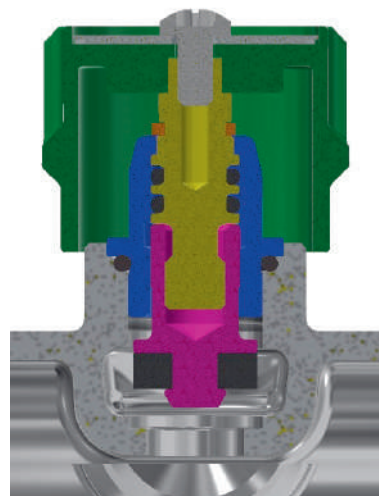

I collettori FLEXUS sono caratterizzati dalla presenza di una doppia tenuta O-Ring che garantisce una maggiore tenuta idraulica.

FLEXUS manifolds are characterised by the presence of a double O-ring seal, which guarantees an increased tightness.

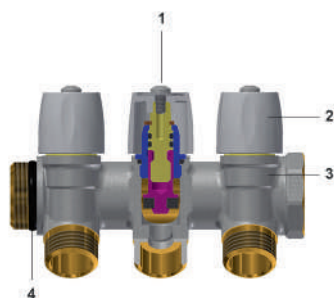







COMPONENTI E MATERIALI 6200.E7 - 6300.E7 6200.E7 - 6300.E7: COMPONENTS AND MATERIALS

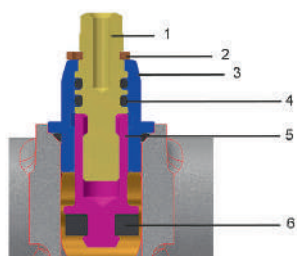

LEGENDA LEGEND	COMPONENTI COMPONENTS	MATERIALI MATERIALS
	1 Vite Screw	Acciaio CB4F Steel CB4F
	2 Manopola Knob	ABS
	3 Corpo Body	CW617N - UNI EN 12165 Brass CW617N - UNI EN 12165
	4 O-Ring per fasatura Self-seal O-Ring	Elastomero per acqua potabile Elastomer for drinking water







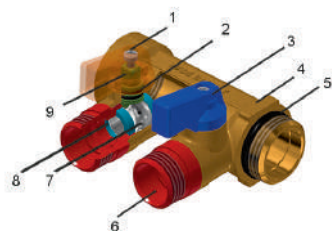

COMPONENTI E MATERIALI VITONE (6200.E7-6300.E7) 6200.E7-6300.E7: SCREW COMPONENTS AND MATERIALS



LEGENDA LEGEND	COMPONENTI COMPONENTS	MATERIALI MATERIALS
	1 Asta superiore Top stem	CW617N - UNI EN 12164 Brass CW617N - UNI EN 12164
	2 Forcella di fermo Stop fork	Bronzo fosforoso Phosphor bronze
	3 Corpo Vitone Body	CW617N - UNI EN 12164 Brass CW617N - UNI EN 12164
	4 O-Ring	Elastomero per acqua potabile Elastomer for drinking water
	5 Asta inferiore Bottom stem	CW617N - UNI EN 12164 Brass CW617N - UNI EN 12164
	6 Guarnizione piatta Flat gasket	Elastomero per acqua potabile Elastomer for drinking water

COMPONENTI E MATERIALI 6200.R6 6200.R6: COMPONENTS AND MATERIALS



LEGENDA LEGEND	COMPONENTI COMPONENTS	MATERIALI MATERIALS
	1 Vite Screw	Fe zincato Fe galvanized
	2 O-Ring	Elastomero per acqua potabile Elastomer for drinking water
	3 Leva Lever	Alluminio Aluminium
	4 Corpo collettore Body	CW617N - UNI EN 12165 Brass CW617N - UNI EN 12165
	5 O-Ring per fasatura Self-seal O-Ring	Elastomero per acqua potabile Elastomer for drinking water
	6 Bocchettone Straight union	CW617N - UNI EN 12165 Brass CW617N - UNI EN 12165
	7 Sfera Ball	CW617N cromato CW617N chromed
	8 Guarnizione sfera Ball seal	Elastomero per acqua potabile Elastomer for drinking water
	9 Asta di manovra Stem	CW617N - UNI EN 12164 Brass CW617N - UNI EN 12164

GUIDA ALLE CONNESSIONI 6200.E7

6200.E7: CONNECTION GUIDE

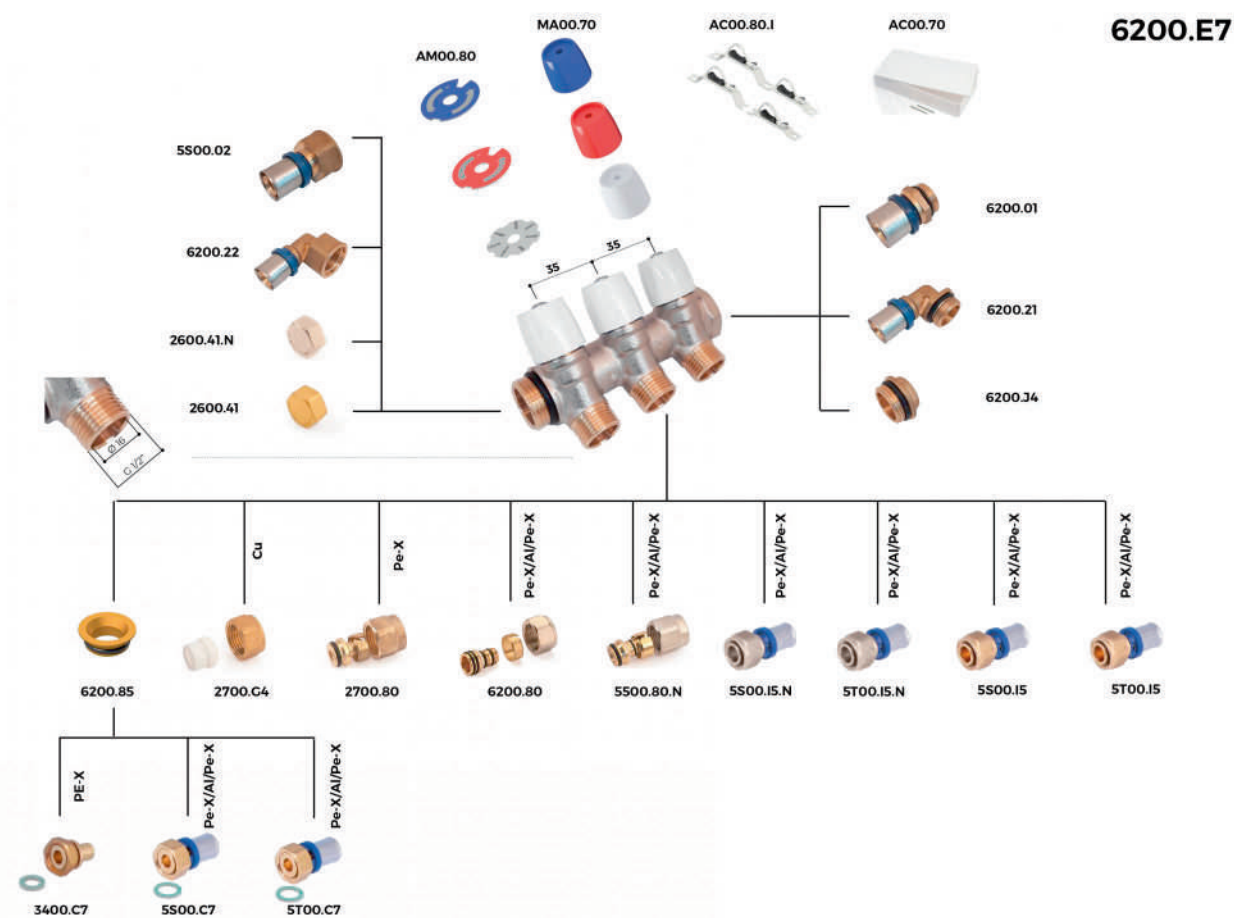

INSERTI E RACCORDI INSERTS AND FITTINGS

CODICE CODE	DESCRIZIONE DESCRIPTION	TUBO PIPE
AM00.80	Dischetto utenze Destination label	
MA00.70	Manopola Knob	
AC00.80.I	Staffa Per collettori Flexus Bracket for Flexus manifolds	
AC00.70	Cassetta collettore Manifold cabinet	
6200.85	Adattatore sede piana Flat seal adapter	
2700.G4	Dado e monocono P.T.F.E Nut and monocone P.T.F.E	tubo rame copper pipe
2700.80	Dado, ogiva e inserto Nut, olive and insert	tubo Pe-X Pe-X pipe
6200.80	Dado nichelato, ogiva ed inserto Nickel-plated nut, olive and insert	tubo multistrato multilayer pipe
5500.80.N	Dado nichelato, ogiva ed inserto Nickel-plated nut, olive and insert	tubo multistrato multilayer pipe
5T00.I5	Raccordo dritto sede conica O-Ring con girello- Straight fitting with loose nut and conical connection	tubo multistrato multilayer pipe
5500.I5	Raccordo dritto sede conica O-Ring con girello- Straight fitting with loose nut and conical connection	tubo multistrato multilayer pipe

INSERTI E RACCORDI INSERTS AND FITTINGS		
5T00.I5.N	Raccordo dritto nichelato sede conica O-Ring con girello- Nickel plated straight fitting with loose nut and conical connection	tubo multistrato multilayer pipe
5500.I5.N	Raccordo dritto nichelato sede conica O-Ring con girello- Nickel plated straight fitting with loose nut and conical connection	tubo multistrato multilayer pipe
6200.01	Raccordo dritto maschio con O-Ring Male straight fitting with O-Ring	
6200.21	Angolo maschio fasato con O-Ring Self-seal male elbow with O-Ring	
5500.02	Raccordo diritto femmina Female straight fitting	
6200.22	Angolo femmina fasato Self-seal female elbow with O-Ring	
2600.41/41.N	Tappo femmina / tappo femmina nichelato Female cap / Nickel plated female cap	
6200.J4	Tappo maschio con O-Ring Male cap with O-Ring	
3400.C7	Raccordo diritto sede piana con girello con guarnizione Straight fitting with loose nut and flat washer	tubo Pe-X Pe-X pipe
5500.C7	Raccordo diritto sede piana con girello con guarnizione Straight fitting with loose nut and flat washer	tubo multistrato multilayer pipe
5T00.C7	Raccordo diritto sede piana con girello con guarnizione Straight fitting with loose nut and flat washer	tubo multistrato multilayer pipe

GUIDA ALLE CONNESSIONI 6200.R6

6200.R6: CONNECTION GUIDE

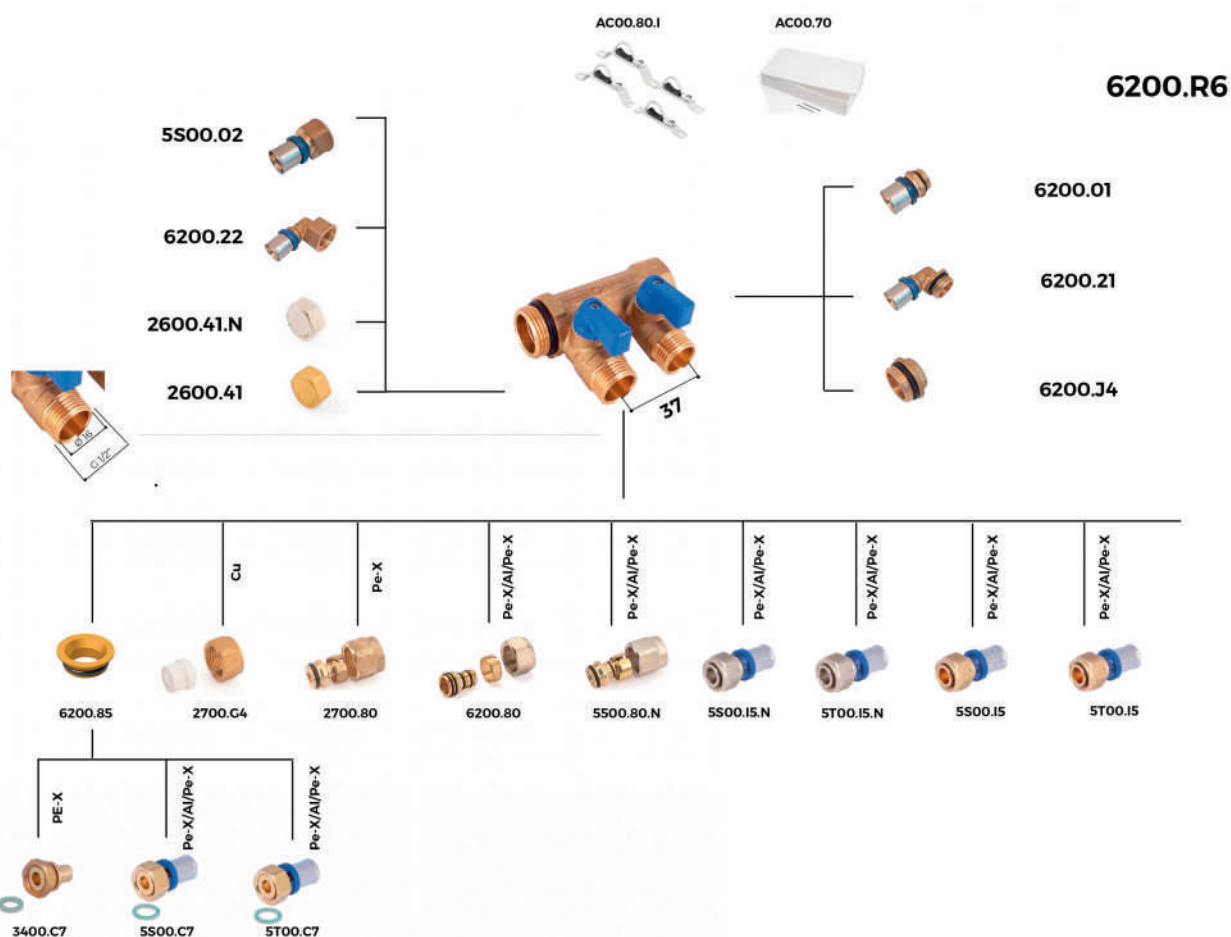

INSERTI E RACCORDI INSERTS AND FITTINGS

CODICE CODE	DESCRIZIONE DESCRIPTION	TUBO PIPE
AC00.80.I	Staffa Per collettori Flexus Bracket for Flexus manifolds	
AC00.70	Cassetta collettore Manifold cabinet	
6200.85	Adattatore sede piana Flat seal adapter	
2700.G4	Dado e monocono P.T.F.E Nut and monocone P.T.F.E	tubo rame copper pipe
2700.80	Dado, ogiva e inserto Nut, olive and insert	tubo Pe-X Pe-X pipe
6200.80	Dado nichelato, ogiva ed inserto Nickel-plated nut, olive and insert	tubo multistrato multilayer pipe
5500.80.N	Dado nichelato, ogiva ed inserto Nickel-plated nut, olive and insert	tubo multistrato multilayer pipe
5T00.I5	Raccordo dritto sede conica O-Ring con girello- Straight fitting with loose nut and conical connection	tubo multistrato multilayer pipe
5500.I5	Raccordo dritto sede conica O-Ring con girello- Straight fitting with loose nut and conical connection	tubo multistrato multilayer pipe
5T00.I5.N	Raccordo dritto nichelato sede conica O-Ring con girello- Nickel plated straight fitting with loose nut and conical connection	tubo multistrato multilayer pipe

INSERTI E RACCORDI INSERTS AND FITTINGS		
5500.I5.N	Raccordo dritto nichelato sede conica O-Ring con girello- Nickel plated straight fitting with loose nut and conical connection	tubo multistrato multilayer pipe
6200.01	Raccordo dritto maschio con O-Ring Male straight fitting with O-Ring	
6200.21	Angolo maschio fasato con O-Ring Self-seal male elbow with O-Ring	
5500.02	Raccordo diritto femmina Female straight fitting	
6200.22	Angolo femmina fasato Self-seal female elbow with O-Ring	
2600.41/41.N	Tappo femmina / tappo femmina nichelato Female cap / Nickel plated female cap	
6200.J4	Tappo maschio con O-Ring Male cap with O-Ring	
3400.C7	Raccordo diritto sede piana con girello con guarnizione Straight fitting with loose nut and flat washer	tubo Pe-X Pe-X pipe
5500.C7	Raccordo diritto sede piana con girello con guarnizione Straight fitting with loose nut and flat washer	tubo multistrato multilayer pipe
5T00.C7	Raccordo diritto sede piana con girello con guarnizione Straight fitting with loose nut and flat washer	tubo multistrato multilayer pipe

GUIDA ALLE CONNESSIONI 6300.E7 6300.E7: CONNECTION GUIDE

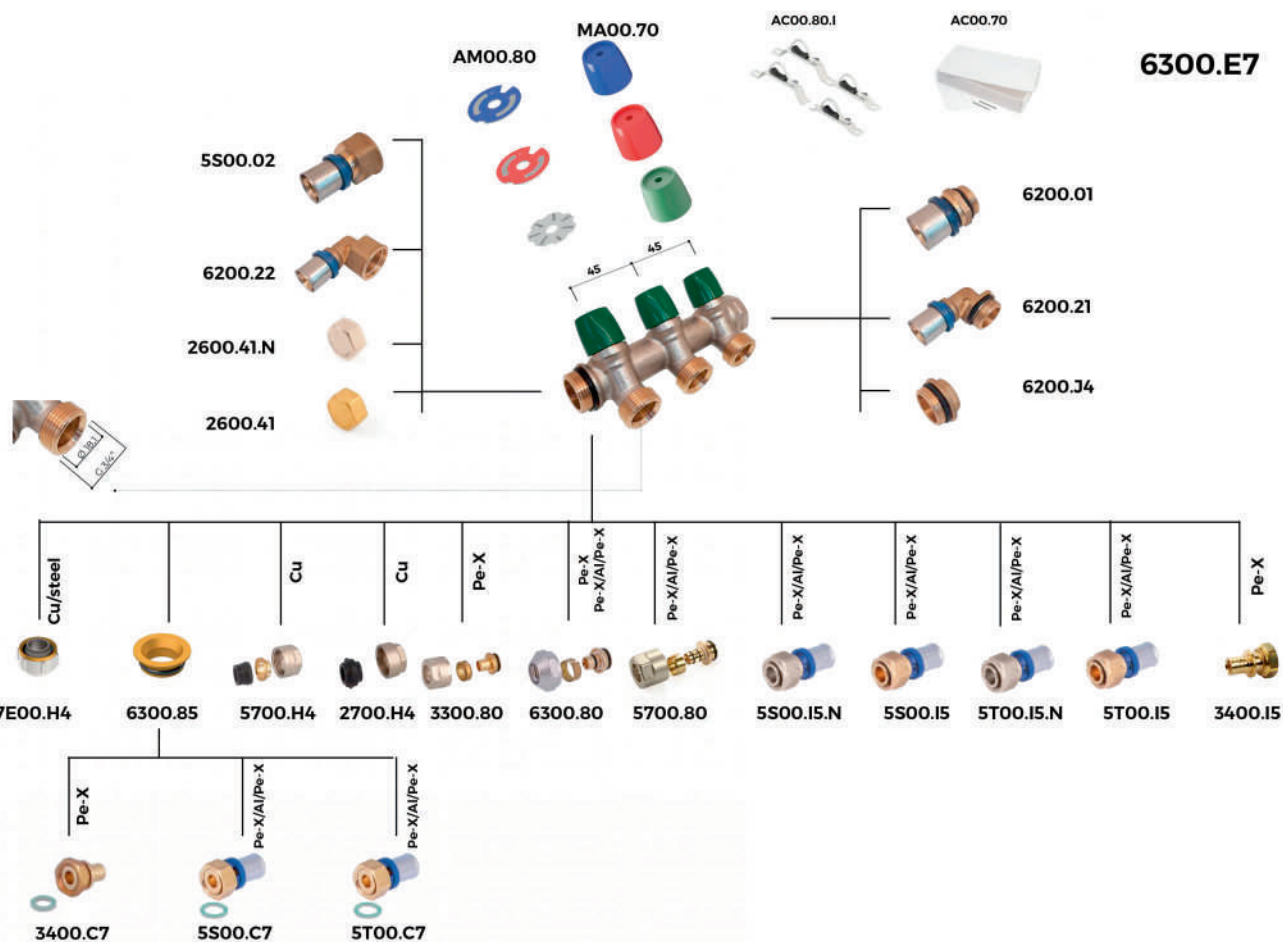

INSERTI E RACCORDI INSERTS AND FITTINGS		
CODICE CODE	DESCRIZIONE DESCRIPTION	TUBO PIPE
AM00.80	Dischetto utenze Destination label	
MA00.70	Manopola Knob	
AC00.80.I	Staffa Per collettori Flexus Bracket for Flexus manifolds	
AC00.70	Cassetta collettore Manifold cabinet	
7E00.H4	Kit eurocono Eurocone adapter	tubo rame e tubo acciaio copper and steel pipe
6300.85	Adattatore sede piana Flat seal adapter	
5700.H4	Dado nichelato con ogiva e guarnizione Nickel plated nut with assembled ring and gasket	tubo rame copper pipe
2700.H4	Dado nichelato con ogiva e guarnizione Nickel plated nut with assembled ring and gasket	tubo rame copper pipe
3300.80	Dado nichelato con ogiva e inserto eurocono Nickel plated nut, olive and insert eurocone	tubo Pe-X Pe-X pipe
5700.80	Dado nichelato con ogiva e inserto eurocono Nickel plated nut, olive and insert eurocone	tubo multistrato multilayer pipe

6300.80	Dado nichelato con ogiva e inserto eurocono Nickel plated nut, olive and insert eurocone	tubo multistrato, tubo Pe-X (solo per Ø17) multilayer pipe, Pe-X pipe (only for Ø17)
5500.I5	Raccordo dritto sede conica O-Ring con girello- Straight fitting with loose nut and conical connection	tubo multistrato multilayer pipe
5500.I5.N	Raccordo dritto nichelato sede conica O-Ring con girello- Nickel plated straight fitting with loose nut and conical connection	tubo multistrato multilayer pipe
5T00.I5	Raccordo dritto sede conica O-Ring con girello- Straight fitting with loose nut and conical connection	tubo multistrato multilayer pipe
5T00.I5.N	Raccordo dritto nichelato sede conica O-Ring con girello- Nickel plated straight fitting with loose nut and conical connection	tubo multistrato multilayer pipe
3400.I5	Raccordo dritto eurocono con girello Straight fitting with loose nut and eurocone connection	tubo Pe-X Pe-X pipe
3400.C7	Raccordo dritto sede piana con girello con guarnizione Straight fitting with loose nut and flat washer	tubo Pe-X Pe-X pipe
5500.C7	Raccordo dritto sede piana con girello con guarnizione Straight fitting with loose nut and flat washer	tubo multistrato multilayer pipe
5T00.C7	Raccordo dritto sede piana con girello con guarnizione Straight fitting with loose nut and flat washer	tubo multistrato multilayer pipe
6200.01	Raccordo dritto maschio con O-Ring Male straight fitting with O-Ring	
6200.21	Angolo maschio fasato con O-Ring Self-seal male elbow with O-Ring	
5500.02	Raccordo dritto femmina Female straight fitting	
6200.22	Angolo femmina fasato con O-Ring Self-seal female elbow with O-Ring	
2600.41/41.N	Tappo femmina / tappo femmina nichelato Female cap / Nickel plated female cap	
6200.J4	Tappo maschio con O-Ring Male cap with O-Ring	

CERTIFICAZIONI CERTIFICATIONS

STATO COUNTRY	CERTIFICAZIONE CERTIFICATION	STATO COUNTRY	CERTIFICAZIONE CERTIFICATION	STATO COUNTRY	CERTIFICAZIONE CERTIFICATION
					
					
					

NORMATIVE

- UNI EN ISO 228-1
Filettatura di tubazioni per accoppiamento non a tenuta
sul filetto

REGULATIONS

- UNI EN ISO 228-1:2003
Threads complies with UNI EN ISO 228-1:2003 law: "Piping
thread for coupling not with tightness on the thread"

- UNI EN 13828 (solo versione con minivalvole 6200.R6)
Rubinetti a sfera di leghe di rame e acciaio inossidabile a comando manuale per l'approvvigionamento di acqua potabile negli edifici
- D.M. 174 (06/04/2004)

I materiali utilizzati sono conformi al Decreto Ministeriale n° 174 del 06/04/2004 [Regolamento concernente i materiali e gli oggetti che possono essere utilizzati negli impianti fissi di captazione, trattamento, adduzione e distribuzione delle acque destinate al consumo umano]

- EN ISO 1254 parte 2,3,4

Conforme alla norma EN ISO 1254, parte 2,3,4: "Rame e leghe di rame - Raccorderia idraulica"

- Conforme a 4MS, UBA List (gruppo BC), DIN 50930/6 Dir. 2011/65/UE, 6C allegato III (RhOSII)

- UNI EN 13828 (only for 6200.R6)

"Ball valves of copper alloys and stainless steel hand operated, for the supply of drinking water in buildings".

- D.M. 174 (06/04/2004)

Raw materials used are of high quality and comply with the Ministerial Decree N°174 dated 06/04/2004 concerning the materials and the items used in fixed installations for water collection, treatment and supply.

- EN ISO 1254 part 2,3,4

Copper and copper alloys - Plumbing fittings

- Comply with 4MS, UBA List (BC group), DIN 50930/6 Dir. 2011/65/UE, 6C attachment III (RhOSII).

ISTRUZIONI DI MONTAGGIO ASSEMBLY INSTRUCTIONS

I collettori FLEXUS possono essere montati nell'apposita cassetta, codice AC00.70, che include il kit di fissaggio

FLEXUS manifolds can be assembled in AC00.70 cabinet which includes fixing kit.



CODICE CODE	MISURA SIZE
AC0070H203295H	260x320x95
AC0070H204095H	260x400x95
AC0070H205095H	260x500x95

DIMENSIONI 6200.E7
DIMENSIONS 6200.E7

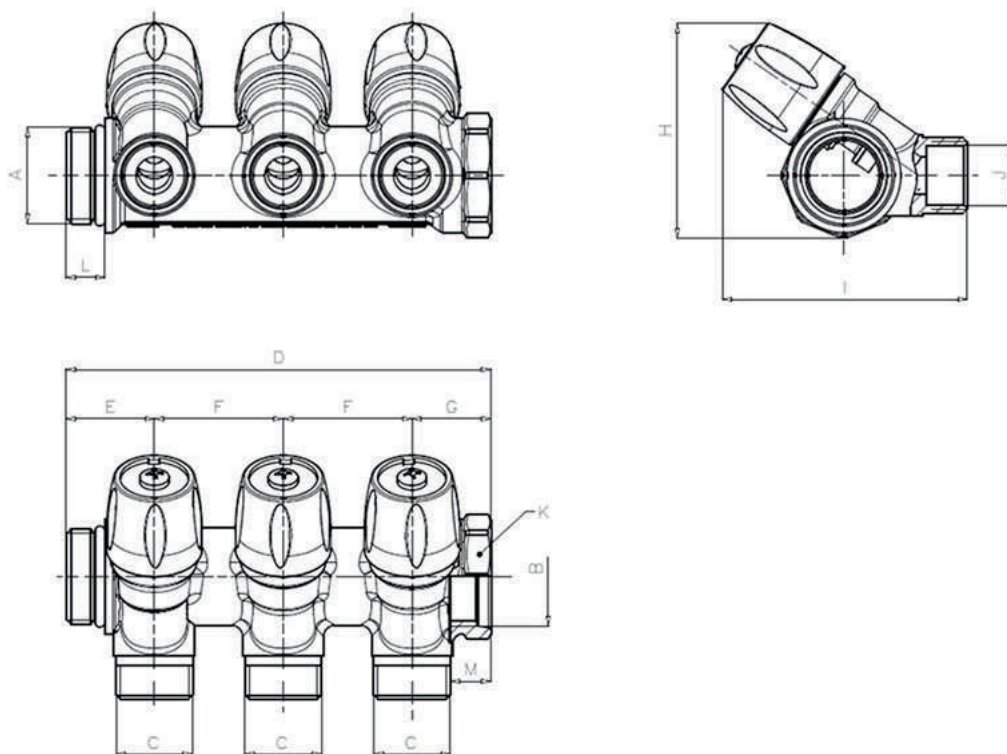

CODICE CODE	A	B	C	D	E	F	G	H	I	K	J	L
6200E7N0504W2A 6200E7N0504B2A 6200E7N0504R2A	G 3/4"		G 1/2"	80.5	24	35	21.5	58	66	32	Ø16,25	10.5
6200E7N0504W3A 6200E7N0504B3A 6200E7N0504R3A	G 3/4"		G 1/2"	115.5	24	35	21.5	58	66	32	Ø16,25	10.5
6200E7N0504W4A 6200E7N0504B4A 6200E7N0504R4A	G 3/4"		G 1/2"	150.5	24	35	21.5	58	66	32	Ø16,25	10.5
6200E7N1004W2A 6200E7N1004B2A 6200E7N1004R2A	G 1"		G 1/2"	92	28	35	29	62	68	38	Ø16,25	12
6200E7N1004W3A 6200E7N1004B3A 6200E7N1004R3A	G 1"		G 1/2"	127	28	35	29	62	68	38	Ø16,25	12
6200E7N1004W4A 6200E7N1004B3A 6200E7N1004R3A	G 1"		G 1/2"	162	28	35	29	62	68	38	Ø16,25	12

DIMENSIONI 6200.R6
DIMENSIONS 6200.R6

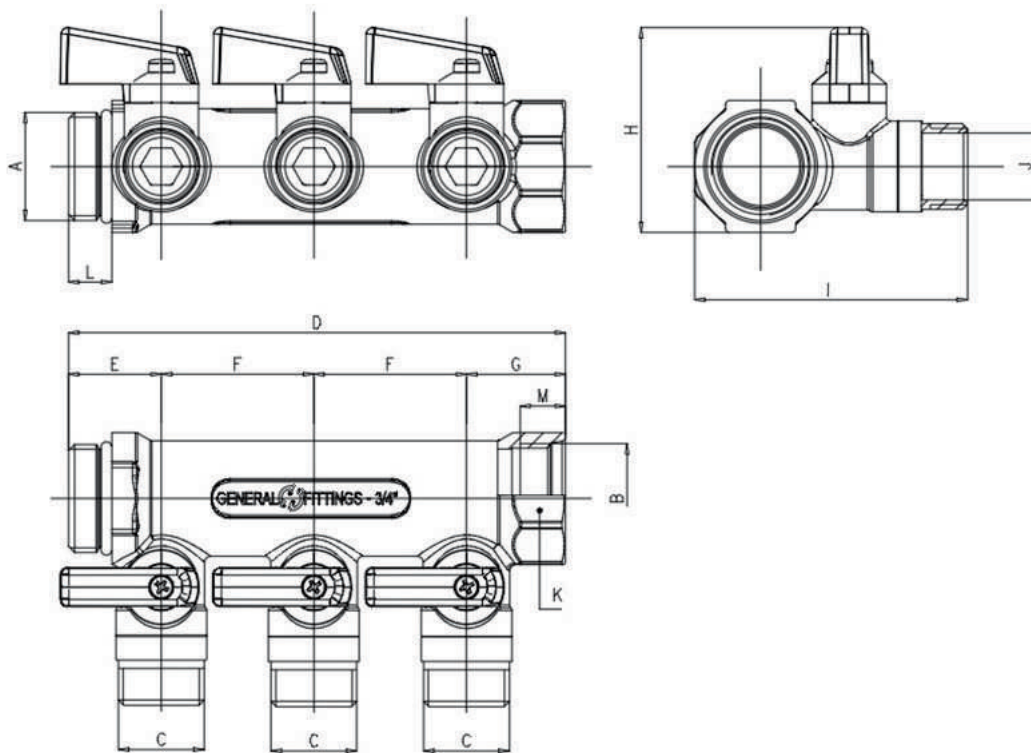

CODICE CODE	A	B	C	D	E	F	G	H	I	K	J	L
6200R6H0504B2A 6200R6H0504R2A	G 3/4"		G 1/2"	83.5	22.5	37	24	49.7	66.5	32	Ø16,25	10.5
6200R6H0504B3A 6200R6H0504R3A	G 3/4"		G 1/2"	157.5	22.5	37	24	49.7	66.5	32	Ø16,25	10.5
6200R6H0504B4A 6200R6H0504R4A	G 3/4"		G 1/2"	120.5	22.5	37	24	49.7	66.5	32	Ø16,25	10.5
6200R6H1004B2A 6200R6H1004R2A	G 1"		G 1/2"	87	24	37	26	52.7	72.5	38	Ø16,25	12
6200R6H1004B3A 6200R6H1004R3A	G 1"		G 1/2"	87	24	37	26	52.7	72.5	38	Ø16,25	12

DIMENSIONI 6300.E7
DIMENSIONI 6300.E7

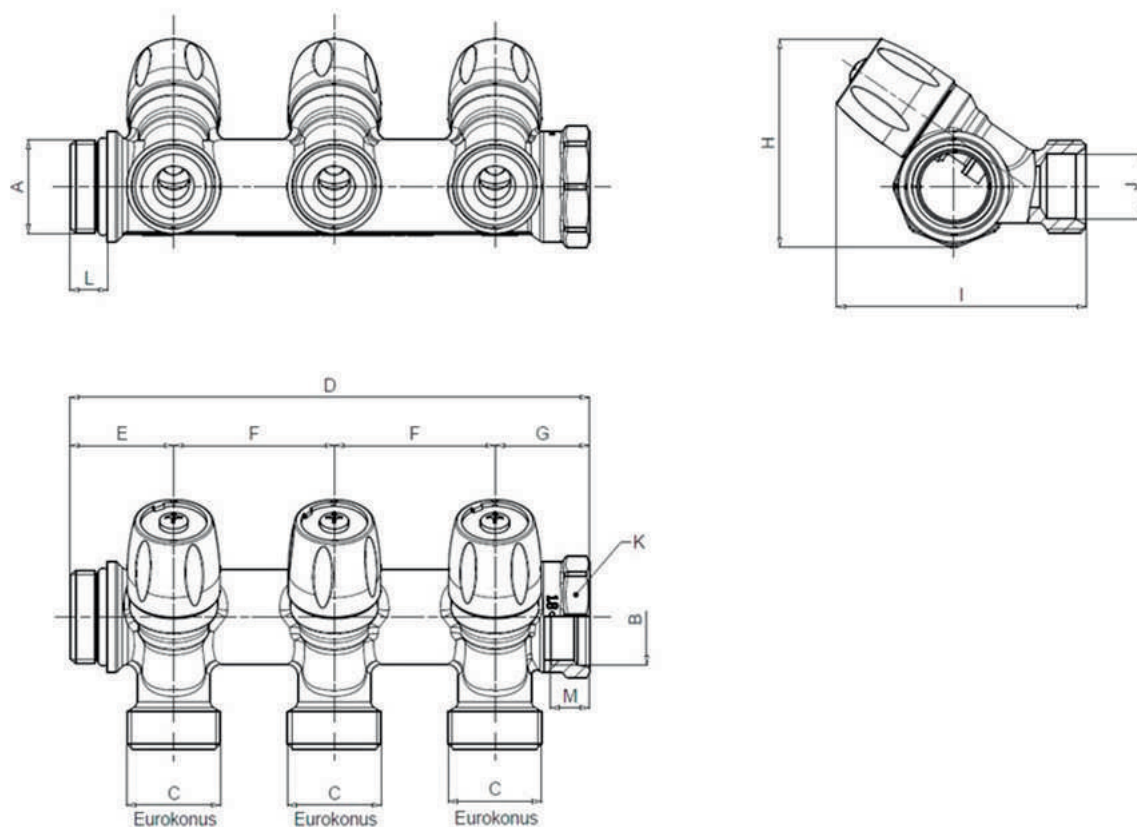

CODICE CODE	A	B	C	D	E	F	G	H	I	K	J	L
6300E7N0505V2A 6300E7N0505R2A 6300E7N0505B2A	G 3/4"		3/4" Ek.	100.5	29	45	26.5	58	70	32	Ø18,1	10.5
6300E7N0505V3A 6300E7N0505R3A 6300E7N0505B3A	G 3/4"		3/4" Ek.	145.5	29	45	26.5	58	70	32	Ø18,1	10.5
6300E7N0505V4A 6300E7N0505R4A 6300E7N0505B4A	G 3/4"		3/4" Ek.	190.5	29	45	26.5	58	70	32	Ø18,1	10.5
6300E7N1005V2A 6300E7N1005R2A 6300E7N1005B2A	G 1"		3/4" Ek.	102	28	45	29	62	70	38	Ø18,1	13
6300E7N1005V3A 6300E7N1005R3A 6300E7N1005B3A	G 1"		3/4" Ek.	147	28	45	29	62	70	38	Ø18,1	13
6300E7N1005V4A 6300E7N1005R4A 6300E7N1005B4A	G 1"		3/4" Ek.	192	28	45	29	62	70	38	Ø18,1	13

6200.E7 COLLETTORE FASATO CON VITONI BIANCHI E DISCHETTO UTENZE
 SELF-SEAL THREAD MANIFOLD WITH WHITE HEAD SCREWS AND DESTINATION LABELS



CODICE				
6200E7N0504W2A	3/4"	2	1/2"	25
6200E7N0504W3A	3/4"	3	1/2"	15
6200E7N0504W4A	3/4"	4	1/2"	10
6200E7N1004W2A	1"	2	1/2"	20
6200E7N1004W3A	1"	3	1/2"	10
6200E7N1004W4A	1"	4	1/2"	10

6200.E7 BLU COLLETTORE FASATO CON VITONI BLU
 SELF-SEAL THREAD MANIFOLD WITH BLUE HEAD SCREWS



CODICE				
6200E7N0504B2A	3/4"	2	1/2"	20
6200E7N0504B3A	3/4"	3	1/2"	15
6200E7N0504B4A	3/4"	4	1/2"	10
6200E7N1004B2A	1"	2	1/2"	20
6200E7N1004B3A	1"	3	1/2"	10
6200E7N1004B4A	1"	4	1/2"	10

6200.E7 ROSSO COLLETTORE FASATO CON VITONI ROSSI
 SELF-SEAL THREAD MANIFOLD WITH RED HEAD SCREWS



CODICE				
6200E7N0504R2A	3/4"	2	1/2"	20
6200E7N0504R3A	3/4"	3	1/2"	15
6200E7N0504R4A	3/4"	4	1/2"	10
6200E7N1004R2A	1"	2	1/2"	20
6200E7N1004R3A	1"	3	1/2"	10
6200E7N1004R4A	1"	4	1/2"	10

6200.R6 BLU COLLETTORE FASATO CON MINI VALVOLA E LEVETTE BLU
 SELF-SEAL THREAD MANIFOLD WITH MINI VALVE AND BLUE HANDLES



CODICE				
6200R6H0504B2A	3/4"	2	1/2"	20
6200R6H0504B3A	3/4"	3	1/2"	15
6200R6H0504B4A	3/4"	4	1/2"	10
6200R6H1004B2A	1"	2	1/2"	15
6200R6H1004B3A	1"	3	1/2"	10

**6200.R6.N
BLU**

COLLETTORE FASATO NICHELATO CON MINI VALVOLA E LEVETTE BLU
NICKEL PLATED SELF-SEAL THREAD MANIFOLD WITH MINI VALVE AND BLUE HANDLES



CODICE				
6200R6N0504B2A	3/4"	2	1/2"	20
6200R6N0504B3A	3/4"	3	1/2"	15
6200R6N0504B4A	3/4"	4	1/2"	10
6200R6N1004B2A	1"	2	1/2"	15
6200R6N1004B3A	1"	3	1/2"	10

Disponibile a richiesta

Available on demand

**6200.R6
ROSSO**

COLLETTORE CON MINI VALVOLA E LEVETTE ROSSE
SELF-SEAL THREAD MANIFOLD WITH MINI VALVE AND RED HANDLES



CODICE				
6200R6H0504R2A	3/4"	2	1/2"	20
6200R6H0504R3A	3/4"	3	1/2"	15
6200R6H0504R4A	3/4"	4	1/2"	10
6200R6H1004R2A	1"	2	1/2"	15
6200R6H1004R3A	1"	3	1/2"	10

**6200.R6.N
ROSSO**

COLLETTORE FASATO NICHELATO CON MINI VALVOLA E LEVETTE ROSSE
NICKEL PLATED SELF-SEAL THREAD MANIFOLD WITH MINI VALVE AND RED HANDLES



CODICE				
6200R6N0504R2A	3/4"	2	1/2"	20
6200R6N0504R3A	3/4"	3	1/2"	15
6200R6N0504R4A	3/4"	4	1/2"	10
6200R6N1004R2A	1"	2	1/2"	15
6200R6N1004R3A	1"	3	1/2"	10

Disponibile a richiesta

Available on demand

3300.R6 BLU COLLETTORE FASATO CON MINI VALVOLE E USCITE A COMPRESSIONE PER TUBO PE-X
 MANIFOLD WITH MINI-VALVES WITH COMPRESSION EXITS FOR PE-X PIPE



CODICE	+	⊣	⋈	∅	📦
3300R6H0552B2A	2.5	3/4"	2	15	20
3300R6H0552B3A	2.5	3/4"	3	15	15
3300R6H0552B4A	2.5	3/4"	4	15	10
3300R6H0556B2A	2.0	3/4"	2	16	20
3300R6H0556B3A	2.0	3/4"	3	16	15
3300R6H0556B4A	2.0	3/4"	4	16	10
3300R6H0558B2A	2.2	3/4"	2	16	20
3300R6H0558B3A	2.2	3/4"	3	16	15
3300R6H0558B4A	2.2	3/4"	4	16	10
3300R6H1058B2A	2.2	1"	2	16	20
3300R6H1058B3A	2.2	1"	3	16	15

3300.R6 ROSSO COLLETTORE FASATO CON MINI VALVOLE E USCITE A COMPRESSIONE PER TUBO PE-X
 MANIFOLD WITH MINI-VALVES WITH COMPRESSION EXITS FOR PE-X PIPE



CODICE	+	⊣	⋈	∅	📦
3300R6H0552R2A	2.5	3/4"	2	15	20
3300R6H0552R3A	2.5	3/4"	3	15	15
3300R6H0552R4A	2.5	3/4"	4	15	10
3300R6H0556R2A	2.0	3/4"	2	16	20
3300R6H0556R3A	2.0	3/4"	3	16	15
3300R6H0556R4A	2.0	3/4"	4	16	10
3300R6H0558R3A	2.2	3/4"	3	16	15
3300R6H0558R2A	2.2	3/4"	2	16	20
3300R6H0558R4A	2.2	3/4"	4	16	10
3300R6H1058R2A	2.2	1"	2	16	20
3300R6H1058R3A	2.2	1"	3	16	15

6300.E7 COLLETTORE FASATO CON VITONI E DISCHETTO UTENZE
 SELF-SEAL THREAD MANIFOLD WITH HEAD SCREWS AND DESTINATION LABELS



CODICE	⊣	⋈	■	📦
6300E7N0505V2A	3/4"	2	3/4" EK.	15
6300E7N0505V3A	3/4"	3	3/4" EK.	10
6300E7N0505V4A	3/4"	4	3/4" EK.	6
6300E7N1005V2A	1"	2	3/4" EK.	10
6300E7N1005V3A	1"	3	3/4" EK.	10
6300E7N1005V4A	1"	4	3/4" EK.	6

**6300.E7
ROSSO**

COLLETORE FASATO CON VITONI ROSSI
SELF-SEAL THREAD MANIFOLD WITH RED HEAD
SCREWS



CODICE				
6300E7N0505R2A	3/4"	2	3/4" EK.	15
6300E7N0505R3A	3/4"	3	3/4" EK.	10
6300E7N0505R4A	3/4"	4	3/4" EK.	6
6300E7N1005R2A	1"	2	3/4" EK.	10
6300E7N1005R3A	1"	3	3/4" EK.	10
6300E7N1005R4A	1"	4	3/4" EK.	6

6300.E7 BLU

COLLETORE FASATO CON VITONI BLU
SELF-SEAL THREAD MANIFOLD WITH BLUE HEAD
SCREWS



CODICE				
6300E7N0505B2A	3/4"	2	3/4" EK.	15
6300E7N0505B3A	3/4"	3	3/4" EK.	10
6300E7N0505B4A	3/4"	4	3/4" EK.	6
6300E7N1005B2A	1"	2	3/4" EK.	10
6300E7N1005B3A	1"	3	3/4" EK.	10
6300E7N1005B4A	1"	4	3/4" EK.	6

MA00.70

MANOPOLA
HANDLE



CODICE	i
MA0070B262400H	Blu
MA0070R262400H	Rossa
MA0070W262400H	Bianca-6200.E7
MA0070V262400H	Verde - 6300.E7

AM00.80

DISCHETTO UTENZE
DESTINATION LABEL



CODICE	i
AM0080H184500H	Blu/Rosso
AM0080H1845E1H	Utenze

MA00.80 LEVETTA COLLETTORE
MANIFOLD HANDLE



CODICE	i
MA0080B183300A	BLU
MA0080R183300A	ROSSO

6200.01 RACCORDO DIRITTO MASCHIO CON O-RING
MALE STRAIGHT FITTING WITH O-RING



CODICE	+	Ø	◇	☐
620001H052020A	2.0	3/4"x20	10	80
620001H052025A	2.5	3/4"x20	-	-
620001H052630A	3.0	3/4"x26	5	50
620001H102630A	3.0	1"x26	5	40
620001H103230A	3.0	1"x32	5	40

6200.21 ANGOLO MASCHIO FASATO CON O-RING
SELF-SEAL MALE ELBOW WITH O-RING



CODICE	+	Ø	◇	☐
620021H052020A	2.0	3/4"x20	10	60
620021H052025A	2.5	3/4"x20	10	60
620021H052630A	3.0	3/4"x26	5	50
620021H102630A	3.0	1"x26	5	25
620021H103230A	3.0	1"x32	5	20

6200.22 ANGOLO FEMMINA FASATO
SELF-SEAL FEMALE ELBOW WITH O-RING



CODICE	+	Ø	◇	☐
620022H052020A	2.0	3/4"x20	10	50
620022H052025A	2.5	3/4"x20	10	50
620022H052630A	3.0	3/4"x26	5	30
620022H102630A	3.0	1"x26	5	25
620022H103230A	3.0	1"x32	5	25

5S00.02 RACCORDO DIRITTO FEMMINA
FEMALE STRAIGHT FITTING



CODICE	+	Ø	◇	☐
5S0002H052020T	2.0	3/4"x20	10	50
5S0002H052022T	2.25	3/4"x20	10	50
5S0002H102630T	3.0	1"x26	5	40
5S0002H103230T	3.0	1"x32	5	30

6200.J4 TAPPO MASCHIO CON O-RING
MALE CAP WITH O-RING



CODICE	Ø	◇	☐
6200J4H050000A	3/4"	10	200
6200J4H100000A	1"	10	100

2600.41 TAPPO FEMMINA
FEMALE CAP



CODICE	Ø	◇	☐
260041H040000A	1/2"	10	350
260041H050000A	3/4"	10	200
260041H100000A	1"	10	100

2600.41.N TAPPO FEMMINA NICHELATO
NICKEL-PLATED FEMALE CAP



CODICE	Ø	◇	☐
260041N040000A	1/2"	10	350
260041N050000A	3/4"	10	200
260041N100000A	1"	10	100



FLEXUS 90°



Collettori di distribuzione fasati con O-ring Self-aligned manifolds with O-Ring

I collettori FLEXUS 90° sono una soluzione semplice ed essenziale per un'efficace distribuzione sanitaria. La fasatura dei filetti e la presenza dell'O-Ring consentono di assemblare più collettori senza l'ausilio di alcun sigillante, garantendo sempre l'allineamento delle uscite. Sono utilizzabili per la realizzazione di impianti di riscaldamento, raffrescamento e sanitari. La configurazione dei collettori consente la realizzazione di circuiti caldi e/o freddi in parallelo.

FLEXUS 90° manifolds are suitable for heating and sanitary water distribution. Self-aligning and the O-Ring grant the aligning of the coupled manifolds without using any additional means, such as teflon tape or hemp. Flexus manifolds are suitable for sanitary, heating and cooling installations. Their configuration allows the realization of hot and/or cold circuits in parallel.



VANTAGGI

- Fasatura filetti: composizione allineata
- Garanzia di tenuta senza sigillanti grazie all'O-Ring: rapidità d'installazione
- Non serve utilizzare la canapa o altri sigillanti
- Doppia tenuta O-Ring che garantisce una maggiore tenuta idraulica
- Grazie al vitone realizzato in 3 componenti di ottone, la manopola in fase di manovra si muove sull'asse di rotazione senza variare la propria posizione in altezza rispetto al collettore
- Corpo realizzato per "gravity" casting
- Disponibili con vitoni completi di dischetti utenze, con attacchi 3/4" o 1" ed uscite 1/2", 3/4"EK, 24x19
- Materie prime impiegate di alta qualità [UBA LIST]
- Adatti a tutte le tipologie di tubo plastico, metallo e metallo-plastico
- La posizione frontale della manopola consente un facile accesso ed una buona comodità di manovra
- Riduzione degli ingombri
- Interasse costante 45mm
- Idoneità al contatto con acqua potabile

ADVANTAGES

- *Self-aligning granting the correct and quick aligning of the coupled manifolds*
- *Perfectly tight: thanks to the O-Ring the coupling is tight without using any additional means, such as Teflon tape or hemp, for a faster installation*
- *No need to use hemp or other sealants*
- *Double O-ring seal for improved tightness*
- *Thanks to the screw made of 3 brass components, the knob moves on its axis of rotation without changing its height position in relation to the manifold*
- *"Gravity casting" body*
- *Available with valves (with destination labels), with 3/4" or 1" inlet and 1/2", 3/4"EK, 24x19 outlets*
- *Raw materials complying with UBA LIST*
- *Suitable for plastic, metal and metal-plastic pipes*
- *The front position of the knob allows easy access and good maneuvering convenience*
- *Encumbrances reduction*
- *Constant center distance 45 mm*
- *Suitable for drinking water*

CAMPI DI APPLICAZIONI E PRESTAZIONI FIELDS OF APPLICATION

APPLICAZIONI APPLICATIONS		T. min.	T. max	T.di sistema T.of the system	Press.max Max. pressure
	acqua calda sanitari hot sanitary water	-20°C	+120°C	-20°C +95°C	10 bar
	raffrescamento cooling	-20°C	+120°C	-20°C +95°C	10 bar
	radiatori radiators	-20°C	+120°C	-20°C +95°C	10 bar
-20°C: solo con liquido antigelo, glicole, in % max del 30% -20°C: only with antifreeze liquid (glycol) in % max of 30%					

DISCHETTI UTENZE DESTINATION LABELS

I collettori Flexus 90° vengono forniti con appositi dischetti utenze identificative dell'utilizzo acqua calda/fredda (rosso-blu) e della zona di utilizzo.

Flexus 90° manifolds are supplied with hot/cold water (red/blue) and zone of use identification labels.



DOPPIA TENUTA O-RING DOUBLE O-RING SEAL

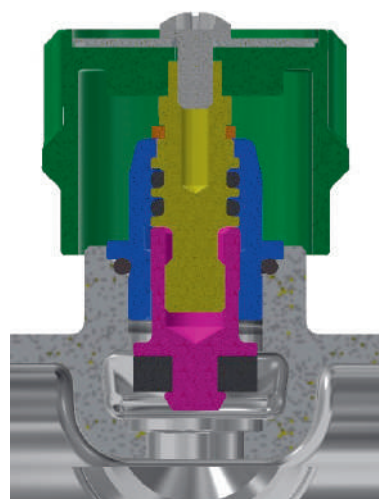

I collettori FLEXUS 90° sono caratterizzati dalla presenza di una doppia tenuta O-Ring sull'asta di manovra che garantisce una maggiore tenuta idraulica, un'ulteriore O-Ring a garanzia di tenuta tra il vitone ed il corpo del collettore ed una guarnizione piatta che consente, una volta avvitata la manopola in chiusura, di intercettare il fluido.

FLEXUS 90° manifolds are characterised by the presence of a double O-Ring seal on the manoeuvring rod that guarantees a greater hydraulic seal, an additional O-Ring to guarantee a seal between the screw and the manifold body, and a flat gasket that allows the fluid to be intercepted once the knob has been screwed shut.



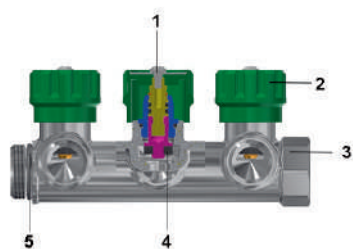



COMPONENTI E MATERIALI COMPONENTS AND MATERIALS

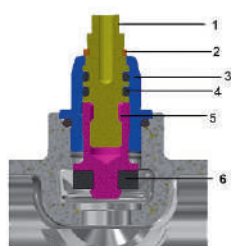

LEGENDA LEGEND	COMPONENTI COMPONENTS	MATERIALI MATERIALS
	1 Vite Screw	Acciaio CB4F Steel CB4F
	2 Manopola Knob	ABS
	3 Corpo Body	CB753S-UNI EN 1982:2000
	5 O-Ring per fasatura Self-seal O-Ring	Elastomero per acqua potabile Elastomer for drinking water
	4 Guarnizione piatta Flat gasket	Elastomero per acqua potabile Elastomer for drinking water

COMPONENTI E MATERIALI VITONE (6200.R8-6300.R8-6400.R8-6200.RP) 6200.R8-6300.R8-6400.R8-6200.RP: SCREW COMPONENTS AND MATERIALS



LEGENDA LEGEND	COMPONENTI COMPONENTS	MATERIALI MATERIALS
	1 Asta superiore Top stem	CW617N - UNI EN 12164 Brass CW617N - UNI EN 12164
	2 Forcella di fermo Stop fork	Bronzo fosforoso Phosphor bronze
	3 Corpo Vitone Body	CW617N - UNI EN 12164 Brass CW617N - UNI EN 12164
	4 O-Ring	Elastomero per acqua potabile Elastomer for drinking water
	5 Asta inferiore Bottom stem	CW617N - UNI EN 12164 Brass CW617N - UNI EN 12164
	6 Guarnizione piatta Flat gasket	Elastomero per acqua potabile Elastomer for drinking water

GUIDA ALLE CONNESSIONI 6200.R8

6200.R8: CONNECTION GUIDE

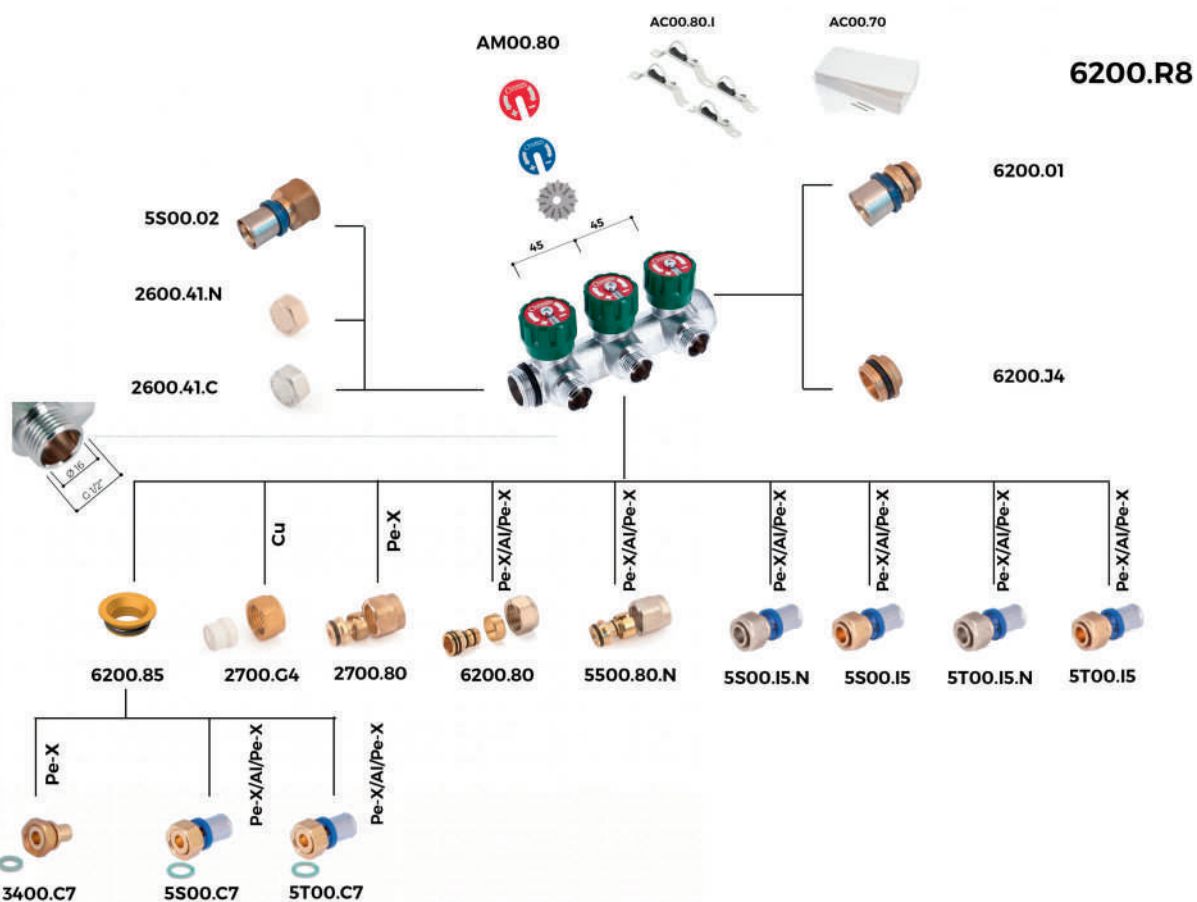

INSERTI E RACCORDI INSERTS AND FITTINGS

CODICE CODE	DESCRIZIONE DESCRIPTION	TUBO PIPE
AM00.80	Dischetto utenze Destination label	
AC00.80.I	Staffa Per collettori Flexus Bracket for Flexus manifolds	
AC00.70	Cassetta collettore Manifold cabinet	
6200.85	Adattatore sede piana Flat seal adapter	
2700.G4	Dado e monocono P.T.F.E Nut and monocone P.T.F.E	tubo rame copper pipe
2700.80	Dado, ogiva e inserto Nut, olive and insert	tubo Pe-X Pe-X pipe
6200.80	Dado nichelato, ogiva ed inserto Nickel-plated nut, olive and insert	tubo multistrato multilayer pipe
5500.80.N	Dado nichelato, ogiva ed inserto Nickel-plated nut, olive and insert	tubo multistrato multilayer pipe
5500.I5	Raccordo dritto sede conica O-Ring con girello- Straight fitting with loose nut and conical connection	tubo multistrato multilayer pipe
5T00.I5	Raccordo dritto sede conica O-Ring con girello- Straight fitting with loose nut and conical connection	tubo multistrato multilayer pipe

INSERTI E RACCORDI
INSERTS AND FITTINGS

5500.I5.N	Raccordo dritto nichelato sede conica O-Ring con girello- Nickel plated straight fitting with loose nut and conical connection	tubo multistrato multilayer pipe
5T00.I5.N	Raccordo dritto nichelato sede conica O-Ring con girello- Nickel plated straight fitting with loose nut and conical connection	tubo multistrato multilayer pipe
3400.C7	Raccordo diritto sede piana con girello con guarnizione Straight fitting with loose nut and flat washer	tubo Pe-X Pe-X pipe
5500.C7	Raccordo diritto sede piana con girello con guarnizione Straight fitting with loose nut and flat washer	tubo multistrato multilayer pipe
5T00.C7	Raccordo diritto sede piana con girello con guarnizione Straight fitting with loose nut and flat washer	tubo multistrato multilayer pipe
6200.01	Raccordo dritto maschio con O-Ring Male straight fitting with O-Ring	
5500.02	Raccordo diritto femmina Female straight fitting	
2600.41.C	Tappo femmina cromato	
2600.41.N	Tappo femmina nichelato	
6200.J4	Tappo maschio con O-Ring Male cap with O-Ring	

GUIDA ALLE CONNESSIONI 6200.RP 6200.RP: CONNECTION GUIDE

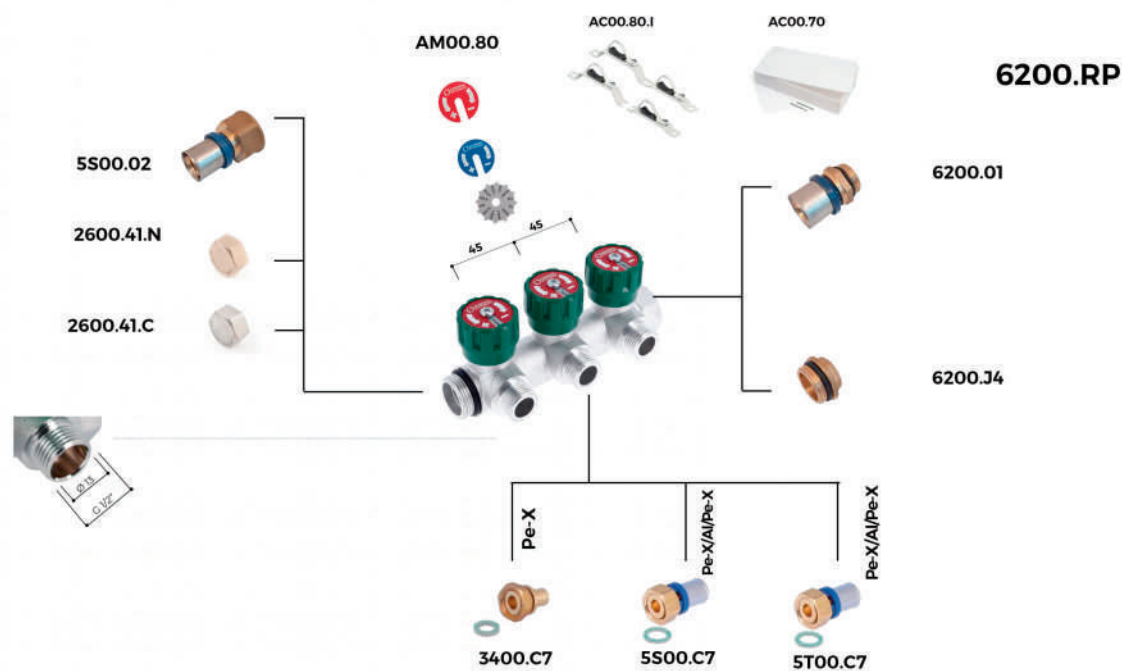

INSERTI E RACCORDI INSERTS AND FITTINGS

CODICE CODE	DESCRIZIONE DESCRIPTION	TUBO PIPE
AM00.80	Dischetto utenze Destination label	
AC00.80.I	Staffa Per collettori Flexus Bracket for Flexus manifolds	
AC00.70	Cassetta collettore Manifold cabinet	
6200.01	Raccordo dritto maschio con O-Ring Male straight fitting with O-Ring	
5500.02	Raccordo dritto femmina Female straight fitting	
2600.41.C	Tappo femmina cromato	
2600.41.N	Tappo femmina nichelato	
6200.J4	Tappo maschio con O-Ring Male cap with O-Ring	
3400.C7	Raccordo dritto sede piana con girello con guarnizione Straight fitting with loose nut and flat washer	tubo Pe-X Pe-X pipe
5500.C7	Raccordo dritto sede piana con girello con guarnizione Straight fitting with loose nut and flat washer	tubo multistrato multilayer pipe
5T00.C7	Raccordo dritto sede piana con girello con guarnizione Straight fitting with loose nut and flat washer	tubo multistrato multilayer pipe

GUIDA ALLE CONNESSIONI 6300.R8

6300.R8: CONNECTION GUIDE

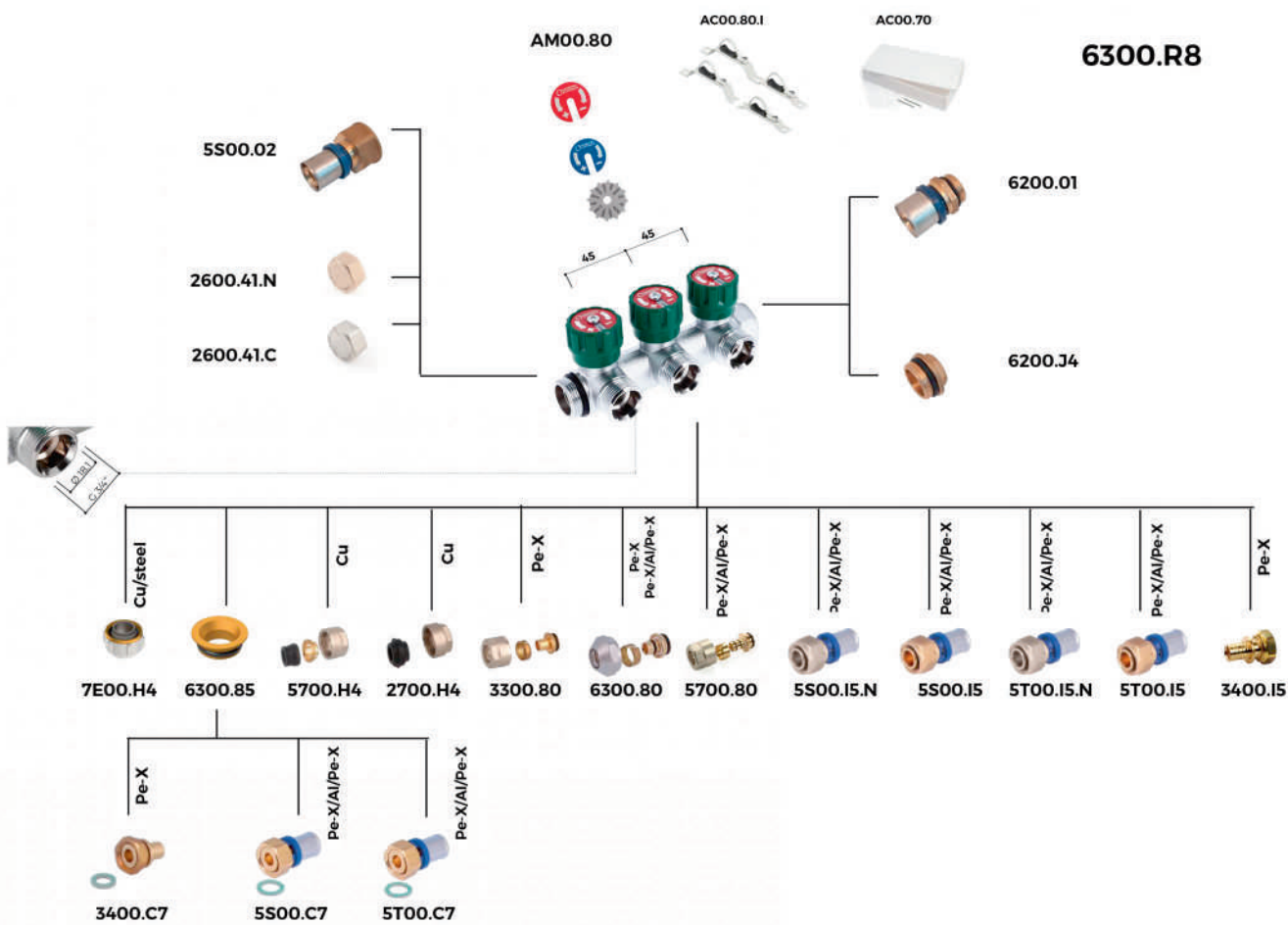

INSERTI E RACCORDI INSERTS AND FITTINGS

CODICE CODE	DESCRIZIONE DESCRIPTION	TUBO PIPE
AM00.80	Dischetto utenze Destination label	
AC00.80.I	Staffa Per collettori Flexus Bracket for Flexus manifolds	
AC00.70	Cassetta collettore Manifold cabinet	
7E00.H4	Kit eurocono Eurocone kit	tubo rame e tubo acciaio copper and steel pipe
6300.85	Adattatore sede piana Flat seal adapter	tubo Pe-X 5500.C7: tubo multistrato Pe-X pipe 5500.C7: tubo multistrato
5700.H4	Dado nichelato con ogiva e guarnizione Nickel plated nut with assembled ring and gasket	tubo rame copper pipe
2700.H4	Dado nichelato con ogiva e guarnizione Nickel plated nut with assembled ring and gasket	tubo rame copper pipe
3300.80	Dado nichelato con ogiva e inserto eurocono Nickel plated nut, olive and insert eurocone	tubo Pe-X Pe-X pipe
5700.80	Dado nichelato con ogiva e inserto eurocono Nickel plated nut, olive and insert eurocone	tubo multistrato multilayer pipe
6300.80	Dado nichelato con ogiva e inserto eurocono Nickel plated nut, olive and insert eurocone	tubo multistrato, tubo Pe-X (solo per Ø17) multilayer pipe, Pe-X pipe (only for Ø17)

5S/5T00.I500.I5	Raccordo dritto sede conica O-Ring con girello- Straight fitting with loose nut and conical connection	tubo multistrato multilayer pipe
3400.I5	Raccordo dritto sede conica O-Ring con girello- Straight fitting with loose nut and conical connection	tubo Pe-X Pe-X pipe
5500.I5.N	Raccordo dritto nichelato sede conica O-Ring con girello- Nickel plated straight fitting with loose nut and conical connection	tubo multistrato multilayer pipe
5T00.I5.N	Raccordo dritto nichelato sede conica O-Ring con girello- Nickel plated straight fitting with loose nut and conical connection	tubo multistrato multilayer pipe
3400.C7	Raccordo dritto sede piana con girello con guarnizione Straight fitting with loose nut and flat washer	tubo Pe-X Pe-X pipe
5500.C7	Raccordo dritto sede piana con girello con guarnizione Straight fitting with loose nut and flat washer	tubo multistrato multilayer pipe
5T00.C7	Raccordo dritto sede piana con girello con guarnizione Straight fitting with loose nut and flat washer	tubo multistrato multilayer pipe
6200.01	Raccordo dritto maschio con O-Ring Male straight fitting with O-Ring	
5500.02	Raccordo dritto femmina Female straight fitting	
2600.41.C	Tappo femmina cromato Chrome-plated female cap	
2600.41.N	Tappo femmina nichelato Nickel plated female cap	
6200.J4	Tappo maschio con O-Ring Male cap with O-Ring	

GUIDA ALLE CONNESSIONI 6400.R8 6400.R8: CONNECTION GUIDE

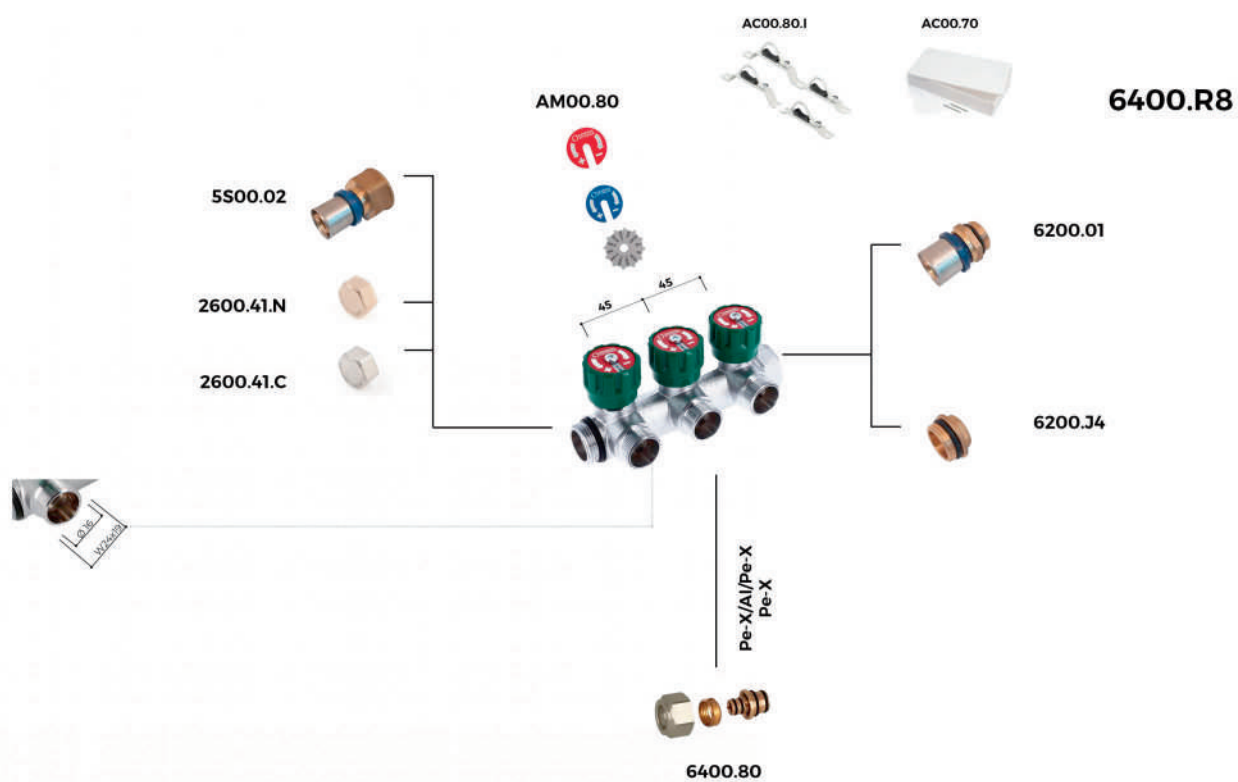

INSERTI E RACCORDI INSERTS AND FITTINGS

CODICE CODE	DESCRIZIONE DESCRIPTION	TUBO PIPE
AM00.80	Dischetto utenze Destination label	
AC00.80.I	Staffa Per collettori Flexus Bracket for Flexus manifolds	
AC00.70	Cassetta collettore Manifold cabinet	
6200.01	Raccordo dritto maschio con O-Ring Male straight fitting with O-Ring	
5500.02	Raccordo dritto femmina Female straight fitting	
2600.41.C	Tappo femmina cromato	
2600.41.N	Tappo femmina nichelato	
6200.J4	Tappo maschio con O-Ring Male cap with O-Ring	
6400.80	Dado cromato, ogiva, inserto Pipe adapter with chrome plated nut, olive and insert	tubo multistrato; tubo Pe-x multilayer pipe; Pe-X pipe

DIMENSIONI 6200.R8 6200.R8 DIMENSIONS

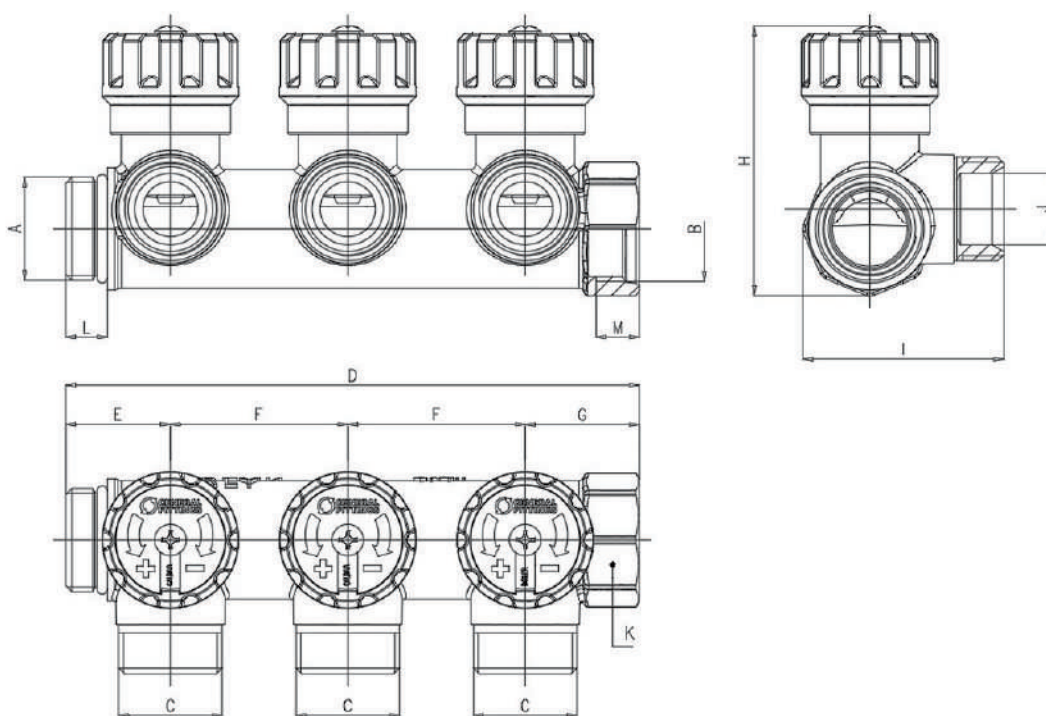

CODICE CODE	A	B	C	D	E	F	G	H	I	K	J	L
6200R8C0504V2A	G 3/4"		G 1/2"	100.5	26.5	45	29	68	51	32	Ø16,25	10.5
6200R8C0504V3A	G 3/4"		G 1/2"	145.5	26.5	45	29	68	51	32	Ø16,25	10.5
6200R8C0504V4A	G 3/4"		G 1/2"	190.5	26.5	45	29	68	51	32	Ø16,25	10.5
6200R8C1004V2A	G 1"		G 1/2"	102	27	45	30	73	57	39	Ø16,25	12
6200R8C1004V3A	G 1"		G 1/2"	147	27	45	30	73	57	39	Ø16,25	12
6200R8C1004V4A	G 1"		G 1/2"	193	27	45	31	73	57	39	Ø16,25	12

DIMENSIONI 6200.RP 6200.RP DIMENSIONS

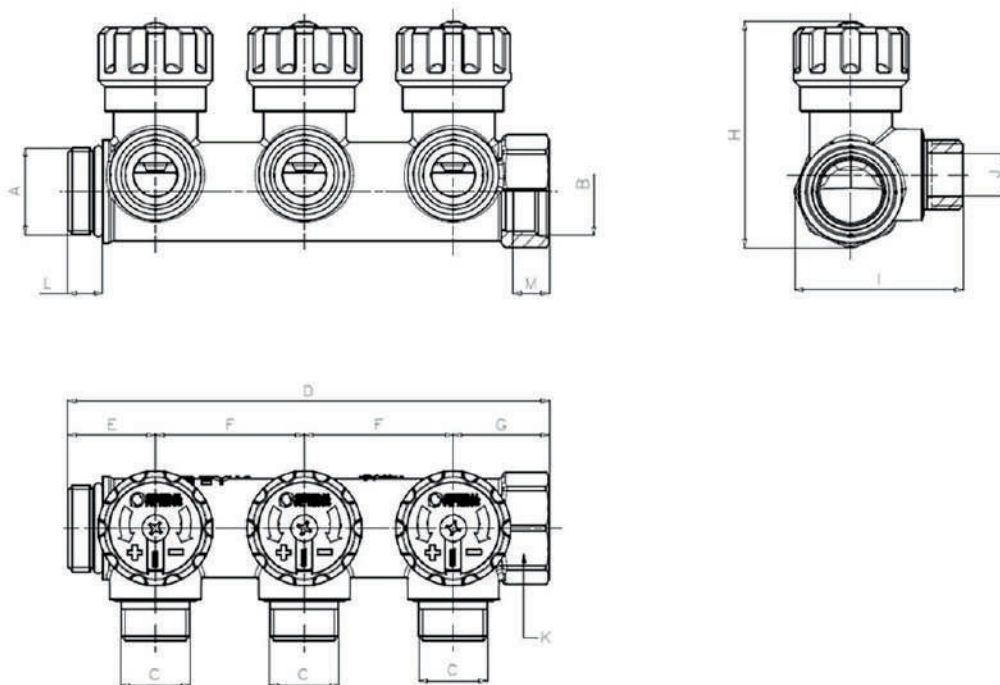

CODICE CODE	A	B	C	D	E	F	G	H	I	K	J	L
6200RPC0504V2A	G 3/4"		G 1/2"	100.5	26.5	45	29	68	51	32	Ø13	10.5
6200RPC0504V3A	G 3/4"		G 1/2"	145.5	26.5	45	29	68	51	32	Ø13	10.5
6200RPC0504V4A	G 3/4"		G 1/2"	190.5	26.5	45	29	68	51	32	Ø13	10.5
6200RPC1004V2A	G 1"		G 1/2"	102	27	45	30	73	57	39	Ø13	12
6200RPC1004V3A	G 1"		G 1/2"	147	27	45	30	73	57	39	Ø13	12
6200RPC1004V4A	G 1"		G 1/2"	193	27	45	31	73	57	39	Ø13	12

DIMENSIONI 6400.R8 6400.R8 DIMENSIONS

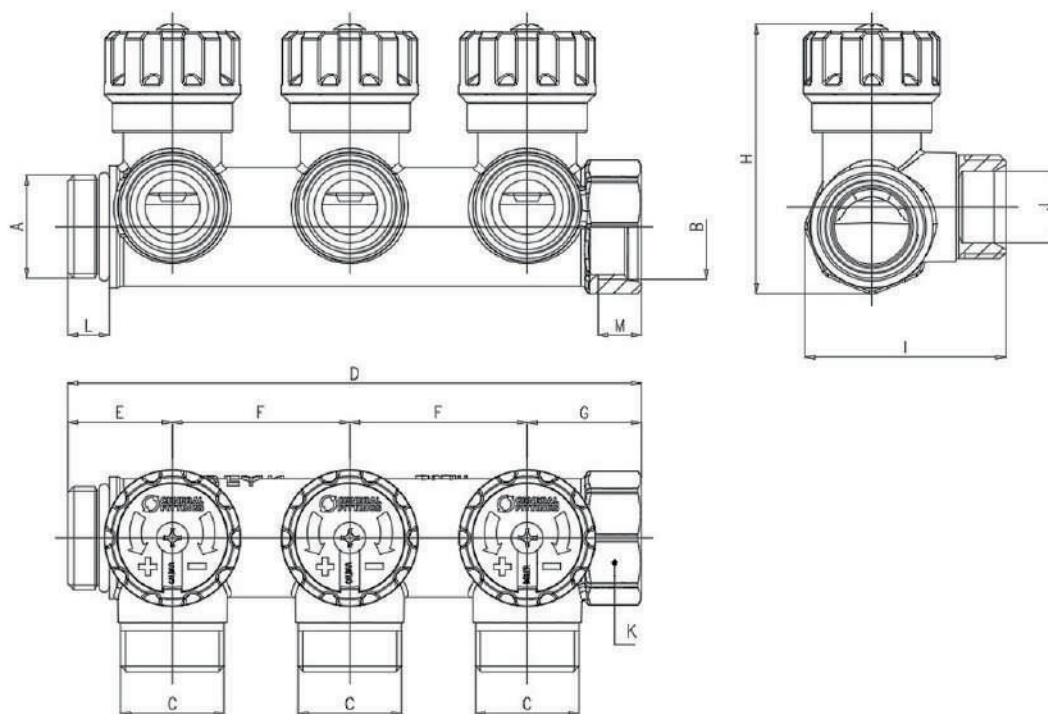





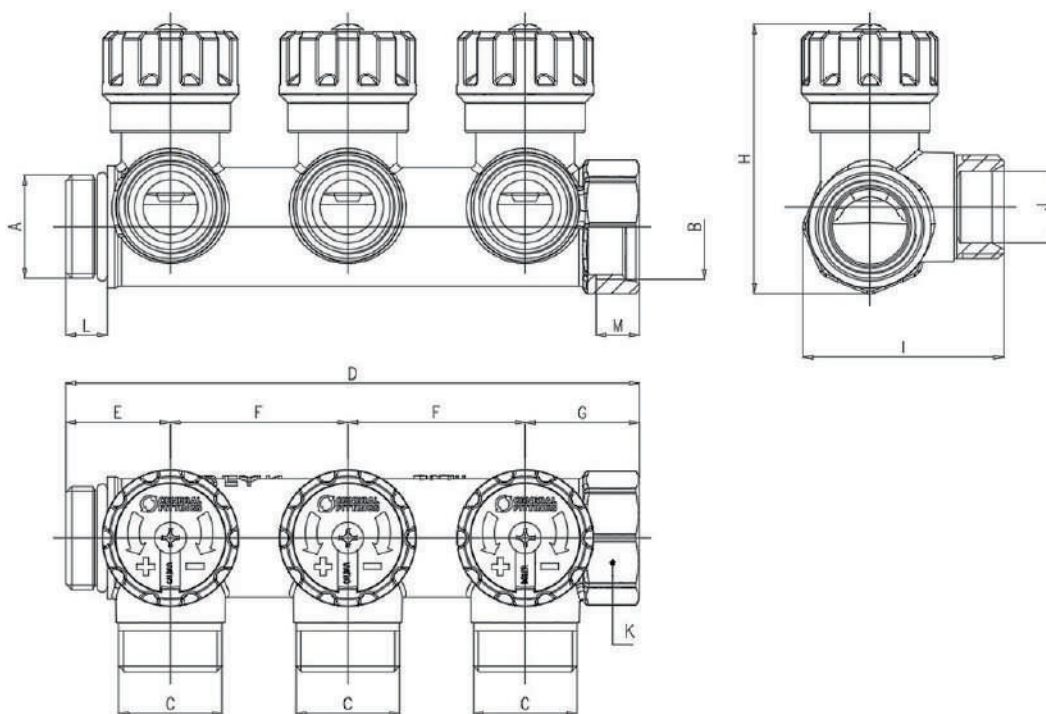





CODICE CODE	A	B	C	D	E	F	G	H	I	K	J	L
6400R8C0524V2A	G 3/4"		W24x19	100.5	26.5	45	29	68	51	32	Ø16,2	10.5
6400R8C0524V3A	G 3/4"		W24x19	145.5	26.5	45	29	68	51	32	Ø16,2	10.5
6400R8C0524V4A	G 3/4"		W24x19	190.5	26.5	45	29	68	51	32	Ø16,2	10.5
6400R8C1024V2A	G 1"		W24x19	102	27	45	30	73	57	39	Ø16,2	12
6400R8C1024V3A	G 1"		W24x19	147	27	45	30	73	57	39	Ø16,2	12
6400R8C1024V4A	G 1"		W24x19	193	27	45	31	73	57	39	Ø16,2	12

DIMENSIONI 6300.R8 6300.R8 DIMENSIONS



CODICE CODE	A	B	C	D	E	F	G	H	I	K	J	L
6300R8C0505V2A	G 3/4"			100.5	26.5	45	29	68	51	32	Ø18,1	10.5
6300R8C0505V3A	G 3/4"			145.5	26.5	45	29	68	51	32	Ø18,1	10.5
6300R8C0505V4A	G 3/4"			190.5	26.5	45	29	68	51	32	Ø18,1	10.5
6300R8C1005V2A	G 1"		G 3/4"	102	27	45	30	73	57	39	Ø18,1	12
6300R8C1005V3A	G 1"		G 3/4"	147	27	45	30	73	57	39	Ø18,1	12
6300R8C1005V4A	G 1"		G 3/4"	193	27	45	31	73	57	39	Ø18,1	12

CERTIFICAZIONI CERTIFICATIONS

STATO COUNTRY	CERTIFICAZIONE CERTIFICATION	STATO COUNTRY	CERTIFICAZIONE CERTIFICATION
			
			
			

NORMATIVE

- UNI EN ISO 228-1
Filettatura di tubazioni per accoppiamento non a tenuta sul filetto
- EN ISO 1254 parte 2,3,4
Conforme alla norma EN ISO 1254, parte 2,3,4: "Rame e leghe di rame - Raccorderia idraulica"
- Conforme a 4MS, UBA List (gruppo BC), DIN 50930/6 Dir. 2011/65/UE, 6C allegato III (RhOSII)

REGULATIONS

- UNI EN ISO 228-1:2003
Threads complies with UNI EN ISO 228-1:2003 law: "Piping thread for coupling not with tightness on the thread"
- EN ISO 1254 part 2,3,4
Copper and copper alloys - Plumbing fittings
- Comply with 4MS, UBA List (BC group), DIN 50930/6 Dir. 2011/65/UE, 6C attachment III (RhOSII).
Copper and copper alloys - Plumbing fittings
- Comply with 4MS, UBA List (BC group), DIN 50930/6 Dir. 2011/65/UE, 6C attachment III (RhOSII).

6200.R8 COLLETTORE 90° FASATO CON VITONI E DISCHETTO UTENZE
90° SELF-SEAL THREAD MANIFOLD WITH DESTINATION LABELS



CODICE				
6200R8C0504V2A	3/4"	2	1/2"	12
6200R8C0504V3A	3/4"	3	1/2"	9
6200R8C0504V4A	3/4"	4	1/2"	6
6200R8C1004V2A	1"	2	1/2"	12
6200R8C1004V3A	1"	3	1/2"	9
6200R8C1004V4A	1"	4	1/2"	6

6300.R8 COLLETTORE 90° FASATO CON VITONI E DISCHETTO UTENZE
90° SELF-SEAL THREAD MANIFOLD WITH DESTINATION LABELS



CODICE				
6300R8C0505V2A	3/4"	2	3/4" EK	12
6300R8C0505V3A	3/4"	3	3/4" EK	9
6300R8C0505V4A	3/4"	4	3/4" EK	6
6300R8C1005V2A	1"	2	3/4" EK	12
6300R8C1005V3A	1"	3	3/4" EK	9
6300R8C1005V4A	1"	4	3/4" EK	6

6400.R8 COLLETTORE 90° FASATO CON VITONI E DISCHETTO UTENZE
90° SELF-SEAL THREAD MANIFOLD WITH DESTINATION LABELS



CODICE				
6400R8C0524V2A	3/4"	2	24x19	12
6400R8C0524V3A	3/4"	3	24x19	9
6400R8C0524V4A	3/4"	4	24x19	6
6400R8C1024V2A	1"	2	24x19	12
6400R8C1024V3A	1"	3	24x19	9
6400R8C1024V4A	1"	4	24x19	6

6200.RP COLLETTORE 90° FASATO SEDE PIANA CON VITONI E DISCHETTO UTENZE
90° SELF-SEAL THREAD MANIFOLD WITH DESTINATION LABELS - FLAT SEAL



CODICE				
6200RPC0504V2A	3/4"	2	1/2"	12
6200RPC0504V3A	3/4"	3	1/2"	9
6200RPC0504V4A	3/4"	4	1/2"	6

6200.01

RACCORDO DIRITTO MASCHIO CON O-RING
 MALE STRAIGHT FITTING WITH O-RING



CODICE	+	Ø	◇	☐
620001H052020A	2.0	3/4"x20	10	80
620001H052025A	2.5	3/4"x20	-	-
620001H052630A	3.0	3/4"x26	5	50
620001H102630A	3.0	1"x26	5	40
620001H103230A	3.0	1"x32	5	40

5S00.02

RACCORDO DIRITTO FEMMINA
 FEMALE STRAIGHT FITTING



CODICE	+	Ø	◇	☐
5S0002H052020T	2.0	3/4"x20	10	50
5S0002H052022T	2.25	3/4"x20	10	50
5S0002H102630T	3.0	1"x26	5	40
5S0002H103230T	3.0	1"x32	5	30

6200.J4

TAPPO MASCHIO CON O-RING
 MALE CAP WITH O-RING



CODICE	Ø	◇	☐
6200J4H050000A	3/4"	10	200
6200J4H100000A	1"	10	100

2600.41

TAPPO FEMMINA
 FEMALE CAP



CODICE	Ø	◇	☐
260041H040000A	1/2"	10	350
260041H050000A	3/4"	10	200
260041H100000A	1"	10	100

2600.41.C TAPPO FEMMINA CROMATO
CHROME-PLATED FEMALE CAP



CODICE	Ø	◇	☐
260041C040000A	1/2"	10	350
260041C050000A	3/4"	10	200
260041C100000A	1"	10	100

MA00.70 MANOPOLA
HANDLE



CODICE

MA0070V352500H

AM00.80 DISCHETTO UTENZE
DESTINATION LABEL



CODICE	i
AM0080H274500A	aperto/chiuso
AM0080H274500H	utenze

FLEXUS

COLLETTORI SANITARI FASATI
SELF-ALIGNED MANIFOLDS



COLLETTORI DI
DISTRIBUZIONE



Collettori sanitari

Sanitary manifolds



I collettori di distribuzione lineari filettati consentono la realizzazione di circuiti caldi e/o freddi in parallelo. Possono essere inoltre utilizzati in ogni tipo di installazione idraulica [commerciale, domestica, industriale e agricola] e in linea di massima con fluidi non aggressivi. Sono disponibili, a seconda del modello, in ottone giallo e in ottone nichelato.

Linear manifolds are suitable for any kind of sanitary installation such as domestic, commercial, industry and farming. They can be used for heating and sanitary installations with any type of non-corrosive fluid. Manifolds configuration allows the realization of hot and/or cold circuits in parallel. According to the model, they are available in yellow and nickel-plated brass.

VANTAGGI





- Utilizzabili in impianti sia a bassa che ad alta temperatura
- Materie prime impiegate di alta qualità [UBA LIST]
- Adatti a tutte le tipologie di tubo plastico, metallo e metallo-plastico
- Utilizzabili in impianti sanitari e di riscaldamento

ADVANTAGES

- Suitable both for high and low temperature installations
- Raw materials complying with UBA LIST
- Suitable for plastic, metal and metal-plastic pipes
- Suitable for sanitary and heating installations.

CAMPI DI APPLICAZIONI E PRESTAZIONI

FIELDS OF APPLICATION

APPLICAZIONI APPLICATIONS		T. min.	T. max tubi metallo metal pipe	T. max tubi metallo- plastici; metal-plastic pipes	Press.max Max. pressure
	acqua potabile (solo ottone giallo) drinking water (only yellow brass)	-20°C	+120°C	+95°C	10 bar
	acqua calda sanitari (solo ottone giallo) hot sanitary water (only yellow brass)	-20°C	+120°C	+95°C	10 bar
	radiatori radiators	-20°C	+120°C	+95°C	10 bar
	-20°C: solo con liquido antigelo, glicole, in % max del 30% -20°C: only with antifreeze liquid (glycol) in % max of 30%				

MATERIALI

I collettori sanitari sono realizzati in ottone CW617N - UNI EN 12165.

MATERIALS

Sanitary manifolds are made of brass CW617N - UNI EN 12165.















NORMATIVE

- UNI EN ISO 228-1
Filettatura di tubazioni per accoppiamento non a tenuta sul filetto
- D.M. 174 (06/04/2004)
I materiali utilizzati sono conformi al Decreto Ministeriale n° 174 del 06/04/2004 [Regolamento concernente i materiali e gli oggetti che possono essere utilizzati negli impianti fissi di captazione, trattamento, adduzione e distribuzione delle acque destinate al consumo umano]
- EN ISO 1254 parte 2,3,4
Conforme alla norma EN ISO 1254, parte 2,3,4: "Rame e leghe di rame - Raccorderia idraulica"
- Conforme a 4MS, UBA List (gruppo BC), DIN 50930/6 Dir. 2011/65/UE, 6C allegato III (RhOSII)

REGULATIONS

- UNI EN ISO 228-1:2003
Threads complies with UNI EN ISO 228-1:2003 law: "Piping thread for coupling not with tightness on the thread"
- D.M. 174 (06/04/2004)
Raw materials used are of high quality and comply with the Ministerial Decree N°174 dated 06/04/2004 concerning the materials and the items used in fixed installations for water collection, treatment and supply.
- EN ISO 1254 - 2,3,4
Copper and copper alloys - Plumbing fittings
- Comply with 4MS, UBA List (BC group), DIN 50930/6 Dir. 2011/65/UE, 6C attachment III (RhOSII).

CERTIFICAZIONI CERTIFICATIONS

STATO COUNTRY	CERTIFICAZIONE CERTIFICATION	STATO COUNTRY	CERTIFICAZIONE CERTIFICATION	STATO COUNTRY	CERTIFICAZIONE CERTIFICATION
					
					
					

ISTRUZIONI DI MONTAGGIO ASSEMBLY INSTRUCTIONS

I collettori possono essere montati nell'apposita cassetta, codice AC00.70, che include il kit di fissaggio

Manifolds can be installed in AC00.70 cabinet, which includes fixing kit.



CASSETTA COLLETTORE AC00.70 AC00.70 MANIFOLDS CABINET

CODICE CODE	MISURA SIZE
AC0070H203295H	260x320x95
AC0070H204095H	260x400x95
AC0070H205095H	260x500x95

GUIDA ALLE CONNESSIONI 6300.61 6300.61 MODEL: CONNECTION GUIDE

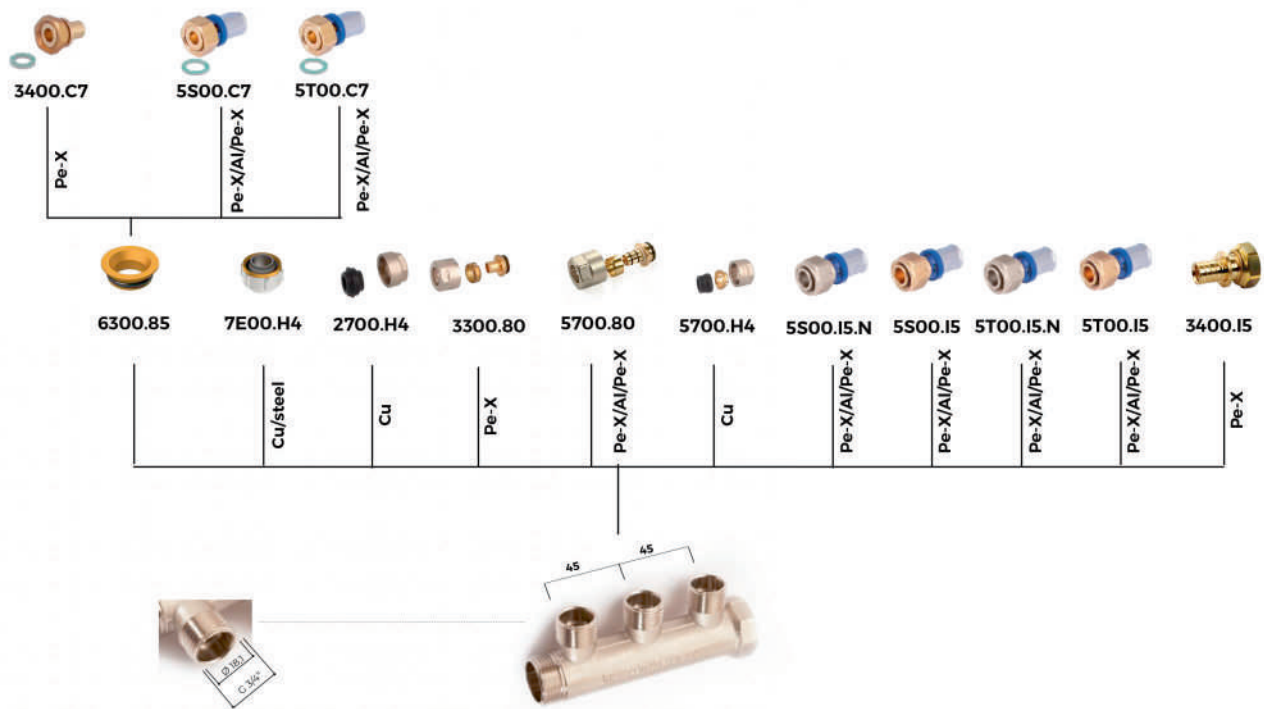

CODICE CODE	DESCRIZIONE DESCRIPTION	TUBO PIPE
7E00.H4	Kit eurocono Eurocone kit	tubo rame e tubo acciaio copper and steel pipe
6300.85	Adattatore sede piana Flat seal adapter	3400.C7: tubo Pe-X 5500.C7: tubo multistrato 3400.C7: Pe-X pipe / 5500.C7: multilayer pipe
5700.H4	Dado nichelato con ogiva e guarnizione Nickel plated nut with assembled ring and gasket	tubo rame copper pipe
2700.H4	Dado nichelato con ogiva e guarnizione Nickel plated nut with assembled ring and gasket	tubo rame copper pipe
3300.80	Dado nichelato con ogiva e inserto eurocono Nickel plated nut, olive and insert eurocone	tubo Pe-X Pe-X pipe
5700.80	Dado nichelato con ogiva e inserto eurocono Nickel plated nut, olive and insert eurocone	tubo multistrato multilayer pipe
6300.80	Dado nichelato con ogiva e inserto eurocono Nickel plated nut, olive and insert eurocone	tubo multistrato multilayer pipe
5T00.C7	Raccordo dritto sede piana con girello con guarnizione Straight fitting with loose nut and flat washer	tubo multistrato multilayer pipe
5500.C7	Raccordo dritto sede piana con girello con guarnizione Straight fitting with loose nut and flat washer	tubo multistrato multilayer pipe
3400.C7	Raccordo dritto sede piana con girello con guarnizione Straight fitting with loose nut and flat washer	tubo Pe-X Pe-X pipe
5500.I5	Raccordo dritto sede conica O-Ring con girello- Straight fitting with loose nut and conical connection	tubo multistrato multilayer pipe
5500.I5.N	Raccordo dritto nichelato sede conica O-Ring con girello- Nickel-plated straight fitting with loose nut and conical connection	tubo multistrato multilayer pipe

CODICE CODE	DESCRIZIONE DESCRIPTION	TUBO PIPE
5T00.I5	Raccordo dritto sede conica O-Ring con girello- Straight fitting with loose nut and conical connection	tubo multistrato multilayer pipe
5T00.I5.N	Raccordo dritto nichelato sede conica O-Ring con girello- Nickel-plated straight fitting with loose nut and conical con.	tubo multistrato multilayer pipe
3400.I5	Raccordo dritto sede conica O-Ring con girello Straight fitting with loose nut and eurocone	tubo Pe-X Pe-X pipe

GUIDA ALLE CONNESSIONI 2700.61 2700.61 MODEL: CONNECTION GUIDE

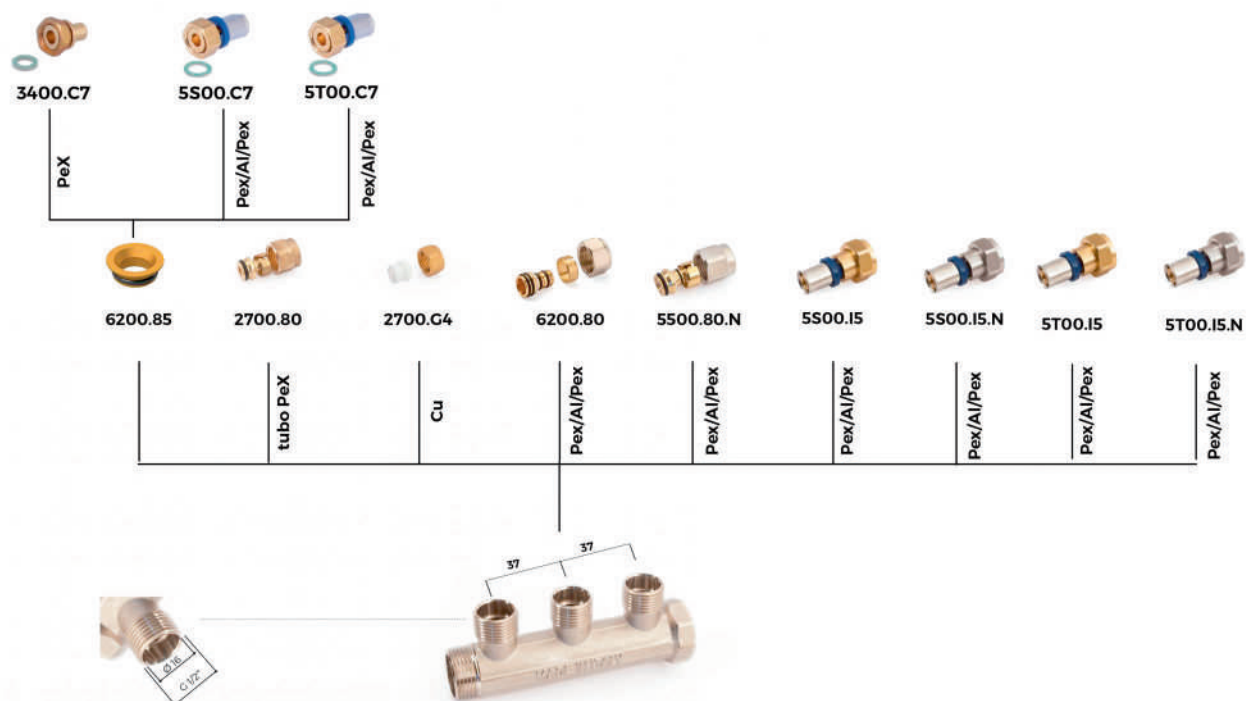

CODICE CODE	DESCRIZIONE DESCRIPTION	TUBO PIPE
6200.85	Adattatore sede piana Flat seal adapter	
2700.80	Dado, ogiva e inserto Nut, olive and insert	tubo Pe-X Pe-X pipe
2700.G4	Dado e monocono P.T.F.E Nut and monocone P.T.F.E	tubo rame copper pipe
6200.80	Dado nichelato, ogiva ed inserto Nickel-plated nut, olive and insert	tubo multistrato multilayer pipe
5500.80.N	Dado nichelato, ogiva ed inserto Nickel-plated nut, olive and insert	tubo multistrato multilayer pipe
5500.I5	Raccordo dritto sede conica O-Ring con girello- Straight fitting with loose nut and conical connection	tubo multistrato multilayer pipe
5500.I5.N	Raccordo dritto nichelato sede conica O-Ring con girello- Nickel-plated straight fitting with loose nut and conical con.	tubo multistrato multilayer pipe
5T00.I5	Raccordo dritto sede conica O-Ring con girello- Straight fitting with loose nut and conical connection	tubo multistrato multilayer pipe
5T00.I5.N	Raccordo dritto nichelato sede conica O-Ring con girello- Nickel-plated straight fitting with loose nut and conical con.	tubo multistrato multilayer pipe
3400.C7	Raccordo dritto sede piana con girello con guarnizione Straight fitting with loose nut and flat washer	tubo Pe-X Pe-X pipe
5500.C7	Raccordo dritto sede piana con girello con guarnizione Straight fitting with loose nut and flat washer	tubo multistrato multilayer pipe
5T00.C7	Raccordo dritto sede piana con girello con guarnizione Straight fitting with loose nut and flat washer	tubo multistrato multilayer pipe

GUIDA ALLE CONNESSIONI 6300.H2 6300.H2 CONNECTION GUIDE

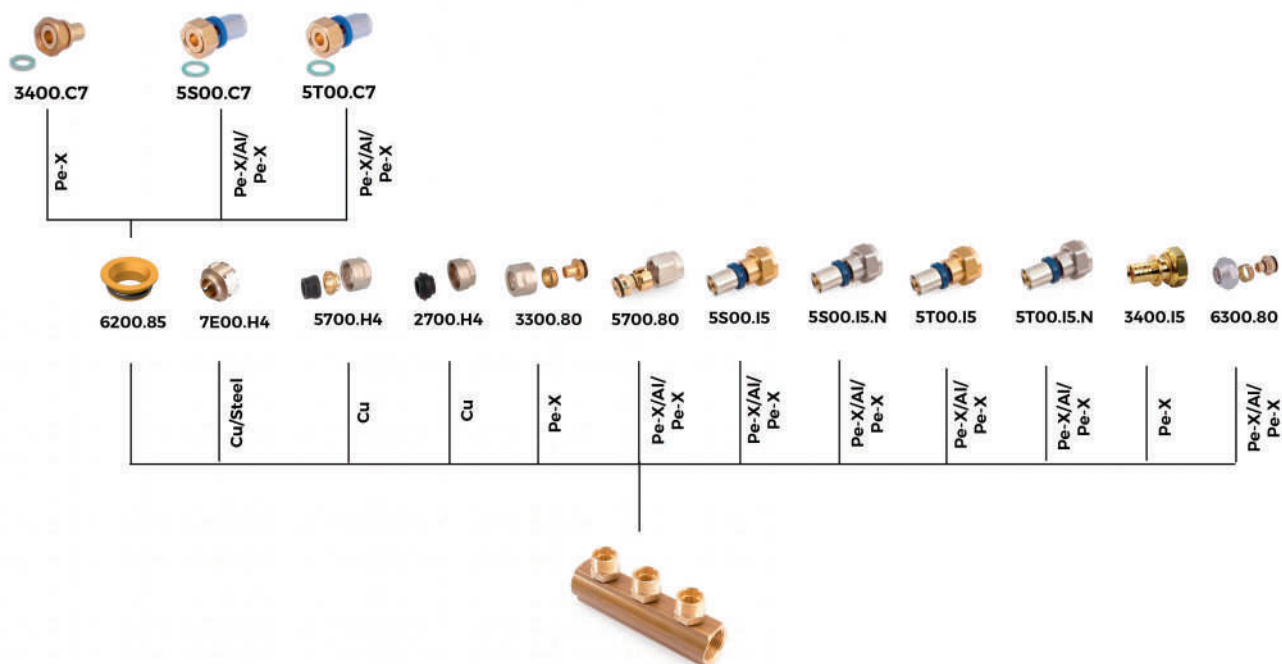

CODICE CODE	DESCRIZIONE DESCRIPTION	TUBO PIPE
6300.85	Adattatore sede piana Flat seal adapter	
5700.H4	Dado nichelato con ogiva e guarnizione incorporate Nickel-plated nut with assembled ring and gasket	tubo rame copper pipe
2700.H4	Dado nichelato con ogiva e guarnizione incorporate Nickel-plated nut with assembled ring and gasket	tubo rame copper pipe
3300.80	Dado nichelato, ogiva e inserto eurocono Nickel plated nut, olive and insert eurocone	tubo Pe-X Pe-X pipe
5700.80	Dado nichelato, ogiva e inserto eurocono Nickel plated nut, olive and insert eurocone	tubo multistrato multilayer pipe
5500.I5	Raccordo dritto sede conica O-Ring con girello- Straight fitting with loose nut and conical connection	tubo multistrato multilayer pipe
5500.I5.N	Raccordo dritto nichelato sede conica O-Ring con girello- Nickel-plated straight fitting with loose nut and conical con.	tubo multistrato multilayer pipe
5700.I5	Raccordo dritto sede conica O-Ring con girello- Straight fitting with loose nut and conical connection	tubo multistrato multilayer pipe
5700.I5.N	Raccordo dritto nichelato sede conica O-Ring con girello- Nickel-plated straight fitting with loose nut and conical con.	tubo multistrato multilayer pipe
3400.I5	Raccordo dritto sede conica O-Ring con girello Straight fitting with loose nut and eurocone	tubo Pe-X Pe-X pipe
7E00.H4	Kit eurocono nichelato Nickel plated eurocone kit	tubo rame/acciaio Copper/stainless pipe
3400.C7	Raccordo diritto sede piana con girello con guarnizione Straight fitting with loose nut and flat washer	tubo Pe-X Pe-X pipe

CODICE CODE	DESCRIZIONE DESCRIPTION	TUBO PIPE
5500.C7	Raccordo diritto sede piana con girello con guarnizione Straight fitting with loose nut and flat washer	tubo multistrato multilayer pipe
5T00.C7	Raccordo diritto sede piana con girello con guarnizione Straight fitting with loose nut and flat washer	tubo multistrato multilayer pipe

GUIDA ALLE CONNESSIONI 6400.61 6400.61 CONNECTION GUIDE



6400.80

Pe-X/Al/pe-X



CODICE CODE	DESCRIZIONE DESCRIPTION	TUBO PIPE
6400.80	Dado cromato,ogiva e inserto Chrome-plated nut, olive and insert	tubo multistrato multilayer pipe

6300.H2

COLLETTORE F/F CON RACCORDO DIRITTO PER EUROCONO
F/F MANIFOLD WITH STRAIGHT FITTING FOR EUROCONO



CODICE				
6300H2H050502A	3/4"	2	3/4" EK.	30
6300H2H050503A	3/4"	3	3/4" EK.	20
6300H2H050504A	3/4"	4	3/4" EK.	15
6300H2H050505A	3/4"	5	3/4" EK.	10
6300H2H050506A	3/4"	6	3/4" EK.	10
6300H2H050507A	3/4"	7	3/4" EK.	10
6300H2H050508A	3/4"	8	3/4" EK.	6
6300H2H050509A	3/4"	9	3/4" EK.	5
6300H2H050510A	3/4"	10	3/4" EK.	5
6300H2H050511A	3/4"	11	3/4" EK.	5
6300H2H050512A	3/4"	12	3/4" EK.	5
6300H2H100502A	1"	2	3/4" EK.	30
6300H2H100503A	1"	3	3/4" EK.	15
6300H2H100504A	1"	4	3/4" EK.	15
6300H2H100505A	1"	5	3/4" EK.	10
6300H2H100506A	1"	6	3/4" EK.	10
6300H2H100507A	1"	7	3/4" EK.	6
6300H2H100508A	1"	8	3/4" EK.	6
6300H2H100509A	1"	9	3/4" EK.	5
6300H2H100510A	1"	10	3/4" EK.	5
6300H2H100511A	1"	11	3/4" EK.	5
6300H2H100512A	1"	12	3/4" EK.	5
6300H2H120502A	1"1/4	2	3/4" EK.	15
6300H2H120503A	1"1/4	3	3/4" EK.	15
6300H2H120504A	1"1/4	4	3/4" EK.	10
6300H2H120505A	1"1/4	5	3/4" EK.	10
6300H2H120506A	1"1/4	6	3/4" EK.	10
6300H2H120507A	1"1/4	7	3/4" EK.	5

6300.H2

COLLETTORE F/F CON RACCORDO DIRITTO PER EUROCONO
F/F MANIFOLD WITH STRAIGHT FITTING FOR EUROCONO



CODICE				
6300H2H120508A	1"1/4	8	3/4" EK.	5
6300H2H120509A	1"1/4	9	3/4" EK.	5
6300H2H120510A	1"1/4	10	3/4" EK.	5
6300H2H120511A	1"1/4	11	3/4" EK.	5
6300H2H120512A	1"1/4	12	3/4" EK.	5

2700.61

COLLETTORE M/F CON ATTACCO MASCHIO
M/F MANIFOLD WITH MALE CONNECTION



CODICE				
270061H050402A	2	1/2"	3/4"	40
270061H050403A	3	1/2"	3/4"	30
270061H050404A	4	1/2"	3/4"	20
270061H100402A	2	1/2"	1"	30
270061H100403A	3	1/2"	1"	20
270061H100404A	4	1/2"	1"	15

*ad esaurimento

*until stocks are exhausted

2700.61.N COLLETTORE M/F NICHELATO CON ATTACCO MASCHIO
 NICKEL PLATED MANIFOLD M/F WITH MALE CONNECTION



CODICE			ϕ	
270061N050402A	2	1/2"	3/4"	40
270061N050403A	3	1/2"	3/4"	30
270061N050404A	4	1/2"	3/4"	20
270061N100402A	2	1/2"	1"	30
270061N100403A	3	1/2"	1"	20
270061N100404A	4	1/2"	1"	15

2700.59.N COLLETTORE M/F NICHELATO CON ATTACCO FEMMINA
 NICKEL PLATED MANIFOLD M/F WITH FEMALE CONNECTION



CODICE			ϕ	
270059N050402A	2	1/2"	3/4"	40
270059N050403A	3	1/2"	3/4"	30
270059N050404A	4	1/2"	3/4"	20
270059N100402A	2	1/2"	1"	30
270059N100403A	3	1/2"	1"	20
270059N100404A	4	1/2"	1"	15

2700.59 COLLETTORE M/F CON ATTACCO FEMMINA
 M/F MANIFOLD WITH FEMALE CONNECTION



CODICE			ϕ	
270059H050402A	2	1/2"	3/4"	40
270059H050403A	3	1/2"	3/4"	30
270059H050404A	4	1/2"	3/4"	20
270059H100402A	2	1/2"	1"	30
270059H100403A	3	1/2"	1"	20
270059H100404A	4	1/2"	1"	15

6300.61 COLLETTORE M/F
 M/F MANIFOLD



CODICE				
630061H100502A	1"	2	3/4" EK.	24
630061H100503A	1"	3	3/4" EK.	15
630061H100504A	1"	4	3/4" EK.	10

6300.61.N COLLETTORE M/F NICHELATO
NICKEL PLATED M/F MANIFOLD



CODICE				
630061N100502A	1"	2	3/4" E.K.	24
630061N100503A	1"	3	3/4" E.K.	15
630061N100504A	1"	4	3/4" E.K.	10

6400.61.N COLLETTORE M/F NICHELATO
NICKEL PLATED M/F MANIFOLD



CODICE				
640061N102402A	1"	2	24x19	24
640061N102403A	1"	3	24x19	15
640061N102404A	1"	4	24x19	10





Collettori da barra per riscaldamento

Brass-bar manifolds for heating



I collettori da barra sono disponibili sia in ottone giallo che nichelato, in una serie completa di dimensioni, da 2 a 12 vie.

Sono utilizzabili per la realizzazione di impianti di riscaldamento e sanitari. La configurazione dei collettori consente la realizzazione di circuiti caldi e/o freddi in parallelo. Hanno interasse 50mm. I fori della serie 6200.G9 sono su entrambi i lati e le derivazioni sono allineate e poste su entrambi i lati.

Numerosi accessori, come ad es. valvole a sfera di intercettazione, valvole di sfiato, rubinetti di carico-scarico, permettono di completare il collettore con tutti i componenti necessari al funzionamento ottimale dell'impianto.

Brass-bar manifolds are available in yellow and nickel-plated brass, in a complete series of sizes, from 2 to 12 ways.

Brass-bar manifolds are suitable for the realization of heating and sanitary installations. Manifolds configuration permits the realization of hot and/or cold circuits in parallel. They have center distance of 55mm.

6200.G9/6200.G9.N have holes on both sides.

Different accessories, such as air vent valves, charge/discharge valves, ball valves, allow to complete the manifold with all the necessary components for the correct operation of the system.







VANTAGGI

- Utilizzabili in impianti sia a bassa che ad alta temperatura
- Materie prime impiegate di alta qualità [UBA LIST]
- Utilizzabili con tubi plastici, metallo e metallo-plastici
- Utilizzabili per impianti di riscaldamento e raffrescamento

ADVANTAGES

- Suitable both for high and low temperature installations
- Raw materials complying with UBA LIST
- Suitable with plastic, metal and metal-plastic pipes.
- Suitable both for heating and cooling installations

CAMPI DI APPLICAZIONI E PRESTAZIONI FIELDS OF APPLICATION

APPLICAZIONI APPLICATIONS		T. min.	T. max tubi metallo T. max / metal pipes	T. max tubi metallo- plastici T. max / metal- plastic pipes	Press.max Max. pressure
	acqua calda sanitari hot sanitary water	-20°C	+120°C	+95°C	10 bar
	acqua potabile drinking water	-20°C	+120°C	+95°C	10 bar
	radiatori radiators	-20°C	+120°C	+95°C	10 bar
	riscaldamento a pavimento floor heating	-20°C	+120°C	+95°C	10 bar
	raffrescamento cooling	-20°C	+120°C	+95°C	10 bar
	-20°C: solo con liquido antigelo, glicole, in % max del 30% -20°C: only with antifreeze liquid (glycol) in % max of 30%				

MATERIALI

Lega speciale di ottone ad alto tenore di rame.

MATERIALS

Special brass alloy with a high copper content.













NORMATIVE

- UNI EN ISO 228-1
Filettatura di tubazioni per accoppiamento non a tenuta sul filetto
- EN ISO 1254 parte 2,3,4
Conforme alla norma EN ISO 1254, parte 2,3,4: "Rame e leghe di rame - Raccorderia idraulica"
- D.M. 174 (06/04/2004)
I materiali utilizzati sono conformi al Decreto Ministeriale n° 174 del 06/04/2004 [Regolamento concernente i materiali e gli oggetti che possono essere utilizzati negli impianti fissi di captazione, trattamento, adduzione e distribuzione delle acque destinate al consumo umano]
- Conforme a 4MS, UBA List (gruppo BC), DIN 50930/6 Dir. 2011/65/UE, 6C allegato III (RhOSII)

REGULATIONS

- UNI EN ISO 228-1:2003
Threads complies with UNI EN ISO 228-1:2003 law: "Piping thread for coupling not with tightness on the thread"
- EN ISO 1254 - 2,3,4
Copper and copper alloys - Plumbing fittings
- D.M. 174 (06/04/2004)
Raw materials used are of high quality and comply with the Ministerial Decree N°174 dated 06/04/2004 concerning the materials and the items used in fixed installations for water collection, treatment and supply.
- Comply with 4MS, UBA List (BC group), DIN 50930/6 Dir. 2011/65/UE, 6C attachment III (RhOSII).

CERTIFICAZIONI CERTIFICATIONS

STATO COUNTRY	CERTIFICAZIONE CERTIFICATION	STATO COUNTRY	CERTIFICAZIONE CERTIFICATION	STATO COUNTRY	CERTIFICAZIONE CERTIFICATION
					
					

ISTRUZIONI DI MONTAGGIO

Per intercettare il flusso ed agevolare eventuali opere di manutenzione, all'ingresso del collettore è possibile installare valvole di intercettazione a sfera filettate maschio (serie 7100, 7S00 e 7Y00). All'estremità del collettore è possibile installare gruppi terminali o tappi terminali per collettori.

ASSEMBLY INSTRUCTIONS

To intercept the flow and facilitate any maintenance work, male threaded ball shut-off valves (7100, 7S00 and 7Y00) can be installed at the inlet of the manifold. At the end of the manifold it is possible to install terminal groups or end caps.

6200.58COLLETTORE F/F CON INTERASSE 50 MM
F/F MANIFOLD INTERAXIS 50 MM

CODICE				
620058H050402A	3/4"	2	1/2"	30
620058H050403A	3/4"	3	1/2"	20
620058H050404A	3/4"	4	1/2"	18
620058H050405A	3/4"	5	1/2"	15
620058H050406A	3/4"	6	1/2"	15
620058H050407A	3/4"	7	1/2"	15
620058H050408A	3/4"	8	1/2"	15
620058H050409A	3/4"	9	1/2"	15
620058H050410A	3/4"	10	1/2"	15
620058H050411A	3/4"	11	1/2"	10
620058H050412A	3/4"	12	1/2"	10
620058H100402A	1"	2	1/2"	30
620058H100403A	1"	3	1/2"	20
620058H100404A	1"	4	1/2"	20
620058H100405A	1"	5	1/2"	20
620058H100406A	1"	6	1/2"	15
620058H100407A	1"	7	1/2"	10
620058H100408A	1"	8	1/2"	10
620058H100409A	1"	9	1/2"	10
620058H100410A	1"	10	1/2"	10
620058H100411A	1"	11	1/2"	10
620058H100412A	1"	12	1/2"	10
620058H120402A	1" 1/4	2	1/2"	15
620058H120403A	1" 1/4	3	1/2"	10
620058H120404A	1" 1/4	4	1/2"	8
620058H120405A	1" 1/4	5	1/2"	10
620058H120406A	1" 1/4	6	1/2"	10
620058H120407A	1" 1/4	7	1/2"	9

6200.58COLLETTORE F/F CON INTERASSE 50 MM
F/F MANIFOLD INTERAXIS 50 MM

CODICE				
620058H120408A	1" 1/4	8	1/2"	9
620058H120409A	1" 1/4	9	1/2"	8
620058H120410A	1" 1/4	10	1/2"	8
620058H120411A	1" 1/4	11	1/2"	8
620058H120412A	1" 1/4	12	1/2"	8

6200.58.N COLLETTORE F/F NICHELATO CON INTERASSE 50 MM
MM
NICKEL-PLATED F/F MANIFOLD INTERAXIS 50 MM

6200.58.N COLLETTORE F/F NICHELATO CON INTERASSE 50 MM
MM
NICKEL-PLATED F/F MANIFOLD INTERAXIS 50 MM



CODICE				
620058N050402A	3/4"	2	1/2"	30
620058N050403A	3/4"	3	1/2"	20
620058N050404A	3/4"	4	1/2"	18
620058N050405A	3/4"	5	1/2"	15
620058N050406A	3/4"	6	1/2"	15
620058N050407A	3/4"	7	1/2"	15
620058N050408A	3/4"	8	1/2"	15
620058N050409A	3/4"	9	1/2"	15
620058N050410A	3/4"	10	1/2"	15
620058N050411A	3/4"	11	1/2"	10
620058N050412A	3/4"	12	1/2"	10
620058N100402A	1"	2	1/2"	30
620058N100403A	1"	3	1/2"	20
620058N100404A	1"	4	1/2"	20
620058N100405A	1"	5	1/2"	20
620058N100406A	1"	6	1/2"	15
620058N100407A	1"	7	1/2"	10
620058N100408A	1"	8	1/2"	10
620058N100409A	1"	9	1/2"	10
620058N100410A	1"	10	1/2"	10
620058N100411A	1"	11	1/2"	10
620058N100412A	1"	12	1/2"	10
620058N120402A	1" 1/4	2	1/2"	15
620058N120403A	1" 1/4	3	1/2"	10
620058N120404A	1" 1/4	4	1/2"	8
620058N120405A	1" 1/4	5	1/2"	10
620058N120406A	1" 1/4	6	1/2"	10
620058N120407A	1" 1/4	7	1/2"	9

CODICE				
620058N120408A	1" 1/4	8	1/2"	9
620058N120409A	1" 1/4	9	1/2"	8
620058N120410A	1" 1/4	10	1/2"	8
620058N120411A	1" 1/4	11	1/2"	8
620058N120412A	1" 1/4	12	1/2"	8

6200.G9COLLETTORE F/F CON INTERASSE 50 MM
F/F MANIFOLD INTERAXIS 50 MM

CODICE				
6200G9H050402A	3/4"	2	1/2"	30
6200G9H050403A	3/4"	3	1/2"	20
6200G9H050404A	3/4"	4	1/2"	18
6200G9H050405A	3/4"	5	1/2"	15
6200G9H050406A	3/4"	6	1/2"	15
6200G9H050407A	3/4"	7	1/2"	15
6200G9H050408A	3/4"	8	1/2"	15
6200G9H050409A	3/4"	9	1/2"	15
6200G9H050410A	3/4"	10	1/2"	15
6200G9H050411A	3/4"	11	1/2"	10
6200G9H050412A	3/4"	12	1/2"	10
6200G9H100402A	1"	2	1/2"	30
6200G9H100403A	1"	3	1/2"	20
6200G9H100404A	1"	4	1/2"	25
6200G9H100405A	1"	5	1/2"	20
6200G9H100406A	1"	6	1/2"	15
6200G9H100407A	1"	7	1/2"	10
6200G9H100408A	1"	8	1/2"	10
6200G9H100409A	1"	9	1/2"	10
6200G9H100410A	1"	10	1/2"	10
6200G9H100411A	1"	11	1/2"	10
6200G9H100412A	1"	12	1/2"	10
6200G9H120402A	1"1/4	2	1/2"	15
6200G9H120403A	1"1/4	3	1/2"	10
6200G9H120404A	1"1/4	4	1/2"	8
6200G9H120405A	1"1/4	5	1/2"	10
6200G9H120406A	1"1/4	6	1/2"	10
6200G9H120407A	1"1/4	7	1/2"	9

6200.G9COLLETTORE F/F CON INTERASSE 50 MM
F/F MANIFOLD INTERAXIS 50 MM

CODICE				
6200G9H120408A	1"1/4	8	1/2"	9
6200G9H120409A	1"1/4	9	1/2"	8
6200G9H120410A	1"1/4	10	1/2"	8
6200G9H120411A	1"1/4	11	1/2"	8
6200G9H120412A	1"1/4	12	1/2"	8

6200.G9.N COLLETTORE F/F NICHELATO CON INTERASSE 50 MM
 MM
 NICKEL-PLATED F/F MANIFOLD INTERAXIS 50 MM



6200.G9.N COLLETTORE F/F NICHELATO CON INTERASSE 50 MM
 MM
 NICKEL-PLATED F/F MANIFOLD INTERAXIS 50 MM



CODICE				
6200G9N050402A	3/4"	2	1/2"	30
6200G9N050403A	3/4"	3	1/2"	20
6200G9N050404A	3/4"	4	1/2"	18
6200G9N050405A	3/4"	5	1/2"	15
6200G9N050406A	3/4"	6	1/2"	15
6200G9N050407A	3/4"	7	1/2"	15
6200G9N050408A	3/4"	8	1/2"	15
6200G9N050409A	3/4"	9	1/2"	15
6200G9N050410A	3/4"	10	1/2"	15
6200G9N050411A	3/4"	11	1/2"	10
6200G9N050412A	3/4"	12	1/2"	10
6200G9N100402A	1"	2	1/2"	30
6200G9N100403A	1"	3	1/2"	20
6200G9N100404A	1"	4	1/2"	25
6200G9N100405A	1"	5	1/2"	20
6200G9N100406A	1"	6	1/2"	15
6200G9N100407A	1"	7	1/2"	10
6200G9N100408A	1"	8	1/2"	10
6200G9N100409A	1"	9	1/2"	10
6200G9N100410A	1"	10	1/2"	10
6200G9N100411A	1"	11	1/2"	10
6200G9N100412A	1"	12	1/2"	10
6200G9N120402A	1"1/4	2	1/2"	15
6200G9N120403A	1"1/4	3	1/2"	10
6200G9N120404A	1"1/4	4	1/2"	8
6200G9N120405A	1"1/4	5	1/2"	10
6200G9N120406A	1"1/4	6	1/2"	10
6200G9N120407A	1"1/4	7	1/2"	9

CODICE				
6200G9N120408A	1"1/4	8	1/2"	9
6200G9N120409A	1"1/4	9	1/2"	8
6200G9N120410A	1"1/4	10	1/2"	8
6200G9N120411A	1"1/4	11	1/2"	8
6200G9N120412A	1"1/4	12	1/2"	8



WELCODUAL



Collettori complanari Coplanar manifolds

WELCODUAL è un collettore complanare in ottone per la distribuzione dell'acqua calda e fredda negli impianti sanitari, con rubinetti a sfera incorporati e con tutti gli attacchi, di testa e laterali, complanari, da 3/4" M (Eurocono).

WELCODUAL viene prodotto in due modelli che si differenziano unicamente per il numero degli attacchi disponibili:

- 2x2, doppio collettore complanare con due rubinetti d'intercettazione e tre attacchi in uscita di acqua calda e fredda;
- 4x4, doppio collettore complanare con due rubinetti d'intercettazione e cinque attacchi in uscita di acqua calda e fredda.

Il tipo degli attacchi disponibili consentono il collegamento al tubo multistrato WELCOFLEX ed anche ad altri tipi di tubazioni, collegabili agli attacchi Eurocono. Una cassetta in plastica, BREVETTATA, parte integrante del sistema, utilizzabile in modi differenti, agevola le operazioni per l'installazione, consente l'inserimento del collettore in pareti di ridotto spessore (7÷8 cm), protegge collettore e raccordi dal contatto diretto con le malte a base di calce (spesso molto aggressive nei confronti dell'ottone) e ne permette l'ispezione parziale o integrale.

WELCODUAL is a brass coplanar manifold for the distribution of hot and cold water in sanitary plumbing systems, with built-in ball valves and with all the connections, head and side, coplanar, 3/4" M (Eurocone). WELCODUAL is produced in two models that differ only in the number of available connections:

- 2x2, a double coplanar manifold with two shut-off valves and three hot and cold water outlet connections;
- 4x4, a double coplanar manifold with two shut-off valves and five hot and cold water outlet connections.

The type of connections available means they can be connected to the WELCOFLEX multilayer pipe and also to other types of pipes, compatible with Eurocone couplings. A PATENTED plastic case, an integral part of the system, which can be used in different ways, facilitates installation operations, allows the insertion of the manifold in thinner walls (7-8 cm), protects the manifold and fittings from direct contact with lime-based mortars (which can corrode brass) and allows partial or complete inspection.



VANTAGGI

- Impianto idrico in soli 8CM: cassetta dagli ingombri contenuti per adattarsi ai nuovi standard costruttivi.
- Fornito completo di staffe per il fissaggio sulla muratura.
- Connessioni 3/4 EUROCONO su tutti gli attacchi con possibilità di utilizzare sia raccordi a stringere che a pressare.
- Rubinetti a sfera smontabili frontalmente con passaggio totale per una manutenzione facilitata.
- Uscite calda e fredda alternate che permettono di non incrociare le tubazioni.
- Possibilità di installazione sia con coperchio di ispezione che totalmente nascosto.
- Posizionamento verticale ed orizzontale, configurabile da 3 a 5 uscite per temperatura.
- Realizzazione pratica e sicura di un sistema di distribuzione idrica in cui tutte le parti che lo compongono sono protette ed isolate dal contatto diretto con la muratura.
- Tre diverse soluzioni per il comando dei rubinetti d'intercettazione permettono di adattarsi a qualsiasi esigenza estetica.

ADVANTAGES

- A water distribution system in just 8 CM: the small case adapts to new construction standards.
- Supplied complete with brackets for fixing to masonry.
- 3/4 EUROCONO connections on all couplings with the possibility of using both compression and press fittings.
- Front-mountable full-bore ball valves for easy maintenance.
- Alternate hot and cold outlets that allow the pipes not to cross.
- Possibility of installation both with inspection cover and totally hidden.
- Vertical and horizontal positioning, configurable from 3 to 5 outlets per temperature.
- Practical and safe construction of a water distribution system in which all its component parts are protected and isolated from direct contact with the masonry.
- Three different solutions for the control of the shut-off valves allow it to be adapted to any aesthetic need.

CAMPI DI APPLICAZIONI E PRESTAZIONI FIELDS OF APPLICATION

APPLICAZIONI APPLICATIONS		T. min.	T. max	Press.max Max. pressure
	acqua potabile drinking water	-20°C	+70°C	10 bar
	acqua calda sanitari hot sanitary water	-20°C	+70°C	10 bar

IMPIANTO IDRICO IN SOLI 8CM

A WATER DISTRIBUTION SYSTEM IN JUST 8 CM

Cassetta spessore ridotto per installazione in 8cm
Reduced thickness case for installation in 8cm

Rubinetti a sfera smontabili frontalmente per una manutenzione facilitata
Front-mountable full bore ball valves for easy maintenance

Possibilità di installazione sia con coperchio di ispezione che totalmente nascosto
Possibility of installation both with inspection cover and totally hidden

Connessioni 3/4 Eurocono su tutti gli stacchi
3/4 eurocone connections on all couplings

Uscite calda e fredda alternata per non incrociare le tubazioni
Alternate hot and cold outlets not to cross pipes

Posizionamento verticale ed orizzontale, configurabile da 3 a 5 uscite di temperatura
Vertical and horizontal positioning, configurable from 3 to 5 outlets per temperature

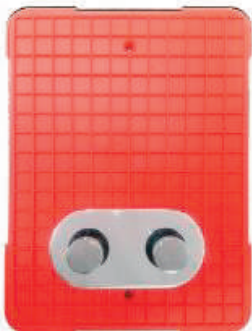

PRINCIPALI CARATTERISTICHE

- Poter essere inserito in una parete verticale di soli 8 cm, all'interno di una cassetta, realizzata in plastica con possibilità d'ispezione delle sole parti che, nel tempo, potrebbero deteriorarsi (guarnizioni o sfere dei rubinetti) oppure con ispezione integrale di tutto il collettore;
- limitare, grazie alla cassetta protettiva in plastica, le dispersioni di calore ed attenuare anche la rumorosità da scorrimento percepita;
- consentire che i due rubinetti, incorporati nel collettore, possano essere azionati, in caso di necessità, direttamente dall'utilizzatore, anche dall'esterno, senza dover quindi rimuovere alcun sportello d'ispezione;
- consentire la realizzazione di un sistema in cui tutte le parti che lo compongono siano protette ed isolate dal contatto diretto con la muratura. Collettore e raccordi sono infatti protetti all'interno della cassetta in plastica, il tubo multistrato WELCOFLEX è generalmente termoisolato con 6 mm di polietilene espanso a celle chiuse, ed anche i raccordi a tee in derivazione, eventualmente presenti sotto traccia, possono venire protetti da semi gusci in poliuretano;
- avere ridotte perdite di carico ed un ininfluyente scambio di calore tra acqua calda e fredda all'interno del collettore;
- un particolare trattamento superficiale (teflonatura) della sfera dei rubinetti, ne impedisce l'incollamento, anche dopo lunghi periodi di non utilizzo, garantendo un'elevata scorrevolezza nel tempo;
- per facilitare l'identificazione (calda o fredda?) degli attacchi laterali sulle derivazioni di uscita del collettore è stampigliata C per indicare la via calda e F per la via la fredda; inoltre per alimentare correttamente il collettore i due rubinetti hanno protezioni in plastica di diversi colori. Il rubinetto per l'acqua calda è identificato dalla protezione di colore rosso, l'acqua fredda di colore blu.

MAIN FEATURES

- *WELCODUAL can be inserted in a vertical wall of only 8 cm, set into a case made of plastic with the possibility of inspecting only the parts that, over time, could deteriorate (e.g., seals or balls of the valves) or with full inspection of the entire manifold;*
- *limit heat loss and also attenuate the noise of running water, thanks to the protective plastic case;*
- *allow the two valves, incorporated in the manifold, to be operated directly by the user if necessary, even from the outside, without having to remove an inspection door;*
- *allow the construction of a system in which all its component parts are protected and isolated from direct contact with the masonry. The manifold and fittings are in fact protected inside the plastic case, the WELCOFLEX multi-layer pipe is generally thermally insulated with 6 mm of closed-cell polyethylene foam, and even the connection tee fittings that may be chased in can be protected by polyurethane half-shells;*
- *reduce pressure drops and an irrelevant heat exchange between hot and cold water inside the manifold;*
- *a special surface treatment (Teflon coating) on the ball in the valves prevents it from sticking, even after long periods of non-use, ensuring smooth water flows over time;*
- *to make it easier to identify (hot or cold?) the side couplings on the output connections of the manifold, they are stamped with a 'C' to indicate the hot path and 'F' for the cold path; in addition, to properly feed the manifold, the two valves have plastic protections of different colours. The hot water valve is red, the cold water valve is blue.*

1. Collettore WELCODUAL installato in parete piastrellata, con rosone doppio in ABS cromato lucido e possibilità d'ispezione dei soli rubinetti, azionabili dall'esterno mediante manopole cromate.

1. WELCODUAL manifold installed in a tiled wall, with a double rose in polished chrome ABS and the possibility of inspecting only the valves, which can be operated from the outside by means of chrome-plated knobs.

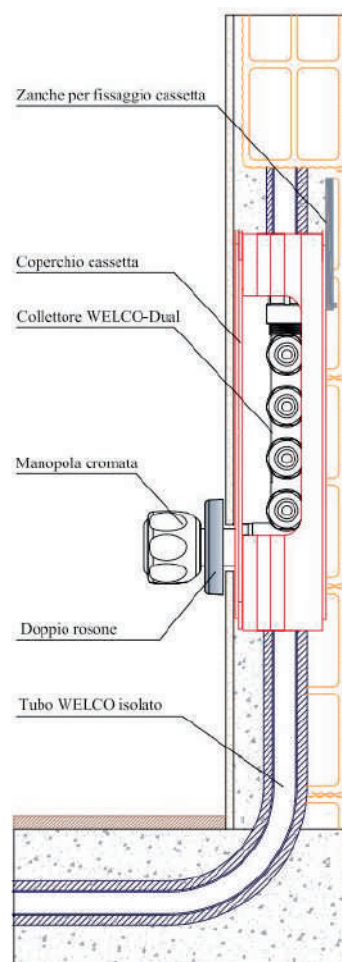

2. Collettore WELCO-Dual installato in parete piastrellata, con sportello amovibile forato colore avana, e possibilità d'ispezione del collettore e dei rubinetti, azionabili dall'esterno mediante manopole cromate.

2. WELCO-Dual manifold installed in a tiled wall, with a light brown removable perforated door, and the ability to inspect the manifold and valves, which can be operated from the outside by means of chrome-plated knobs.

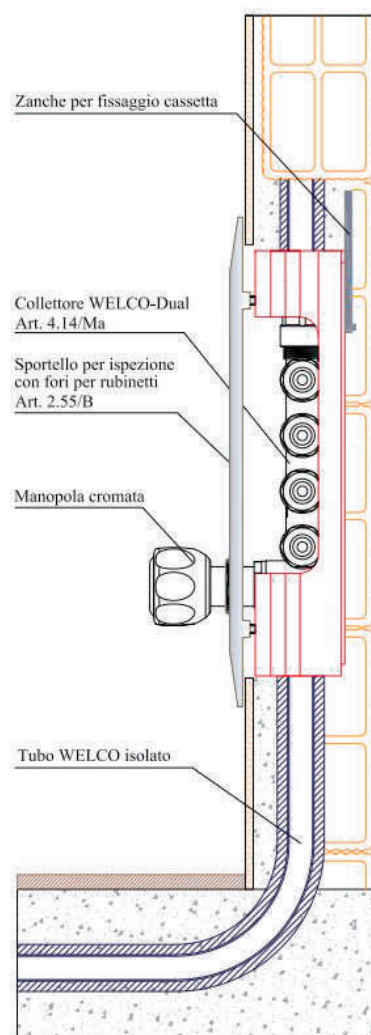

CARATTERISTICHE IDRAULICHE

Il collettore WELCODUAL si utilizza in impianti sanitari e le caratteristiche idrauliche principali sono le seguenti:

- Temperatura massima d'esercizio: 70°C
- Pressione massima d'esercizio: 10 bar
- Coefficiente di portata Kv: 2,55 m³/h

Il collettore, con rubinetto completamente aperto, ha un valore di Kv = 2,55 m³/h; una perdita di carico dovuta alla resistenza accidentale del rubinetto a sfera a cui si aggiungono le resistenze accidentali causate dalla deviazione di flusso negli attacchi laterali o dalla riduzione di passaggio negli attacchi di testa.

La perdita di carico complessiva causata dal collettore è di entità compatibile con la pressione solitamente disponibile nella maggior parte degli impianti; si consideri che con una portata di 0,72 m³/h (0,2 l/sec, portata massima necessaria per alimentare, ad esempio, una vasca da bagno) la perdita di carico del solo collettore sarà:

$$DP = (Q/Kv)^2 = (0,72/2,55)^2 = 0,0797 \text{ bar} = 79,7 \text{ mbar} =$$

HYDRAULIC DYNAMICS

The WELCODUAL manifold is used in sanitary systems. Its main hydraulic characteristics are as follows:

- Maximum operation temperature: 70°C
- Maximum operation pressure: 10 bar
- Flow coefficient Kv: 2.55 m³/h

With the valve fully open, the manifold has a Kv value = 2.55 m³/h; a pressure drop due to the inadvertent resistance of the ball valve plus the inadvertent resistance caused by flow deviation the lateral connections or by the reduction of passage in the head connections.

The total pressure drop caused by the manifold is compatible with the pressure usually available in most systems; with a flow rate of 0.72 m³/h (0.2 l/sec, the maximum flow required for a bathtub, for example), the pressure loss of the manifold alone will be:

$$DP = (Q/Kv)^2 = (0.72/2.55)^2 = 0.0797 \text{ bar} = 79.7 \text{ mbar} = 797 \text{ mm water}$$

To determine the minimum total pressure necessary upstream of the manifold, other values must also be

797 mm c.d'a.

Per determinare la pressione minima totale, necessaria a monte del collettore, dovranno essere anche noti altri valori, come lunghezza, perdita di carico unitaria del tubo, nonché le caratteristiche idrauliche dei rubinetti utilizzati.

DISTRIBUZIONE IDRAULICA

Il sistema solitamente adottato con WELCODUAL è prevalentemente del tipo a collettore, senza però escludere la possibilità di utilizzare anche qualche attacco in derivazione; l'utilizzo del collettore WELCODUAL, nei due modelli disponibili, consente differenziate soluzioni, con o senza sportello d'ispezione.

Viene inoltre offerta all'utente, in caso di necessità, la possibilità d'azionare facilmente i rubinetti d'intercettazione, incorporati nel collettore.

Il collettore WELCODUAL è quindi utilizzabile con differenti soluzioni che da un punto vista estetico, ben si adattano alle differenti finiture che normalmente ritroviamo nei bagni.

SCHEMA 1: distribuzione idraulica per l'alimentazione di un bagno con: wc, bidet, lavabo, doccia. Collettore 2x2 più un tee per derivare l'alimentazione del wc.

DIAGRAM 1: water supply distribution for a bathroom with a toilet, bidet, washbasin, and shower. 2x2 manifold plus a tee to divert water to the toilet.

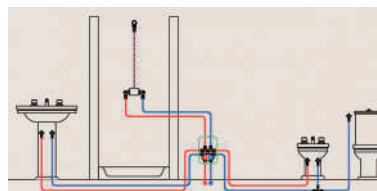

SCHEMA 2: distribuzione idraulica per l'alimentazione di bagno-cucina: wc, bidet, lavabo, doccia, lavello, lavastoviglie e lavatrice. Collettore 4x4

DIAGRAM 2: water supply distribution for a bathroom and a kitchen: toilet, bidet, washbasin, shower, sink, dishwasher and washing machine. 4x4 manifold

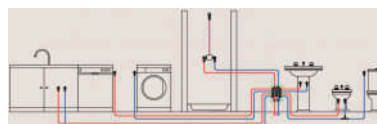

SCHEMA 3: distribuzione idraulica per l'alimentazione di un bagno con wc, bidet, lavabo, doccia. Collettore 2x2 con tee installato nella cassetta d'ispezione

DIAGRAM 3: water supply distribution to a bathroom with a toilet, bidet, washbasin, and shower. 2x2 manifold with tee installed in the inspection box

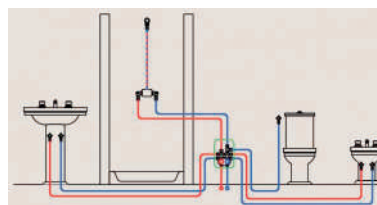

known, such as length, unit pressure drop of the pipe, as well as the hydraulic characteristics of the valves used

HYDRAULIC DISTRIBUTION

The system usually adopted with WELCODUAL is mainly of the manifold type, though it is also possible to use some branch connections. Use of the WELCODUAL manifold in the two available models makes differentiated solutions possible, with or without an inspection door.

If necessary, the user can also easily operate the shut-off valves, which are incorporated into the manifold.

The WELCODUAL manifold can therefore be used with different solutions that, from an aesthetic point of view, adapt well to the different finishes that are normally found in bathrooms.

ISPEZIONE COLLETTORE ED AZIONAMENTO RUBINETTI

Il collettore WELCODUAL, nelle diverse versioni, viene sempre inserito in un unico tipo di cassetta. Diverse sono invece le possibilità d'ispezione ed il sistema utilizzabile per l'azionamento dei rubinetti:

1) Sistema senza ispezione del collettore: non è previsto alcun sportello d'ispezione a vista sulla parete, è invece consentita l'ispezione e la sostituzione delle sole parti che nel tempo potrebbero deteriorarsi (sfere dei rubinetti).

1) System without manifold inspection: there is no visible inspection door on the wall; instead, only the parts that could deteriorate over time (valve balls) can be inspected and replaced.

Esempio: collettore 4x4 installato ed esecuzione finita con azionamento dei rubinetti mediante cappucci. E' possibile solo l'ispezione dei rubinetti e l'azionamento è sempre possibile.

Example: 4x4 manifold installed and finished with activation of the valves by means of caps. Only the valves can be inspected and activation is always possible.

2) Sistema con ispezione del collettore: è previsto uno sportello fissabile con due viti alla cassetta che consente l'integrale ispezione del collettore e dei rubinetti. L'azionamento dei rubinetti, sporgenti all'esterno, mediante due fori nello sportello, avviene direttamente.

2) System with manifold inspection: a door (fixed with two screws to the case) offers full inspection of the manifold and valves. The valves, protruding outwards, are activated directly by means of two holes in the door.

MANIFOLD INSPECTION AND VALVE OPERATION

No matter the version, the WELCODUAL manifold is always inserted in a single type of case. However, there are different options for inspection and the system that is used to operate the valves:

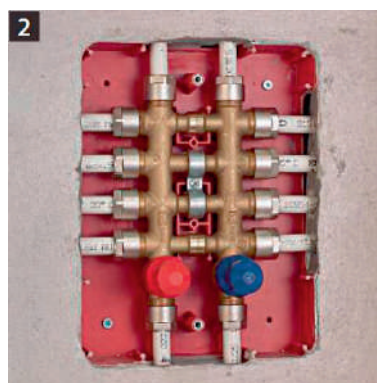
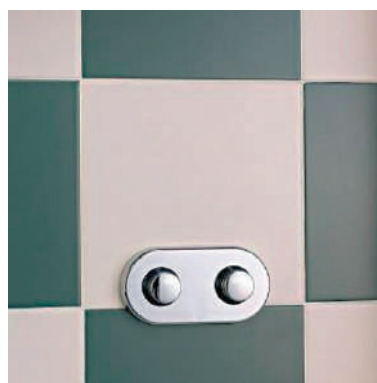
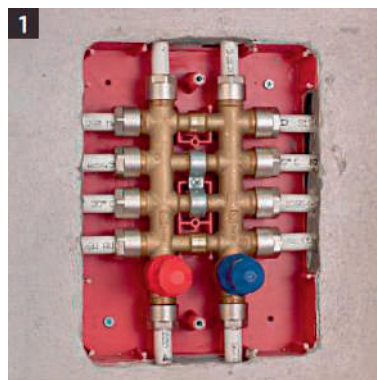

Esempio: collettore 4x4 installato ed esecuzione finita. E' possibile l'ispezione del collettore e l'azionamento dei rubinetti, dopo la semplice rimozione dello sportello.

Example: 4x4 manifold installed and finished. It is possible to inspect the manifold and operate the valves after simply removing the door.



3) Sistema con ispezione del collettore e dei rubinetti: è il sistema più tradizionale, sempre usato negli impianti a collettore; i due rubinetti, incorporati nel collettore, sono azionabili solo dopo l'apertura dello sportello.

3) System with inspection of the manifold and valves: this is the most traditional system, always used in manifold systems; the two valves, incorporated in the manifold, can be operated only after opening the door.

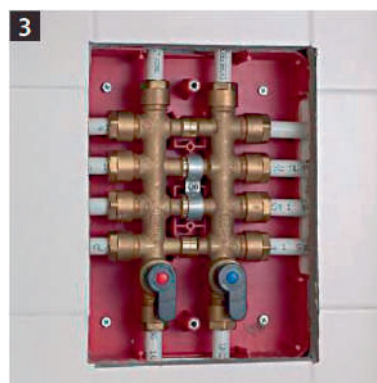

Esempio: collettore 4x4 installato ed esecuzione finita. E' possibile l'ispezione del collettore e l'azionamento dei rubinetti, dopo la semplice rimozione dello sportello.

Example: 4x4 manifold installed and finished. It is possible to inspect the manifold and operate the valves after simply removing the door.



Attacco unificato Eurocono

Standardised Eurocone connection

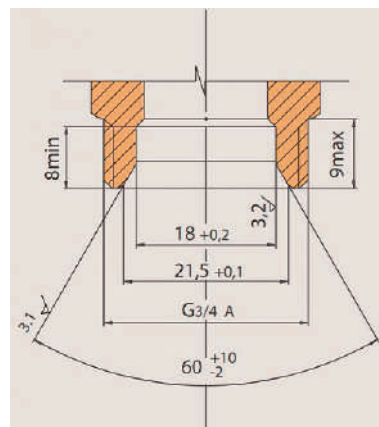

Il sistema che garantisce la tenuta tra il collettore dell'acqua calda e quello della fredda si basa sull'impiego di o-ring in EPDM 70 SH perossido. La lega d'ottone utilizzata (UNI-EN 12165 CW 617N) è, secondo le Norme Internazionali, idonea per il trasporto d'acqua potabile.

La rotazione dell'asta del rubinetto, che consente l'apertura-chiusura è, come in tutti i rubinetti a sfera, di 90° (un quarto di giro).

The system that guarantees the seal between the hot and cold water manifold is based on the use of 70 SH EPDM peroxide-cured O-rings. The brass alloy used (UNI-EN 12165 CW 617N) is, according to International Standards, suitable for the transport of drinking water.

As with all the ball valves, the rotation of the valve rod, is 90° (a quarter of a turn) to open and close it.

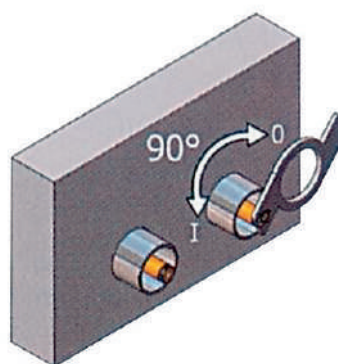

Le possibilità di intercettazione dei rubinetti sono due:

There are two valve shut-off options:

1) versione con due cappucci e la chiavetta di manovra: per l'intervento è necessario lo smontaggio dei cappucci e quindi, con la chiavetta zigrinata inserita sotto la doppia placca, si aziona il rubinetto;

1) version with two caps and an operating key: to intervene, it is necessary to disassemble the caps and then, with the knurled key inserted under the double plate, activate the valve;

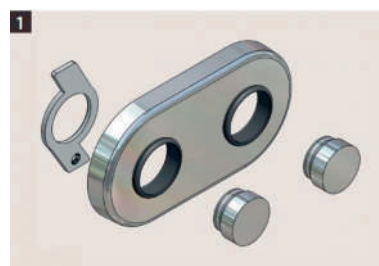

2) versione con due manopole cromate, che consentono immediatezza d'intervento in quanto, per la manovra si può intervenire direttamente sulla manopola cromata, rossa (acqua calda) o blu (acqua fredda).

2) version with two chrome knobs that make intervention immediate since it is possible to directly operate the chrome knob, either red (hot water) or blue (cold water).

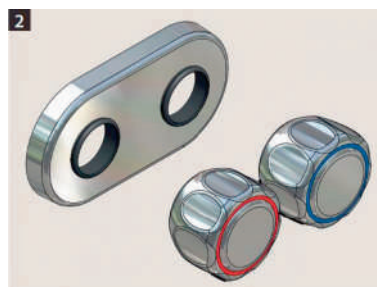

INSTALLAZIONE

Generalmente, viene previsto un collettore per ogni bagno o bagno - cucina od altre utenze sanitarie e la sua installazione avviene in fasi differenti che le illustrazioni che seguono cercano di chiarire.

Solitamente il collettore viene alimentato dal basso, l'acqua calda e fredda provengono quindi dal pavimento ed alimentano un collettore posto a parete.

Una volta individuata la posizione dove installare devono essere previste le tracce per l'alloggiamento della cassetta e per consentire il passaggio delle tubazioni; la cassetta da incasso viene facilmente fissata alla parete grazie a due apposite staffe in acciaio zincato; il collettore viene fissato alla cassetta mediante un sostegno ed un fermaglio a vite.

Come nella maggior parte dei casi, anche nell'esempio illustrato che segue l'alimentazione dell'acqua calda e fredda al collettore WELCODUAL avviene dal basso a monte dei rubinetti d'arresto.

Gli attacchi di testa collegano, sulla stessa parete del collettore, un lavabo; dagli attacchi laterali si diramano invece i collegamenti per gli apparecchi sanitari posti sulla parete opposta (doccia, bidet e, con l'aggiunta di un tee, wc).

Nell'esempio sono usati raccordi a stringere.

INSTALLATION

Generally, a manifold is provided for each bathroom or bathroom-kitchen or other sanitary facility, and it is installed in different phases that the following illustrations try to clarify

Usually the manifold is fed from below, so the hot and cold water come from the floor and enter a manifold placed within the wall.

Once the installation position has been identified, the chases for the housing of the case and to allow the passage of the pipes must be provided. The recessed case is easily set into the wall using two special galvanised steel brackets; the manifold is fixed to the case using a support and a screw fastener.

As in most cases (including in the illustrated example that follows), the hot and cold water that flows into the WELCODUAL manifold is supplied from below, upstream of the stopcocks.

On the same wall as the manifold, the head couplings connect a washbasin. Branching off from the side couplings, instead, are the connections for the sanitary fixtures placed on the opposite wall (the shower, bidet and, with the addition of a tee, the toilet).

Compression fittings are used in the example.

Fissaggio zanche alla cassetta.

Fixing clamps to the case.

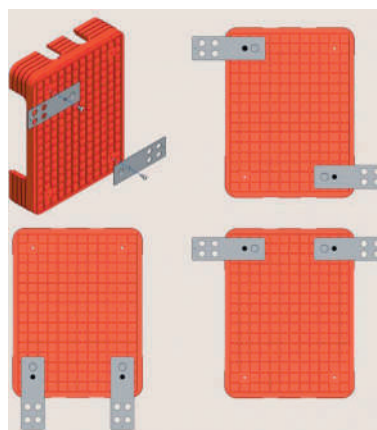

Inserimento collettore nella cassetta.

Inserting the manifold into the case.

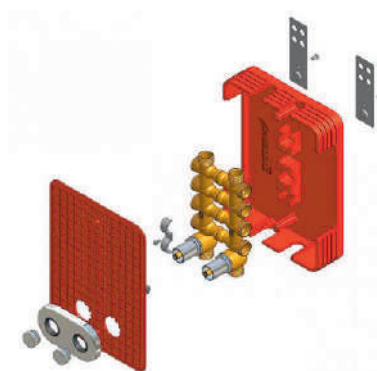

Eseguite le tracce sul tavolato, si provvede a murare la cassetta, dopo aver fissato alla stessa le due staffe in acciaio zincato, posizionate ai lati nella parte superiore della cassetta. Si provvede poi a fissare il collettore alla cassetta usando fermaglio e vite presente nella confezione.

Once the chases have been made on the boarding, the case is walled after attaching the two galvanised steel brackets, positioned on the sides at the top of the case. The manifold is then fixed to the case using a clip and screw (included in the package).



Si inizia il collegamento del tubo al collettore, prestando attenzione nella calibratura dell'estremità. Si inseriscono nel tubo gli elementi della tenuta: dado, ogiva ed inserto.

The connection of the pipe to the manifold begins, paying attention to the calibration of the end. The elements of the seal are inserted into the pipe: nut, olive and insert.



Si prosegue nel collegare le derivazioni al collettore; indispensabile, per la vicinanza degli attacchi (interasse 37 mm) sul collettore, l'uso della chiave fissa a stella.

Continue to connect the offtakes to the collector; due to the proximity of the connections (37 mm between centres) on the manifold, it is essential to use a box wrench.

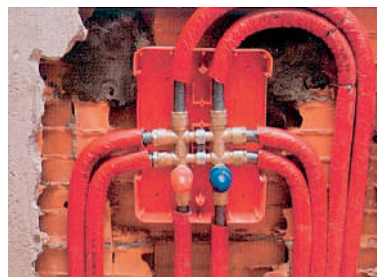

Viene quindi fissato il coperchio con le due viti (presenti nella confezione); il collettore con i due rubinetti incorporati rimane protetto. E così è consigliabile rimanga sino alla prova idraulica.

The cover is then attached with the two screws (included in the package); the manifold with the two built-in valves remains protected. It is advisable that it remains like this until the hydraulic test.

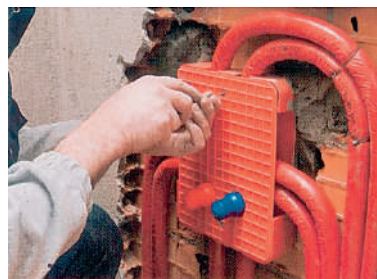

Si procede quindi al rabbocco delle tracce; una parte importante dell'installazione è ultimata. Verrà successivamente realizzato il sottofondo necessario per la posa delle piastrelle.

The chases are then grouted; at this point, a considerable part of the installation has been completed. The substrate necessary for laying the tiles will then be created.



SOSTITUZIONE DELLE GUARNIZIONI

La sostituzione delle guarnizioni si effettua dopo aver tolto, con apposito utensile (chiave a tubo), il vitone completo di sfera.

GASKETS REPLACEMENT

The gaskets are replaced after removing the screw complete with ball with a special tool (socket wrench).

INGOMBRI

DIMENSIONS

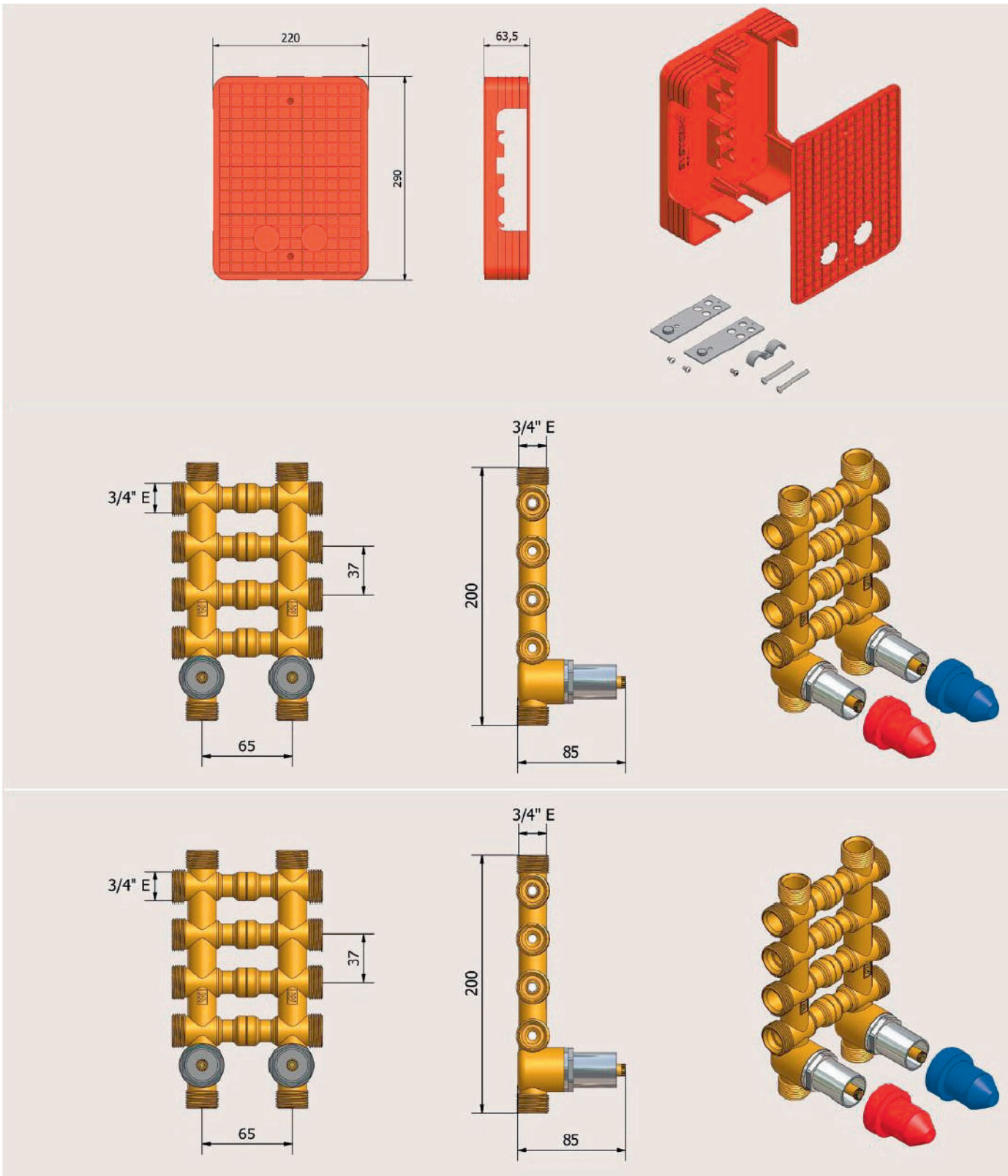

5Q00.S1 Collettore complanare 3/4" M EUROCONO
Coplanar manifold 3/4" M EK connections



CODICE



5Q00S1H050202Z

2x2

5Q00S1H050404Z

4x4

Rubinetti a sfera con cappucci cromati e chiavetta di manovra in acciaio, rosone doppio con guarnizioni in gomma e cassetta d'incasso in ABS antiurto con due zanche e fermaglio per collettore in acciaio, viti.

Ball valves with chrome-plated caps and a steel operating key, double rose with rubber seals and an anti-shock ABS recessed case with two clamps and a clip for steel manifolds, screws.

5Q00.S2 Collettore complanare 3/4" M EUROCONO
Coplanar manifold 3/4" M EK connections



CODICE



5Q00S2H050202Z

2x2

5Q00S2H050404Z

4x4

Rubinetti a sfera con manopole cromate, rosone doppio con guarnizioni in gomma e cassetta d'incasso in ABS antiurto con due zanche e fermaglio per collettore in acciaio, viti.

Ball valves with chrome knobs, double rose with rubber seals and an anti-shock ABS recessed case with two clamps and a clip for steel manifolds, screws.

5Q00.S3 Collettore complanare con rubinetti con cappucci cromati
Coplanar manifold with valves with chrome-plated caps



CODICE



5Q00S3H050202Z

2x2

5Q00S3H050404Z

4x4

Chiavetta di manovra in acciaio. Attacchi 3/4" M EUROCONO, rosone doppio con guarnizioni in gomma, cassetta con sportello d'ispezione bianco avana dotato di due fori con guarnizioni per l'azionamento dall'esterno dei rubinetti

With steel operating key. 3/4" M EUROCONO connections, double rose with rubber seals, case with a light brown blank inspection door equipped with two holes with seals for operating the valves from the outside

5Q00.S4 Collettore complanare con rubinetti con manopole cromate
Coplanar manifold with valves operated by chrome knobs



CODICE



5Q00S4H050202Z

2x2

5Q00S4H050404Z

4x4

Attacchi 3/4" M EUROCONO, rosone doppio con guarnizioni in gomma, cassetta con sportello d'ispezione bianco avana dotato di due fori con guarnizioni per l'azionamento dall'esterno dei rubinetti.

3/4" M EUROCONO connections, double rose with rubber seals, case with a light brown blank inspection door equipped with two holes with seals for operating the valves from the outside.

5Q00.S5

Collettore complanare 3/4" M EUROCONO
Coplanar manifold 3/4" M EK connections

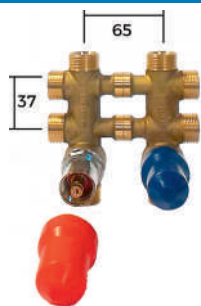
**CODICE**

5Q00S5H050202Z

2x2

5Q00S5H050404Z

4x4

Rubinetti a sfera con tappi di protezione in plastica (rosso e blu)

Ball valves with plastic protection caps (red and blue)

AC00.70.R

Cassetta per collettori WELCODUAL 2x2 e 4x4
Box for housing WELCODUAL 2x2 and 4x4 collectors

**CODICE**

AC0070R220290Z

ABS antiurto, colore mattone, completa di coperchio in plastica, due zanche a murare in acciaio zincato, fermaglio per collettore e viti

Shockproof ABS, brick colour, complete with plastic cover, two galvanised steel wall brackets, collector clip and screws.

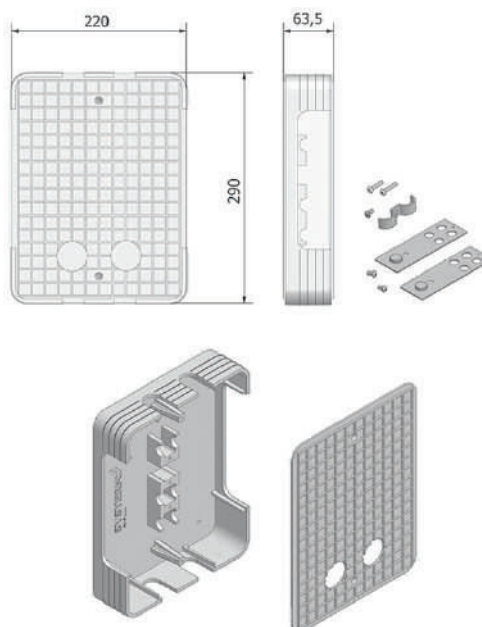

AC00.70.B Sportello BIANCO
WHITE plastic collector inspection hatch



CODICE

AC0070B245315Z

Con fori per azionamento rubinetti e viti di fissaggio a cassetta
With holes for operating taps and fixing screws to case

AC00.70.S Sportello SATINATO
MATT-CHROMED plastic collector inspection hatch



CODICE

AC0070S245315Z

Con fori per azionamento rubinetti e viti di fissaggio a cassetta
With holes for operating taps and fixing screws to case

5Q00.S6 Kit coppia di manopole
Pair of knobs kit



CODICE

5Q00S6C026500Z

5Q00.S7 Kit coppia di cappucci
Pair of caps kit



CODICE

5Q00S7C026500Z

5Q00.S8 Coppia di manopole cromate per 5Q00.S5 con cassetta
Pair of chrome-plated knobs for 5Q00.S5 with cassette



CODICE

5Q00S8C020000Z

5Q00.S9 Coppia di cappucci cromati per 5Q00.S5 con cassetta
Pair of chrome-plated knobs for 5Q00.S5 with cassette



CODICE

5Q00S9C020000Z

5Q00.A8 Sfera e vitone comando
Ball and control screw



CODICE

5Q00A8C150000Z

5Q00.43 Kit prolunga
Extension kit



CODICE

5Q0043C230000Z



40



Collettori per contatore

Water meter manifolds

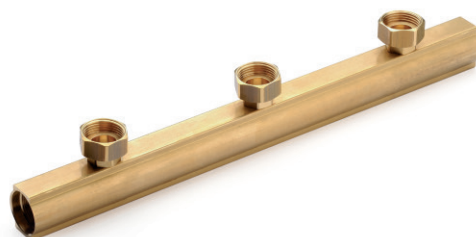

Sono utilizzati per installare i contatori acqua in linea. Hanno battuta piana ed interasse 150/200 per il posizionamento del contatore senza interferenze.

Water meter manifolds are used to install water meters in line. They have flat stop and center distance of 150/200 for the positioning of the meter without interference.

VANTAGGI



- Materie prime impiegate di alta qualità [UBA LIST]

ADVANTAGES

- Raw materials complying with UBA LIST

CAMPI DI APPLICAZIONI E PRESTAZIONI

FIELDS OF APPLICATION

APPLICAZIONI APPLICATIONS	T. min.	T. max tubi metallo T. max / metal pipes	T. max sistema tubi metallo-plastici T. max / metal- plastic pipes	Press.max Max. pressure
 acqua calda sanitari hot sanitary water	-20°C	+120°C	+95°C	10 bar
 acqua potabile drinking water	-20°C	+120°C	+95°C	10 bar
	-20°C: solo con liquido antigelo, glicole, in % max del 30% -20°C: only with antifreeze liquid (glycol) in % max of 30%			

NORMATIVE

- UNI EN ISO 228-1
Filettatura di tubazioni per accoppiamento non a tenuta sul filetto.
- EN ISO 1254 parte 2,3,4
Conforme alla norma EN ISO 1254, parte 2,3,4: "Rame e leghe di rame - Raccorderia idraulica".
- D.M. 174 (06/04/2004)
I materiali utilizzati sono conformi al Decreto Ministeriale n° 174 del 06/04/2004 [Regolamento concernente i materiali e gli oggetti che possono essere utilizzati negli impianti fissi di captazione, trattamento, adduzione e distribuzione delle acque destinate al consumo umano].
- Conforme a 4MS, UBA List (gruppo BC), DIN 50930/6 Dir. 2011/65/UE, 6C allegato III (RhOSII)

REGULATIONS

- *UNI EN ISO 228-1:2003*
Threads complies with UNI EN ISO 228-1:2003 law: "Piping thread for coupling not with tightness on the thread".
- *EN ISO 1254 - 2,3,4*
Copper and copper alloys - Plumbing fittings.
- *D.M. 174 (06/04/2004)*
Raw materials used are of high quality and comply with the Ministerial Decree N°174 dated 06/04/2004 concerning the materials and the items used in fixed installations for water collection, treatment and supply.
- *Comply with 4MS, UBA List (BC group), DIN 50930/6 Dir. 2011/65/UE, 6C attachment III (RhOSII).*

6500.60 COLLETTORE PER CONTATORE
WATER METER MANIFOLD

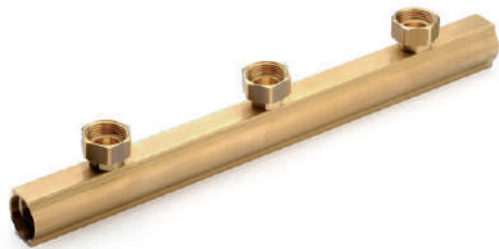

CODICE					
650060H3310C1H	M33 x 1.5	1	1"	150	20
650060H3310C3H	M33 x 1.5	3	1"	150	8
650060H3310C4H	M33 x 1.5	4	1"	150	6
650060H3310D1H	M33 x 1.5	1	1"	200	10
650060H3310D2H	M33 x 1.5	2	1"	200	8
650060H3310D3H	M33 x 1.5	3	1"	200	6
650060H3310D4H	M33 x 1.5	4	1"	200	6

6500.00 NIPLO DOPPIO
DOUBLE NIPPLE



CODICE	\varnothing		
650000H333300H	M33x1.5	5	80

6500.01 NIPLO MASCHIO CON O-RING
MALE NIPPLE WITH O-RING



CODICE	\varnothing		
650001H331000H	M33x1.5-1"	5	50

6500.44 RIDUZIONE ESAGONALE CON O-RING
HEXAGONAL REDUCTION WITH O-RING



CODICE	\varnothing		
650044H330300H	M33x1.5-3/8"	5	100



Inserti e adattatori

Inserts and adapters

Gli adattatori consentono una facile connessione alle varie tipologie di tubazioni.

The adapters allow easy connection to the various types of pipes.

VANTAGGI

- Facilità di installazione

ADVANTAGES

- *Easy to install*

2700.G4 DADO E MONOCONO P.T.F.E PER TUBO RAME
NUT AND MONOCONE P.T.F.E. FOR COPPER PIPE



CODICE	Ø	◇	☐
2700G4H041000A	1/2"x10	10	200
2700G4H041200A	1/2"x12	10	200
2700G4H041400A	1/2"x14	10	200
2700G4H041600A	1/2"x16	10	200

2700.H4 DADO NICHELATO CON OGIVA E GUARNIZIONE PER TUBO RAME
NICKEL-PLATED NUT WITH ASSEMBLED RING AND GASKET FOR COPPER PIPE



CODICE	Ø	◇	☐
2700H4N051000H	3/4"EKx10	10	200
2700H4N051200H	3/4"EKx12	10	200
2700H4N051400H	3/4"EKx14	10	200
2700H4N051500H	3/4"EKx15	10	200
2700H4N051600H	3/4"EKx16	10	200
2700H4N051800H	3/4"EKx18	10	200

5700.H4 DADO NICHELATO CON OGIVA E GUARNIZIONE PER TUBO RAME
NICKEL-PLATED NUT WITH ASSEMBLED RING AND GASKET FOR COPPER PIPE

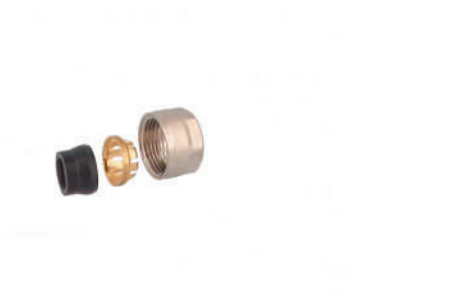

CODICE	Ø	◇	☐
5700H4N051500A	3/4"EKx15	10	100

7E00.H4 KIT EUROKONO RAME/ACCIAIO NICHELATO
NICKEL-PLATED EUROKONO ADAPTER FOR COPPER/STEEL PIPE



CODICE	Ø	◇	☐
7E00H4N051500A	3/4" EKx15	10	120

2700.80 DADO, OGIVA E INSERTO PER TUBO PE-X
NUT, OLIVE AND INSERT FOR PE-X PIPE



CODICE	+	Ø	◇	☐
270080H041220A	2.0	1/2"x12	10	150
270080H041525A	2.5	1/2"x15	10	150
270080H041615A	1.5	1/2"x16	10	150
270080H041618A	1.8	1/2"x16	10	150
270080H041620A	2.0	1/2"x16	10	150
270080H041622A	2.2	1/2"x16	10	150

3300.80 DADO NICHELATO, OGIVA E INSERTO EUROCONO
PER TUBO PE-X
NICKEL-PLATED NUT, OLIVE AND INSERT EUROCONE
FOR PE-X PIPE



CODICE	+	Ø	◇	☐
330080N051013A	1.3	3/4" EKx10	10	150
330080N051214A	1.4	3/4" EKx12	10	100
330080N051420A	2.0	3/4" EKx14	10	100
330080N051525A	2.5	3/4" EKx15	10	100
330080N051615A	1.5	3/4" EKx16	10	100
330080N051620A	2.0	3/4" EKx16	10	100
330080N051618A	1.8	3/4" EKx16	10	100
330080N051622A	2.2	3/4" EKx16	10	100
330080N051720A	2.0	3/4" EKx17	10	100
330080N051820A	2.0	3/4" EKx18	10	100
330080N051825A	2.5	3/4" EKx18	10	100
330080N052020A	1.9-2.0	3/4" EKx20	10	100
330080N052028A	2.8	3/4" EKx20	10	100

3400.15 RACCORDO DIRITTO EUROCONO CON GIRELLO
STRAIGHT FITTING WITH LOOSE NUT AND
EUROCONE CONNECTION



CODICE	+	Ø	◇	☐
3400I5H051622A	2.2	3/4"x16	10	100
3400I5H052028A	2.8	3/4"x20	10	100

6300.80 DADO NICHELATO, OGIVA E INSERTO EUROCONO
NICKEL-PLATED NUT, OLIVE AND INSERT



CODICE	+	i	Ø	◇	☐
630080N051618A	1.8	per tubo multistrato	3/4" EKx16	10	100
630080N051620A	2.0	per tubo multistrato	3/4" EKx16	10	100
630080N051720A	2.0	per tubo Pe-x	3/4" EKx17	10	100
630080N051820A	2.0	per tubo multistrato	3/4" EKx18	10	100
630080N052020A	2.0	per tubo multistrato	3/4" EKx20	10	100

5500.80.N DADO NICHELATO, OGIVA E INSERTO PER TUBO
MULTISTRATO
NICKEL-PLATED NUT, OLIVE AND INSERT EUROCONO
FOR MULTILAYER PIPE



CODICE	+	Ø	◇	☐
550080N041420T	2.0	1/2"x14	10	150
550080N041620A	2.0	1/2"x16	10	150
550080N041622A	2.25	1/2"x16	10	150
550080N051620H*	2.0	3/4"x16	10	100
550080N051622H*	2.25	3/4"x16	10	100

* fino ad esaurimento scorte

* until stocks are exhausted

6200.80 DADO NICHELATO, OGIVA E INSERTO PER TUBO
MULTISTRATO
NICKEL-PLATED NUT, OLIVE AND INSERT EUROCONO
FOR MULTILAYER PIPE



CODICE	+	Ø	◇	☐
620080N041620A	2.0	1/2"x16	10	150

5700.80 DADO NICHELATO, OGIVA E INSERTO EUROCONO
PER TUBO MULTISTRATO
NICKEL-PLATED NUT, OLIVE AND INSERT EUROCONO
FOR MULTILAYER PIPE



CODICE	+	Ø	◇	☐
570080N051216A	1.6	3/4" EKx12	10	100
570080N051620A	2.0	3/4" EKx16	10	100
570080N051622A	2.25	3/4" EKx16	10	100
570080N051720A	2.0	3/4" EKx17	10	100
570080N051820A	2.0	3/4" EKx18	10	100
570080N052020A	2.0	3/4" EKx20	10	100
570080N052022A	2.25	3/4" EKx20	10	100
570080N052025A	2.5	3/4" EKx20	10	100

5S00.I5 RACCORDO DRITTO SEDE CONICA O-RING
CON GIRELLO
STRAIGHT FITTING WITH LOOSE NUT
AND CONICAL CONNECTION



CODICE	+	Ø	◇	☐
5S00I5H041620T	2.0	1/2"x16	10	100
5S00I5H042020T	2.0	1/2"x20	10	100
5S00I5H042022T	2.25	1/2"x20	-	100
5S00I5H051620T	2.0	3/4" EKx16	10	100
5S00I5H051820T	2.0	3/4" EKx18	10	100
5S00I5H052020T	2.0	3/4" EKx20	10	80
5S00I5H052022T	2.25	3/4" EKx20	-	80

5S00.I5.N RACCORDO DRITTO NICHELATO SEDE CONICA
O-RING CON GIRELLO
NICKEL-PLATED STRAIGHT FITTING WITH LOOSE
NUT AND CONICAL CONNECTION



CODICE	+	Ø	◇	☐
5S00I5N041620T	2.0	1/2"x16	10	100
5S00I5N042020T	2.0	1/2"x20	10	100
5S00I5N042022T	2.25	1/2"x20	10	100
5S00I5N051620T	2.0	3/4" EKx16	10	100
5S00I5N051820T	2.0	3/4" EKx18	10	100
5S00I5N052020T	2.0	3/4" EKx20	10	80
5S00I5N052022T	2.25	3/4" EKx20	10	80

5T00.I5 RACCORDO DRITTO SEDE CONICA O-RING
CON GIRELLO
STRAIGHT FITTING WITH LOOSE NUT
AND CONICAL CONNECTION



CODICE	+	Ø	◇	☐
5T00I5H041620T	2.0	1/2"x16	10	100
5T00I5H042020T	2.0	1/2"x20	10	100
5T00I5H051620T	2.0	3/4"EK. x16	10	100
5T00I5H052020T	2.0	3/4"EK. x20	10	80

5T00.I5.N RACCORDO DRITTO NICHELATO SEDE CONICA
O-RING CON GIRELLO
NICKEL-PLATED STRAIGHT FITTING WITH LOOSE NUT
AND CONICAL CONNECTION



CODICE	+	Ø	◇	☐
5T00I5N041620T	2.0	1/2"x16	10	100
5T00I5N042020T	2.0	1/2"x20	10	100
5T00I5N051620T	2.0	3/4"EK.x16	10	100
5T00I5N052020T	2.0	3/4"EK.x20	10	80

6300.80NX DADO NICHELATO, OGIVA E INSERTO EUROCONO
 NICKEL-PLATED NUT, OLIVE AND INSERT EUROCONE



CODICE	+	i	Ø	◇	☐
630080NX51626A	2.6	Pe-x Al Pe-x 16x2.6	3/4" EKx16	10	100
630080NX52029A	2.9	Pe-x Al Pe-x 20x2.9 Pe-x 20x2.8 Pe-x 20x2.8	3/4" EKx20	10	100

6200.80NX DADO NICHELATO, OGIVA E INSERTO PER TUBO
 MULTISTRATO
 NICKEL-PLATED NUT, OLIVE AND INSERT EUROCONE
 FOR MULTILAYER PIPE



CODICE	+	Ø	◇	☐
620080NX41626A	2.6	1/2"x16	10	150

6400.80.C DADO CROMATO, OGIVA E INSERTO PER TUBI PE-
 X,PE-RT,MULTISTRATO
 CHROME-PLATED NUT, OLIVE AND INSERT FOR PE-
 X,PE-RT,PE-X/AL/PE-X PIPES



CODICE	+	Ø	◇	☐
640080C241620A	16x2.0	24x19	10	100
640080C241820A	18x2.0	24x19	10	100
640080C242020A	20x2.0	24x19	10	100



ADATTATORI SEDE PIANA FLAT SEAL ADAPTERS

Gli adattatori consentono una facile connessione alle varie tipologie di tubazioni.

The adapters allow easy connection to the various types of pipes.



6200.85 ADATTATORI A SEDE PIANA
FLAT SEAL ADAPTER



CODICE			
620085H040000H	1/2"	10	800

6300.85 ADATTATORE SEDE PIANA EUROKONO
EUROKONE FLAT SEAL ADAPTER



CODICE			
630085H050000H	3/4"	10	500



ACCESSORI COLLETTORI DI DISTRIBUZIONE DISTRIBUTION MANIFOLD ACCESSORIES

General Fittings propone una vasta gamma di accessori e staffe per l'installazione dei collettori di distribuzione.

General Fittings offers a wide range of accessories and brackets for the installation of manifolds.

VANTAGGI

- Completezza della gamma
- Un unico interlocutore per raccordi, tubi, collettori, accessori e attrezzature

ADVANTAGES

- *Complete range*
- *One partner for fittings, pipes, manifolds, accessories and tools.*

7S00.M5 VALVOLA A SFERA M/F BOCCHETTONE CON FARFALLA
M/F STRAIGHT UNION BALL VALVE WITH BUTTERFLY



CODICE	i	Ø	◇	☐
7S00M5N0505B2A	Blu	3/4"	8	32
7S00M5N0505R2A	Rosso	3/4"	8	32
7S00M5N1010B2A	Blu	1"	5	20
7S00M5N1010R2A	Rosso	1"	5	20
7100M5N1212B2A	Blu	1 1/4"	-	10
7100M5N1212R2A	Rosso	1 1/4"	-	10

7Y00.M6 VALVOLA A SFERA COMPATTA BOCCHETTONE CON FARFALLA CON TERMOMETRO
COMPACT BALL VALVE COUPLING WITH BUTTERFLY AND THERMOMETER



CODICE	i	Ø	☐
7Y00M6N1010R2A	Rosso	1"	12
7Y00M6N1010B2A	Blu	1"	12

7Y00.M8 VALVOLA A SFERA COMPATTA A SQUADRA BOCCHETTONE CON FARFALLA NO TERMOMETRO
COMPACT 90-DEGREE BALL VALVE COUPLING WITH BUTTERFLY, NO THERMOMETER



CODICE	i	Ø	☐
7Y00M8N1010R2A	Rosso	1"	12
7Y00M8N1010B2A	Blu	1"	12

AC00.80.I STAFFA PER COLLETTORI FLEXUS
BRACKETS FOR FLEXUS MANIFOLDS



CODICE	H	☐
AC0080I05B290A	intera 133 / divisa > 133	10
AC0080I10B290A	intera 133 / divisa > 133	10

AC0080I05B290A compatibile con seguenti codici/misure: 6200.E7/6300.E7 3/4" e 1" - 6200.R6 3/4" - 6200.R8 3/4" - 6200.RP 3/4" - 6300.R8 3/4" - 6400.R8 3/4" - 2700.59 3/4" - 2700.61 3/4" - 6M00.88 1" - 6M00.90 1" - 6M00.99 1".
AC0080I10B290A compatibile con seguenti codici/misure: 6200.R6 1" - 6200.R8 1" - 6200.RP 1" - 6300.R8 1" - 6400.R8 1" - 2700.59 1" - 2700.61 1".

AC0080I05B290A compatible with the following codes/sizes: 6200.E7/6300.E7 3/4" and 1" - 6200.R6 3/4" - 6200.R8 3/4" - 6200.RP 3/4" - 6300.R8 3/4" - 6400.R8 3/4" - 2700.59 3/4" - 2700.61 3/4" - 6M00.88 1" - 6M00.90 1" - 6M00.99 1".
AC0080I10B290A compatible with the following codes/sizes: 6200.R6 1" - 6200.R8 1" - 6200.RP 1" - 6300.R8 1" - 6400.R8 1" - 2700.59 1" - 2700.61 1".

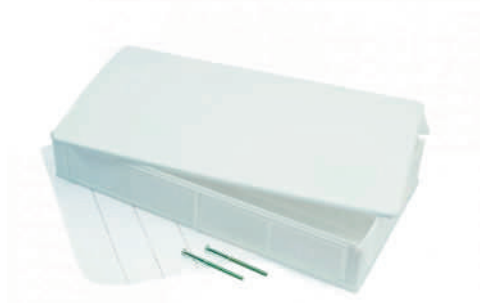
AC00.70CASSETTA COLLETTORE
MANIFOLD CABINET

CODICE	Ø	
AC0070H203295H	260x320x95	20
AC0070H204095H	260x400x95	20
AC0070H205095H	260x500x95	10

Kit di fissaggio incluso. Cassette compatibili con le linee di COLLETTORI SANITARI di General Fittings Spa. Per ulteriori informazioni si prega di contattare l'Ufficio Tecnico di General Fittings Spa.

Fixing kit included. Cabinets compatible with General Fittings' sanitary manifolds. For further information please contact General Fittings' technical department.

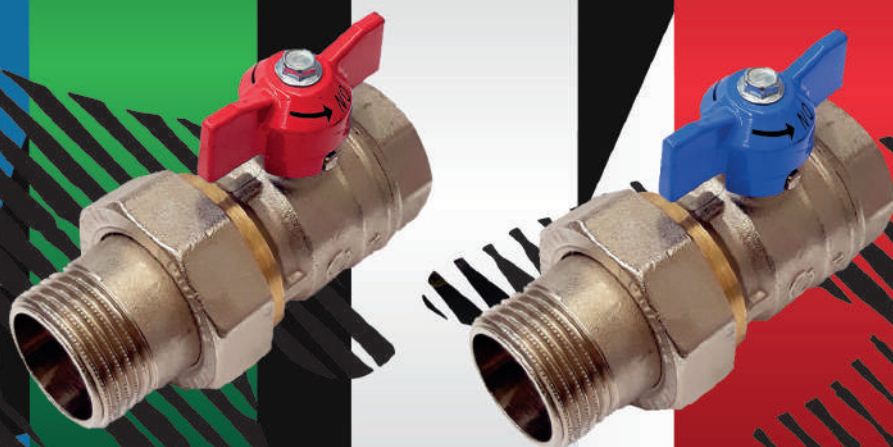

ACCESSORI COLLETTORI
DISTRIBUZIONE
DISTRIBUTION MANIFOLD
ACCESSORIES

COLLETTORI
IMPIANTI
RADIANTI
MANIFOLDS
FOR RADIANT
SYSTEMS

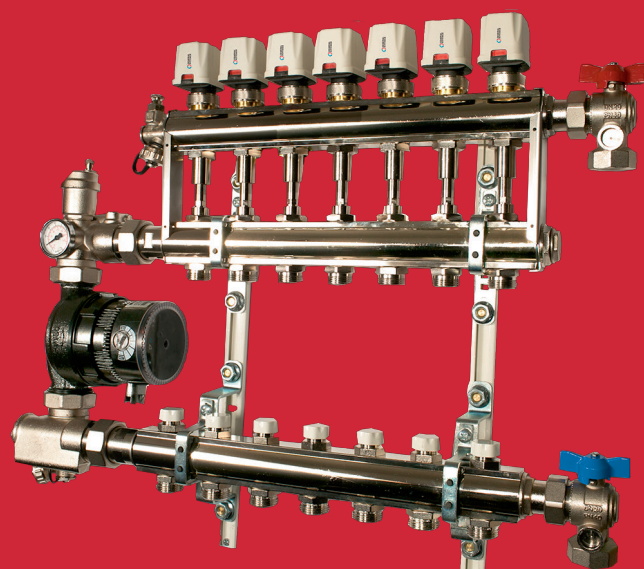



TRITONE

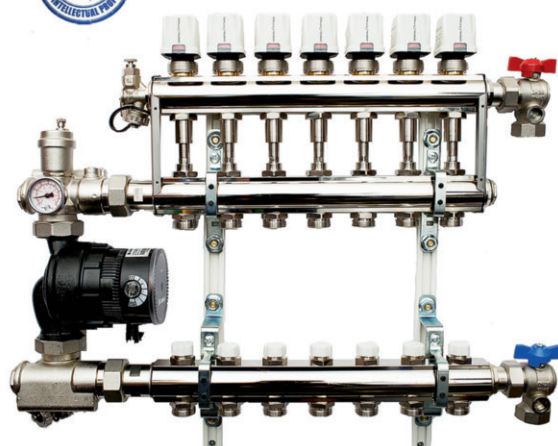

Centralina di miscelazione Mixing unit

TRITONE è la centralina di miscelazione ad iniezione compatta (occupa spazi ridotti) ALL IN ONE, per la distribuzione dell'acqua calda sia in bassa sia in alta temperatura negli impianti di riscaldamento e raffrescamento.

Trova impiego sia con generatori di calore ad alta che a bassa temperatura.

È stata studiata da General Fittings per dare una risposta concreta alla richiesta di architetti e tecnici di massima libertà nella progettazione degli impianti: in questo modo il progettista è slegato dal vincolo dei tempi per la definizione del tipo di copertura oppure dell'impianto esistente in caso di ristrutturazioni evitandone così la sostituzione.

TRITONE è una centralina di miscelazione a portata costante e temperatura regolabile per ogni singolo circuito in modo indipendente.

TRITONE is an all in one compact injection mixing control unit for the distribution of water at high and low temperature, for heating and cooling system. Compatible with all high and low temperature generators.

In order to give a real answer to the market requirements, TRITONE has been developed and created by GENERAL FITTINGS to ease the job of architects, engineers and installers in the realization of the systems.

TRITONE is a mixing control unit with constant flow and adjustable temperature for each single circuit independently.





VANTAGGI

- Brevettato
- Ideale per tutti i tipi di impianti e generatori di calore
- E' possibile gestire temperature diverse nei vari ambienti
- Con un unico collettore è possibile controllare impianti in alta e bassa temperatura
- Massima libertà di scelta del tipo di pavimento anche dopo l'installazione
- Compatibile con i sistemi domotici integrati
- Silenzioso
- Temperatura circuito regolabile + portata costante = maggior comfort
- Raffreddamento degli ambienti più lento
- Meno accensioni del generatore di calore = maggior comfort
- Funziona sia in impianti di riscaldamento che di raffrescamento

ADVANTAGES

- *Patented*
- *Ideal for all types of systems and heat generators*
- *It is possible to manage different temperatures in each room*
- *Unique manifold for low as well as for high temperature heating systems.*
- *Freedom of floor covering selection (even after installation)*
- *Compatible with integrated domotic systems*
- *Silent*
- *Adjustable circuit temperature + constant flow rate = greater comfort*
- *Slower room cooling*
- *Less starts of the heat generator = greater comfort*
- *It works both with heating and cooling systems*

CAMPI DI APPLICAZIONI E PRESTAZIONI FIELDS OF APPLICATION

APPLICAZIONI APPLICATIONS		T. max	Press.max Max. pressure
	riscaldamento a pavimento low temperature heating (floor)	+80°C	7 bar
	riscaldamento a parete low temperature heating (wall)	+80°C	7 bar
	riscaldamento a soffitto low temperature heating (ceiling)	+80°C	7 bar
	radiatori radiators	+80°C	7 bar
	raffrescamento cooling	+80°C	7 bar

TEMPERATURE DIFFERENTI NEI DIVERSI AMBIENTI

DIFFERENT TEMPERATURES FOR EACH ROOM



Grazie alle sue peculiarità la centralina Tritone consente di poter regolare le temperature nei vari ambienti in modo semplice ed immediato, superando così la distinzione tra ambiente "sfavoriti" e "favoriti".

La temperatura del liquido nei vari ambienti è regolabile in pochi e semplici passaggi.

La portata del liquido fornita dal generatore di calore è costante in tutti gli ambienti.

TRITONE overcomes the distinction between advantaged and disadvantaged position rooms.

You can set the circuit temperature of the rooms in a very few easy steps.

The flow rate supplied by the generator is kept constant in all the rooms.

GENERATORI A CUI COLLEGARE TRITONE GENERATORS TO CONNECT TRITONE TO

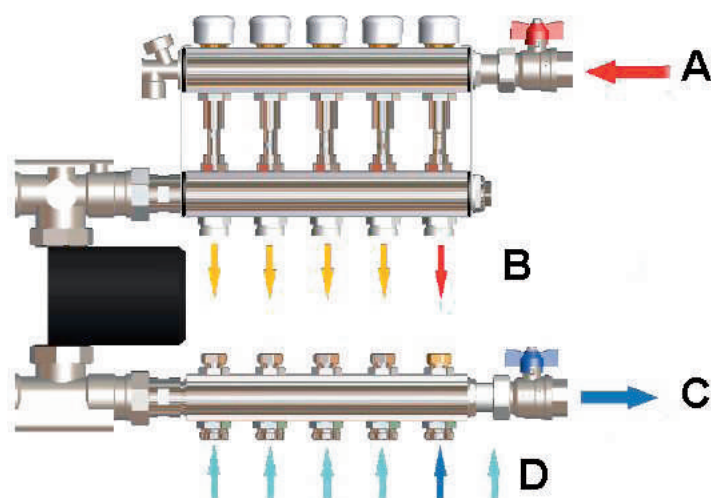

LEGENDA LEGEND	DESCRIZIONE DESCRIPTION
A	MANDATA DAL GENERATORE DI CALORE ENTRY FLOW FROM HEAT GENERATOR (PRIMARY)
B	RITORNO AL GENERATORE DI CALORE RETURN TO HEAT GENERATOR (PRIMARY)
C	MANDATA AI CIRCUITI E TERMOARREDI ENTRY FLOW TO LOOPS AND HEATED TOWEL RACKS (SECONDARY)
D	RITORNO AI CIRCUITI E TERMOARREDI RETURN FLOW FROM LOOPS AND HEATED TOWEL RACKS (SECONDARY)

La centralina ad iniezione TRITONE può essere alimentata da qualsiasi generatore di calore che produca acqua a bassa temperatura (30°-45°C) e anche acqua ad alta temperatura, fino ad un massimo di 80°C (temperatura consigliata: max 70°C).

I più comuni generatori di acqua calda sono:

- Caldaia a camera stagna
- Caldaia a condensazione
- Caldaie a biomasse/termocamino
- Pompe di calore
- Scambiatori geotermici
- Tutti i generatori di calore che garantiscono una portata costante al collettore

The TRITONE injection control unit can be fed by any heat generator which produces low temperature water (30 °C-45 °C) or high temperature water, to a maximum of 80 °C (suggested temperature: max 70 °C).

The most common types of hot water generators are:

- Sealed chamber boiler
- Condensation boiler
- Biomass/fireplace boilers
- Heat pumps
- Geo-heat exchangers
- All heat generators that guarantee a constant flow rate to the manifold

RUMOROSITA'

TRITONE è equipaggiato con circolatore di nuova generazione estremamente silenzioso. Per questo motivo la centralina di miscelazione può essere installata in qualsiasi ambiente, anche in quelli più sensibili al rumore (camere ad esempio). Il livello di rumorosità è 22,8 dB.

NOISE LEVEL

TRITONE is equipped with an extremely silent latest generation pump. This allows the mixing control unit to be installed in any room, even those more sensitive to heat (for example bedrooms). The noise level is 22.8 dB.

SCHEMA IDRAULICO HYDRAULIC DIAGRAM

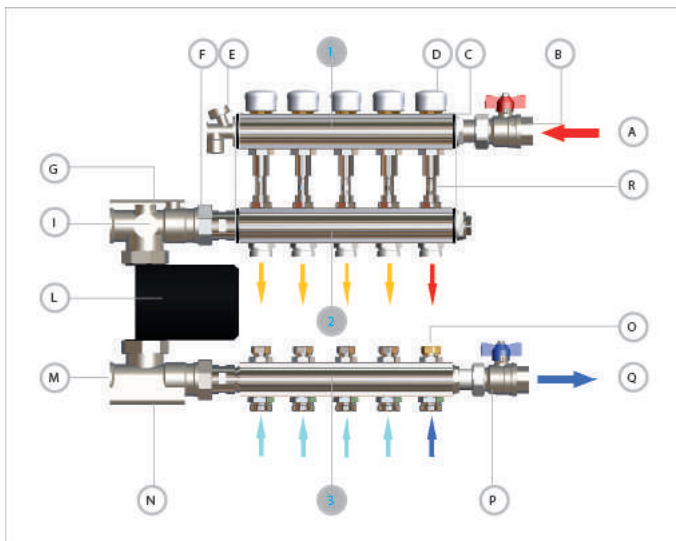

LEGENDA LEGEND	ELEMENTO ELEMENT	LEGENDA LEGEND	ELEMENTO ELEMENT
A	Acqua calda dal generatore Hot water from generator	I	Termometro Thermometer
B	Valvola di intercettazione primario andata Entry flow primary circuit shut-off valve	L	Circolatore (secondo normative ERP sul risparmio energetico) Pump
C	Attuatore meccanico Mechanical actuator	M	Collegamento circolatore Pump connection
D	Cappuccio di protezione Protective cap	N	Valvola di scarico Exhaust valve
E	Valvola di riempimento/valvola di sfiato Filling valve / venting valve	O	Detentore Lockshield
F	Valvola di non-ritorno Check valve	P	Valvola di intercettazione primario ritorno Return primary circuit shut-off valve
G	Collegamento circolatore Pump connection	Q	Acqua di ritorno al generatore Return water to generator
1-2-3	Collettori a barra Bar manifolds	R	Iniettore Injector

FUNZIONAMENTO

Il liquido (A) proviene dal generatore di calore e tramite valvola a sfera (B) entra nel collettore di TRITONE (1). Il liquido viene spinto dal circolatore del generatore di calore negli iniettori (R) che lo indirizzano agli anelli dei circuiti secondari o alle utenze in alta temperatura. Il liquido di ritorno degli anelli del circuito secondario entra nel collettore (3):

- se miscelato viene parzialmente richiamato dal circolatore della centralina (L) •
- se proveniente dagli anelli di alta temperatura (termoarredo o radiatori), viene richiamato dal circolatore del generatore di calore (Q) passando dalla valvola (P).

Il ritorno delle basse temperature transita dal gruppo valvola (M) richiamato dal circolatore(L), poi dal gruppo (G) dalla check valve (F) quindi entra nel collettore (2) che si miscelerà con il liquido in alta tramite gli iniettori (R) proveniente dal generatore di calore (A) ed entrerà nuovamente in circolo.

Il collettore di ritorno (3) può essere fornito con detentore a memoria meccanica (O) che è sempre in totale apertura, o con flussimetri (a richiesta) anch'essi in posizione di totale apertura massimo passaggio.

Completano la centralina la valvola di carico (E) su cui vi è posizionata una valvola di sfiato ed una valvola di scarico (N).

Il circolatore rispetta le normative ERP sul risparmio energetico.

FUNCTIONING

The liquid (A) comes from the heat generator and enters the TRITONE manifold (1) through the ball valve (B). The liquid is thrust by the pump of the heat generator into the injectors (R) that send it to the loops of the secondary circuits or to the high temperature utilities. The return liquid of the loops of the secondary circuit enters the manifold (3):

- if mixed it is partially recalled by the pump of the control unit (L)*
- if coming from the high temperature loops (heated towel rack or radiators), it is recalled by the pump of the heat generator (Q) passing through the valve (P).*

The high temperature return circuit must be positioned in the closest connection to the return in the heat generator (valve P). The low temperature return circuit transits from the valve unit (M) recalled by the pump (L), then from the unit (G) from the check valve (F) entering the manifold (2) where it mixes with the high temperature liquid through the injectors (R) coming from the heat generator (A) again entering in circulation.

The return manifold (3) can be supplied with mechanical memory lockshield (O) which is always fully open, or with flow meters (on demand) also in the fully open maximum flow position.

The control unit is completed by the filler valve (E) upon which a venting valve and an exhaust valve (N) are fitted. The circulator complies with the ERP regulations on energy saving.

CONFIGURAZIONE CONFIGURATION

STRUMENTAZIONE IN DOTAZIONE SUPPLIED INSTRUMENTS	
Barra in ottone da 1" e 1 1/4" 1" and 1 1/4" brass bar	CW603N
Vitone attacco M30x1.5 M30x1.5 connection spindle	CW617N Brass CW617N
Valvole di intercettazione attacco 3/4" Shutoff valves with 3/4" connection	CW617N Brass CW617N
Valvola di sfiato Venting valve	CW617N Brass CW617N
Derivazione da 2 a 12 vie 2 to 12 way shunt	Eurokono Eurocone
Iniettori Injectors	CW617N Brass CW617N
CIRCOLATORE PUMP	
Circolatore Pump	a portata variabile, Variable flow rate pump
risparmio energetico (ERP) energy-saving (ERP)	
Alimentazione Electric supply	230Vac/50Hz

STRUMENTAZIONE IN DOTAZIONE SUPPLIED INSTRUMENTS

Attacchi circolatore Pump connections	1"1/2 interasse 130mm 1"1/2 centre distance 130mm
Grado di protezione Protection class	IP44
VARIE MISCELLANEOUS	
Manopola Knob	ABS
Termometro Thermometer	0...80°C

STRUMENTAZIONE OPZIONALE OPTIONAL INSTRUMENTS

Adattatori Eurokono Euroconus Adapters	CW617N Brass CW617N
Flussimetro di ritorno Return flow meter	1 - 4 lt
Raccordo da 1" 1" fitting	CW617N Brass CW617N
Raccordo da 1" 1/4 1" 1/4 fitting	CW617N Brass CW617N
CASSETTA DRAWER	
Cassetta ad incasso Recessed drawer	Ferro verniciato, RAL 9010 Coated iron, RAL 9010
Staffe di supporto Support brackets	Ferro verniciato, RAL 9010 Coated iron, RAL 9010
Viteria Screws and bolts	Ferro zincato Galvanised iron
VARIE MISCELLANEOUS	
Termometri circuiti Circuit thermometers	4.8 x 1.2 cm
Testa elettro-termica Electrothermal head	230Vac a 4 fili 230Vac with 4 wires
Termostato ambiente Room thermostat	Cronotermostato-termostato ON/OFF, wireless ON/OFF, wireless chronothermostat-thermostat
Centralina Control unit	Modulo a 8 relé 230Vac 8 relay 230Vac module
Antenna	Antenna attiva Active antenna

REGOLAZIONE DELLA TEMPERATURA DEL LIQUIDO E DEI CIRCUITI SECONDARI

TRITONE è stato progettato in modo tale che ad ogni iniettore corrisponda un circuito di distribuzione secondario. Ogni iniettore viene regolato in modo indipendente dagli altri iniettori.

La regolazione della temperatura del liquido (bilanciamento del secondario) deve essere effettuata dopo il collegamento elettrico di testine elettrotecniche e dei termostati (o equivalenti).

TEMPERATURA DEL LIQUIDO DEL GENERATORE DI CALORE

Proponiamo due casi:

1. Ambienti con corpo scaldante ad alta temperatura (ad esempio termoarredo o radiatore) e bassa temperatura (ad esempio impianto a pavimento radiante).

La temperatura del liquido del circuito primario deve essere la stessa del corpo scaldante che richiede la temperatura più elevata.

2. Ambienti con corpo scaldante a bassa temperatura (ad esempio riscaldamento a pannelli radianti).

La temperatura del fluido del circuito primario deve essere almeno di 10°C superiore a quella del circuito secondario dell'ambiente più sfavorito, mai comunque inferiore a 40°C-45°C. Si consigliano i 50°C.

Secondo la norma UNI EN 1264-4:2009 (Sistemi radianti alimentati ad acqua per il riscaldamento e il raffrescamento integrati nelle strutture), è bene che sul pavimento si misurino temperature inferiori a 29°C, se non in rari casi nelle zone adiacenti alle pareti esterne o alle finestre.

REGOLAZIONE DELLA TEMPERATURA DEL LIQUIDO NEI CIRCUITI

Gli iniettori di TRITONE sono impostati con un set point di fabbrica. La temperatura del liquido degli anelli quindi varia in funzione della temperatura del liquido del generatore di calore.

E' possibile modificare la temperatura del liquido dei circuiti connessi a TRITONE in ogni momento e in modo semplice e veloce.

In particolare la temperatura di ogni anello può essere incrementata o diminuita semplicemente regolando gli iniettori, in funzione della necessità di progetto o di comfort.

Successivamente alla taratura dell'iniettore è necessario eseguire le opportune verifiche. La variazione di temperatura del circuito è verificabile in breve tempo con appositi strumenti (termometri a contatto).

TEMPERATURE ADJUSTMENT FOR SECONDARY LOOPS LIQUID

TRITONE was designed so that each injector corresponds to a secondary distribution loop. Each injector can be tuned independently from the others.

The adjustment of the liquid temperature (secondary balancing) must be carried out after the electrical connection of electrotemic heads and thermostats (or equivalent).

TEMPERATURE OF HEAT GENERATOR LIQUID

We propose two cases:

1. Environments with high temperature device (for example heated towel rack or radiator) and low temperature (for example radiant floor system).

The liquid temperature of the primary circuit must be the same as the device which requires high temperatures.

2. Environments with only low temperature device (for example radiating panel heating).

The temperature of the liquid of the high temperature flow (primary) must be at least 10° higher than the highest temperature requested by the system flow (secondary), anyhow never lower than 40-45 °C. We recommend 50 °C. According to standard UNI EN 1264-4:2009 (Water based surface embedded heating and cooling systems), the temperature of the floor should be lower than 29 °C, aside from rare cases in areas closed to the external walls or to windows.

ADJUSTMENT OF THE LIQUID TEMPERATURE IN THE LOOP

TRITONE injectors are tuned with the default setted points.

The liquid temperature of the loops therefore varies depending on the liquid temperature of the heat generator.

The liquid temperature of the loops connected to TRITONE can be modified at any time in a simply and quick way.

The temperature of each loop can be increased or decreased by simply adjusting the injectors according to the project or environment confort.

After calibrating the injector, the appropriate controls must be carried out. The temperature variation of the loop can be checked and tuned quickly with contact thermometers pointed on the secondary loops pipes.

OPERATIVITA' DELLA REGOLAZIONE DEL LIQUIDO DEI CIRCUITI SECONDARI OPERATION OF THE TUNING OF SECONDARY LOOPS LIQUID TEMPERATURE

La regolazione si esegue con una semplice chiave inglese da 11 mm con cui ruotare gli iniettori.

- La rotazione dell'iniettore in senso orario fa sì che la temperatura del circuito si alzi fino alla massima temperatura impostata nel generatore di calore.

- Ruotando la chiave inglese in senso antiorario si ottiene la temperatura desiderata, grazie alla miscelazione del liquido di mandata e del liquido di ritorno.

La verifica della temperatura del secondario si effettua misurando la temperatura sul tubo attraverso termometri a contatto.

Temperature is controlled by turning the injectors with a simple 11mm spanner.

- Turn the injector clockwise to raise the temperature of the circuit to the maximum temperature set in the heat generator

- Turn the injector anticlockwise to obtain the desired temperature by mixing of the delivery and return liquids.

Use contact thermometers to check the temperature.

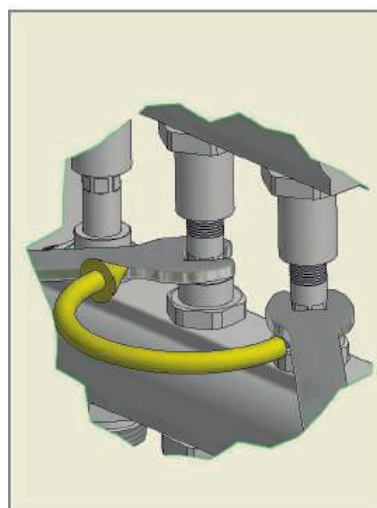

DEFINIZIONE DELLA PORTATA DELL'IMPIANTO

Poiché TRITONE è una centralina di miscelazione a portata costante e temperatura regolabile, per calcolare la portata dell'impianto e verificarne la corretta funzionalità è necessario impostare un semplice grafico in cui:

A. è il punto di intersezione tra il valore della temperatura di mandata dal generatore di calore (es. 50°C) e quello della portata complessiva del circuito come da progetto (es. 100l/h)

B. indica la temperatura media di ritorno visualizzabile sul termometro posto sopra il circolatore (es. 20°C)

C. è la temperatura di mandata del circuito secondario (nell'es. 27.5°C)

D. è la conseguente portata del circuito secondario che può essere calcolata dall'intersezione del valore di C con l'asse AB (nell'es. 25l/h)

Ad esempio quando la temperatura media di ritorno è di 30°C, la temperatura di mandata sarà di 35°C (punto E).

CALCULATION OF THE SYSTEM FLOW RATE

Since TRITONE is a mixing unit with constant flow and adjustable temperature, to calculate the flow rate of the system and verify its correct functionality it is necessary to set up a simple graph in which:

A. is the point of intersection between the value of the flow temperature from the heat generator (e.g. 50 °C) and that of the overall flow rate of the circuit as per project (e.g. 100l / h)

B. indicates the average return temperature that can be displayed on the thermometer placed above the circulator (e.g. 20 °C)

C. is the delivery temperature of the secondary circuit (in example 27.5 °C)

D. is the consequent flow rate of the secondary circuit that can be calculated from the intersection of the value of C with the AB axis (in example 25l / h)

For example, when the average return temperature is 30 °C, the flow temperature will be 35 °C (point E).

TESTE ELETTROTHERMICHE E ATTUATORI ELETTRO-MECCANICI

La testa elettrotermica è un attuatore elettro-meccanico che comanda l'apertura e la chiusura (ON/OFF) dell'otturatore meccanico di TRITONE.

General Fittings fornisce teste elettrotermiche con alimentazione 230Vac a 4 fili, con comando ausiliario per lo spegnimento della pompa.

ELECTROTHERMAL HEADS OR ELECTROMECHANICAL ACTUATORS

The electrothermal head is an electromechanical actuator which controls opening and closing (ON/OFF) of TRITONE's mechanical shutter.

General Fittings supplies electrothermal heads with 4-wire 230Vac power supply, with auxiliary control to switch off the pump.

MONTAGGIO TESTA ELETTRO-TERMICA ELECTROTHERMAL HEAD ASSEMBLY

Le teste General Fittings si montano su vitoni/otturatori termostatici dei collettori con filettatura M30x1.5.

La procedura per il montaggio sul collettore è la seguente:

- rimuovere il cappuccio di protezione
- posizionare la testa termostatica sul vitone/otturatore
- avvitare a mano la ghiera metallica
- eseguire i collegamenti elettrici secondo schema.

General Fittings heads are fitted on the thermostatic spindles/shutters of the manifolds with a M30x1.5 thread.

The installation procedure is as follows:

- remove the protective cap
- place the thermostatic head on the spindle/shutter
- screw the metal ring nut by hand
- perform the electrical connections as per diagram.

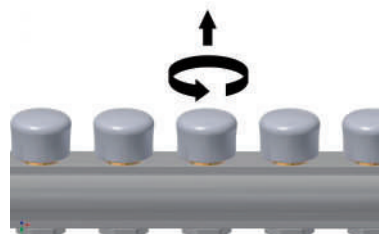

BILANCIAMENTO DEI CIRCUITI

Con TRITONE non serve bilanciare la portata dei circuiti, perché è una centralina a portata costante. È possibile invece regolare la temperatura di ogni singolo circuito. Sia che TRITONE sia fornito con memoria meccanica detentore sia con flussimetro sul ritorno del secondario, le regolazioni di questi non devono mai essere modificare salvo confronto preventivo con nostro ufficio tecnico. TRITONE è equipaggiato con detentori o flussimetri a richiesta in posizione di completa apertura.

BALANCING THE LOOPS

TRITONE does not require balancing the flow rate of the circuits, as it is a constant flow rate control unit. It is however possible to adjust the temperature of each individual circuit.

Whether TRITONE is supplied with mechanical lockshield memory or with flow meter on the return of the secondary circuit, their adjustments must never be modified without consulting our technical department.

TRITONE is equipped with lockshields or flow meters on demand at the complete opening position.

RIEMPIMENTO IMPIANTO

Il riempimento dell'impianto è un'operazione delicata che deve essere fatta da personale esperto.

L'obiettivo è di avere la minima quantità di aria all'interno delle tubazioni che in certe situazioni può determinare il malfunzionamento del sistema. Operativamente si procede in questo modo:

1. Chiudere sia la valvola a sfera di mandata (B) sia quella di ritorno (P).

FILLING THE SYSTEM

Filling the system is a delicate operation which must be performed by skilled personnel.

It is aimed having the minimum amount of air possible inside the pipes which in certain situations could determine malfunctioning.

Close both the entry flow ball valve (B) and the return flow ball valve (P).

2. Connect the liquid flow to the filler valve (E) applied to

2. Collegare il flusso del liquido alla valvola di riempimento (E) posizionata sul collettore (1).
3. Chiudere tutte le vie (D) del circuito poste sul collettore (1), tranne la prima più prossima alla valvola di riempimento (E): la chiusura avviene ruotando in senso orario i cappucci in plastica dati in dotazione e montati sui vitoni termostatici.
4. Chiudere tutti i detentori/flussimetri (O) posti sul collettore (3), tranne il corrispondente alla via lasciata aperta.
5. Aprire il flusso di acqua sulla valvola di riempimento (E).
6. Aprire valvola di scarico N posizionata sul collettore (3), assicurandosi della totale assenza di bolle d'aria.
7. Chiudere la valvola di scarico (N).
8. Chiudere la via appena riempita (D) e il corrispettivo detentore (O).
9. Aprire la via successiva a quella appena chiusa (D)

the manifold (1).

3. Close all the connections (D) of the loop on the manifold (1), except the first closest to the filler valve(E): it is closed by turning the supplied plastic caps mounted on the thermostatic spindles clockwise.
4. Close all the lockshields/flow meters (O) applied to the manifold (3), except the one on the connections left open
5. Open the water flow on the filler valve (E).
6. Open the exhaust valve N on the manifold (3), making sure there is absolutely no air.
7. Close the exhaust valve (N).
8. Close the connection just filled (D) and the respective lockshield (O).
9. Open the connection after the one just closed (D)

TIPO DI CASSETTA E POSIZIONAMENTO

TRITONE viene fornito in configurazione Basic abbinato alla sua cassetta (opzionale) dedicata di cui sotto sono riportate le dimensioni. Inoltre può essere anche utilizzato con cassette metalliche ad incasso di terze parti, di cui sono riportate le dimensioni di seguito.

TYPE OF CASE AND POSITIONING

TRITONE is supplied in basic configuration coupled to a case (optional), the size of which is indicated below. It can also be used with third-party recessed metal cases, with the size indicated below.

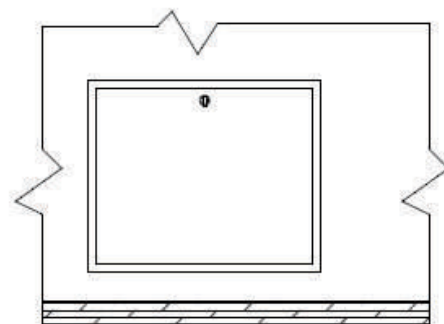
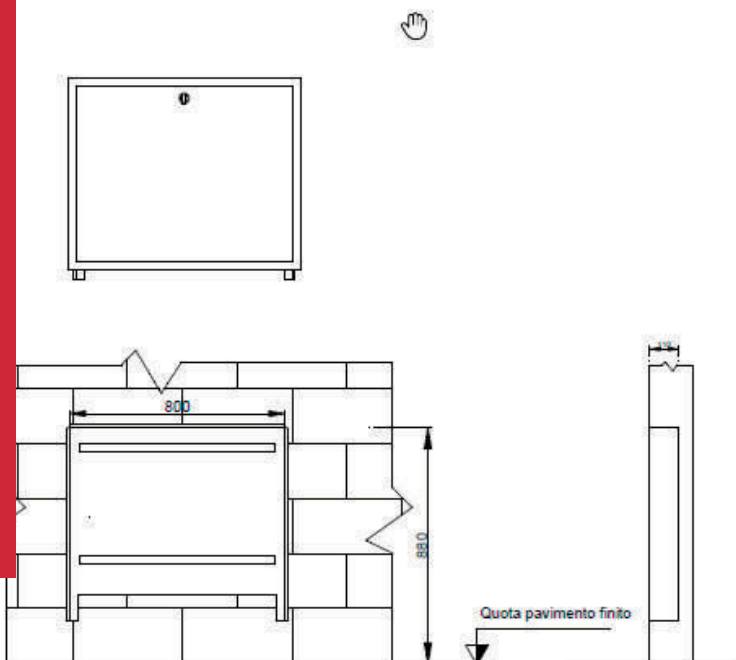



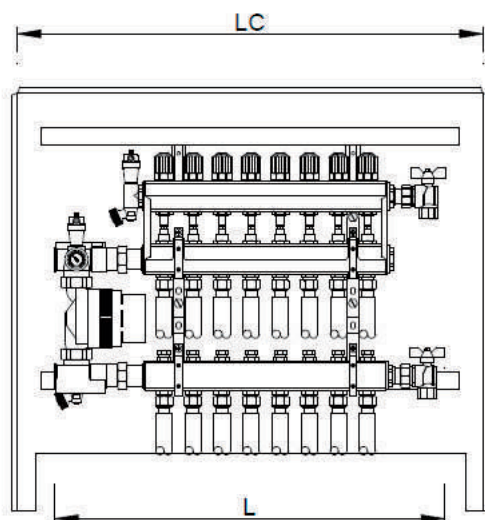





DIMENSIONI CASSETTA CASE DIMENSIONS



CENTRALINA DI MISCELAZIONE MIXING UNIT	L	LC
2 attacchi 2 connections	370 mm	720 x 700 mm
3 attacchi 3 connections	420 mm	720 x 700 mm
4 attacchi 4 connections	470 mm	720 x 700 mm
5 attacchi 5 connections	520 mm	720 x 700 mm
6 attacchi 6 connections	570 mm	720 x 700 mm
7 attacchi 7 connections	620 mm	720 x 700 mm
8 attacchi 8 connections	670 mm	720 x 900 mm
9 attacchi 9 connections	720 mm	720 x 900 mm
10 attacchi 10 connections	770 mm	720 x 900 mm
11 attacchi 11 connections	820 mm	720 x 1000 mm
12 attacchi 12 connections	870 mm	720 x 1000 mm
13 attacchi 12x3/8"x12	920 mm	720 x 1000 mm

CERTIFICAZIONI CERTIFICATIONS

STATO COUNTRY	CERTIFICAZIONE CERTIFICATION	STATO COUNTRY	CERTIFICAZIONE CERTIFICATION
			
			

ISTRUZIONI DI MONTAGGIO ASSEMBLY INSTRUCTIONS

1. Aprire la scatola

1. *Open the box*



2. Togliere la centralina di miscelazione TRITONE

2. *Remove the TRITONE mixing control unit.*



3. Installare la centralina nell'apposita cassetta, agganciandola prima sulle staffe in alto e successivamente su quelle in basso

3. *Install the control unit in the specific case, first releasing it from the top brackets and then from the bottom ones.*



4. Collegamento dei primari andata/ritorno dal generatore di calore

4. *Connection of entry/return flow primary circuits from heat generator.*



5. Collegamento e serraggio del secondario andata/ritorno dal sistema in bassa temperatura e alta temperatura

5. Connection and tightening of entry/return flow secondary circuit from high temperature and low temperature system.



6. Collegamento idraulico da cui effettuare il riempimento dell'impianto

6. Hydraulic connection from which to fill the system.

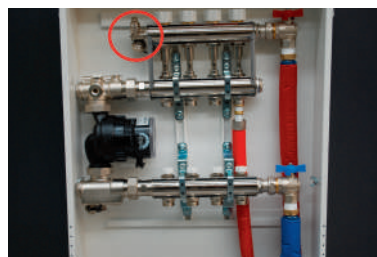

7. Riempimento impianto: chiudere le valvole di andata/ritorno del circuito primario (rossa e blu); apertura manuale del primo otturatore termostatico e ruotando in senso antiorario l'apposita manopola

7. Filling the system: close the entry/return valves of the primary circuit (red and blue); open manually the first thermostatic shutter and turn the specific knob anticlockwise.



LE OPERAZIONI DALLA 7 ALLA 10 SONO DA RIPETERE TANTE VOLTE QUANTE IL NUMERO DI VIE DELLA CONFIGURAZIONE TRITONE SCELTA.

STEPS 7-10 MUST BE REPEATED FOR AS MANY TRITONE CONFIGURATION CHOSEN CONNECTIONS.

8. Riempimento impianto: chiusura degli otturatori successivi ruotando in senso orario le apposite manopole

8. Filling the system: close the following shutters by turning the specific knobs clockwise.



9. Riempimento impianto: apertura del primo detentore ruotando la chiave a brugola in senso antiorario

9. Filling the system: open the first lockshield by turning the Allen wrench anticlockwise.



10. Riempimento impianto: chiusura dei successivi detentori ruotando la chiave a brugola in senso orario

10. Filling the system: close the following lockshields by turning the Allen wrench clockwise.



11. Collegamento elettrico

11. *Electrical connection.*

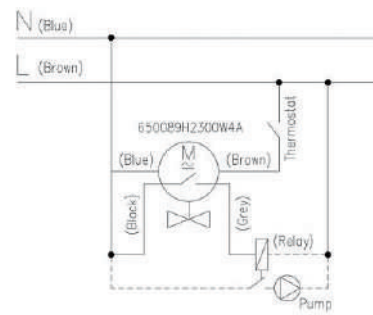

12. Regolazione della temperatura del liquido dei circuiti secondari con chiave inglese 11 mm.

12. *Liquid temperature adjustment of secondary circuits with 11 mm spanner.*



6500.E9 CENTRALINA DI MISCELAZIONE TRITONE CON VITONI A MEMORIA MECCANICA
MIXING CONTROL UNIT WITH MECHANICAL BALANCING SCREWS

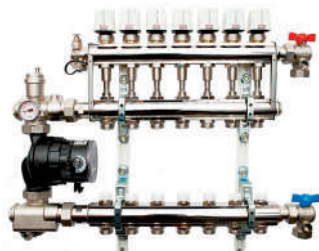

CODICE			
6500E9N100502A	1"	2	3/4" EK
6500E9N100503A	1"	3	3/4" EK
6500E9N100504A	1"	4	3/4" EK
6500E9N100505A	1"	5	3/4" EK
6500E9N100506A	1"	6	3/4" EK
6500E9N100507A	1"	7	3/4" EK
6500E9N100508A	1"	8	3/4" EK
6500E9N100509A	1"	9	3/4" EK
6500E9N100510A	1"	10	3/4" EK
6500E9N120511A	1"1/4	11	3/4" EK
6500E9N120512A	1"1/4	12	3/4" EK
6500E9N120513A	1"1/4	13	3/4" EK

6500.89 COMANDI ELETTROTHERMICI
ELECTROTHERMIC CONTROL



CODICE		
650089H2300W4A	230V 4 fili	50

Comando elettrotermico (nc) con 4 fili e 230v; grado di protezione IP54; temperatura ambiente di funzionamento 0-50°C; tempo d'intervento 3 min.

Electrothermic control (nc) with 4 wires and 230 V; grade of protection IP54; ambient working temperature 0-50°C; intervention time 3 min.

AC00.95 CIRCOLAT. LOWARA ECOCIRC BASIC 25-4/130
LOWARA PUMP ECOCIRC BASIC 25-4/130



CODICE	
AC0095L0254130	1"1/2

AC00.80.IT CASSETTA METALLICA PER CENTRALINA DI MISCELAZIONE-completo di kit di fissaggio
MIXING UNIT METAL CABINET-fixing kit included



CODICE	Ø	
AC0080ITR0700H	L=700mm H=720mm P=110mm	2-3-4-5-6-7
AC0080ITR0900H	L=900mm H=720mm P=110mm	8-9-10
AC0080ITR1000H	L=1000mm H=720mm P=110mm	11-12-13

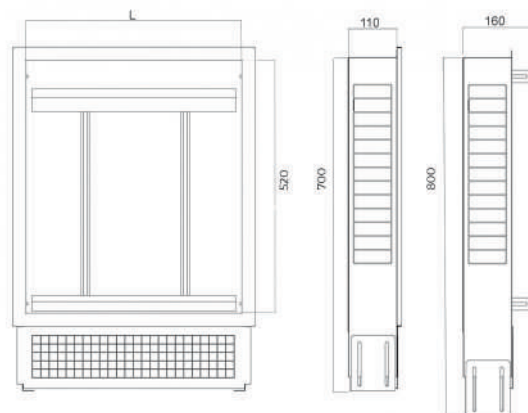

AC00.80.IT.RM KIT FISSAGGIO (COMPRESO DI DADI E VITI)
MIXING UNIT METAL CABINET-fixing kit included



CODICE

AC0080ITRM808H

6500.35.SO TERMOMETRO CON SONDA A CONTATTO
THERMOMETER WITH CONTACT PROBE



CODICE

650035HSOTERMV

$-50^{\circ}\text{C} \div +130^{\circ}\text{C}$

6500.35.SI TERMOSTATO DI SICUREZZA
SAFETY THERMOSTAT



CODICE

650035HSITERMV

6500.35.AD STRISCIA ADESIVA TERMOMETRICA
STICKER THERMOMETER

20

CODICE

650035HADTERMH

\emptyset

$+32^{\circ}\text{C} \div +42^{\circ}\text{C}$

3400.15 RACCORDO DIRITTO EUROCONO CON GIRELLO
STRAIGHT FITTING WITH LOOSE NUT AND
EUROCONE CONNECTION



CODICE

340015H051622A

\pm

2.2

\emptyset

3/4"x16

\diamond

10

\square

100

340015H052028A

2.8

3/4"x20

10

100

5S00.15.N

RACCORDO DIRITTO SEDE CONICA O-RING
NICHELATO CON GIRELLO-EUROCONO
*NICKEL-PLATED STRAIGHT FITTING WITH LOOSE
NUT AND EUROCONE*



CODICE	+	Ø	◇	☐
5S0015N051620T	2.0	3/4" EKx16	10	100
5S0015N051820T	2.0	3/4" EKx18	10	100
5S0015N052020T	2.0	3/4" EKx20	10	80
5S0015N052022T	2.25	3/4" EKx20	10	80

5T00.15.N

RACCORDO DIRITTO NICHELATO SEDE CONICA O-
RING CON GIRELLO
*NICKEL PLATED STRAIGHT FITTING WITH LOOSE NUT
AND CONICAL CONNECTION*



CODICE	+	Ø	◇	☐
5T0015N041620T	2.0	1/2"x16	10	100
5T0015N042020T	2.0	1/2"x20	10	100
5T0015N051620T	2.0	3/4"EK.x16	10	100
5T0015N052020T	2.0	3/4"EK.x20	10	80

5700.80

DADO NICHELATO, OGIVA E INSERTO EUROCONO
PER TUBO MULTISTRATO
*NICKEL-PLATED NUT, OLIVE AND INSERT EUROCONE
FOR MULTILAYER PIPE*



CODICE	+	Ø	◇	☐
570080N051216A	1.6	3/4" EKx12	10	100
570080N051620A	2.0	3/4" EKx16	10	100
570080N051622A	2.25	3/4" EKx16	10	100
570080N051720A	2.0	3/4" EKx17	10	100
570080N051820A	2.0	3/4" EKx18	10	100
570080N052020A	2.0	3/4" EKx20	10	100
570080N052022A	2.25	3/4" EKx20	10	100
570080N052025A	2.5	3/4" EKx20	10	100

3300.80 DADO NICHELATO, OGIVA E INSERTO EUROCONO
PER TUBO PE-X
NICKEL-PLATED NUT, OLIVE AND INSERT EUROCONO
FOR PE-X PIPE



CODICE	+	Ø	◇	☐
330080N051013A	1.3	3/4" EKx10	10	150
330080N051420A	2.0	3/4" EKx14	10	100
330080N051615A	1.5	3/4" EKx16	10	100
330080N051618A	1.8	3/4" EKx16	10	100
330080N051620A	2.0	3/4" EKx16	10	100
330080N051622A	2.2	3/4" EKx16	10	100
330080N051720A	2.0	3/4" EKx17	10	100
330080N051820A	2.0	3/4" EKx18	10	100
330080N051825A	2.5	3/4" EKx18	10	100
330080N052020A	1.9-2.0	3/4" EKx20	10	100
330080N052028A	2.8	3/4" EKx20	10	100

6300.80 DADO NICHELATO, OGIVA E INSERTO EUROCONO
NICKEL-PLATED NUT, OLIVE AND INSERT
EUROCONO



CODICE	+	i	Ø	◇	☐
630080N051618A	1.8	per tubo multistrato	3/4" EKx16	10	100
630080N051618A	1.8	per tubo multistrato	3/4" EKx16	10	100
630080N051620A	2.0	per tubo multistrato	3/4" EKx16	10	100
630080N051720A	2.0	per tubo Pe-x	3/4" EKx17	10	100
630080N051820A	2.0	per tubo multistrato	3/4" EKx18	10	100
630080N052020A	2.0	per tubo multistrato	3/4" EKx20	10	100

6300.80NX DADO NICHELATO, OGIVA E INSERTO EUROCONO
NICKEL-PLATED NUT, OLIVE AND INSERT
EUROCONO



CODICE	+	i	Ø	◇	☐
630080NX51626A	2.6	Pex Al Pex 16x2.6	3/4" EKx16	10	100
630080NX52029A	2.9	Pex Al Pex 20x2.9 / Pex 20x2.8	3/4" EKx20	10	100

6300.85 ADATTATORE SEDE PIANA EUROCONO
EUROCONO FLAT SEAL ADAPTER



CODICE	○	◇	☐
630085H050000H	3/4"	10	500



HOLLER

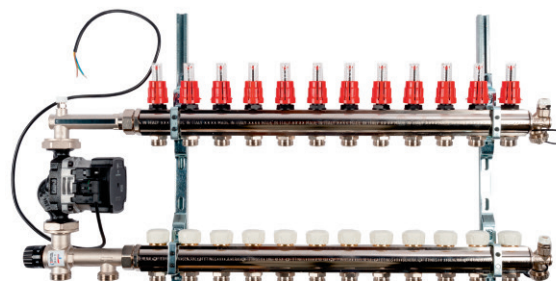

Gruppi di miscelazione a punto fisso

Fixed point thermostatic regulation mixing and distribution unit

Gruppo preassemblato per la regolazione e circolazione di fluido miscelato a punto fisso. Permette la circolazione del fluido termovettore, proveniente dal circuito primario, ed il mantenimento costante della temperatura impostata (punto fisso) tramite l'ausilio di una valvola miscelatrice ad elemento termostatico.

Trova impiego in impianti di riscaldamento in generale e impianti a pannelli radianti.

Il gruppo è composto da circolatore, valvola miscelatrice termostatica, termometri di mandata a cristalli liquidi, valvola di sfogo aria manuale, raccordi per collettori di distribuzione. Il gruppo è installabile con i collettori di distribuzione a destra o a sinistra.

Pre-assembled pump group for fixed point regulation and circulation of mixed fluid. It allows the circulation of the thermal fluid, coming from the primary circuit, by keeping the temperature at a pre-set value (fixed point) through the help of a mixing valve with thermostatic element.

It is used in heating systems in general and radiant panel systems.

The group is composed of a pump, thermostatic mixing valve, flow LCD thermometers, manual air vent, fittings for secondary distribution manifolds. The group can be installed with the secondary distribution manifolds on the right or the left.



VANTAGGI

- Reversibilità: grazie alla presenza di un termometro anche sul lato posteriore, il gruppo è facilmente invertibile da destra a sinistra semplicemente ribaltandolo completamente.
- Flessibilità d'installazione. Il gruppo può essere installato a muro, cassetta o nicchia.
- Struttura in monoblocco. La miscelatrice termostatica ed il raccordo che ospita i termometri e lo sfogo aria sono realizzati in monoblocco. L'installazione risulta immediata e si minimizzano i punti di possibile perdita idraulica.
- Dispositivo antimanomissione. Il dispositivo, posizionato all'interno della manopola della valvola miscelatrice, evita variazioni indesiderate della taratura.
- Raccordi rapidi. I raccordi per i collettori sono dotati di O-ring e guarnizione piana al fine di velocizzare l'installazione ed evitare l'utilizzo di altri elementi di tenuta come canapa o teflon.
- Raccordo portastrumenti. Equipaggiato di sfogo aria manuale e doppio termometro LCD fronte/retro per controllare la temperatura dell'acqua miscelata inviata all'impianto.
- Installazione compatta: l'interasse degli attacchi lato primario da 75mm, degli attacchi al collettore secondario con interasse 211mm e la pompa da 130mm rendono molto compatta l'installazione.

ADVANTAGES

- *Reversibility: thanks to the presence of a thermometer also on the rear side, the group can be easily inverted from right to left by fully reversing it.*
- *Flexibility of installation. The group can be installed on wall, in box or recessed.*
- *Monobloc structure. The thermostatic mixing valve and the instrument holder fitting, equipped with air vent and thermometers, are designed as monobloc structure. The installation is therefore immediate and points of possible leakage are reduced to a minimum.*
- *Anti-tamper device. The device, placed within the mixing valve knob, avoids undesired variations of the setting.*
- *Fast fittings. The provided fittings are equipped with O-Ring and flat gasket to make the installation faster, avoiding the use of other sealing systems like hemp or teflon tapes.*
- *Instrument holder fitting. Equipped with manual air vent, double LCD thermometer (on front and rear side) to check the temperature of the mixed water supplied to the system.*
- *Compact installation: the 75 mm centre distance of the primary side, the 211 mm centre distance to the secondary manifold and the 130 mm pump make the installation very compact.*

CAMPI DI APPLICAZIONI FIELDS OF APPLICATION

APPLICAZIONI APPLICATIONS		T. max	Press.max Max. pressure
 riscaldamento a pavimento low temperature heating (floor)		5-90°C	10 bar
 riscaldamento a parete low temperature heating (wall)		5-90°C	10 bar
 riscaldamento a soffitto low temperature heating (ceiling)		5-90°C	10 bar

PRESTAZIONI PERFORMANCE

PRESTAZIONI PERFORMANCE

Campo di temperatura Working temperature range	5-90°C
Pressione massima di esercizio Maximum working pressure	10 bar
Attacchi filettati maschio Male threaded connections	ISO 228-1
Interasse attacchi lato primario Centre distance on the primary manifold	75 mm
Interasse attacchi al collettore secondario Connection centre distance to secondary manifold	211 mm
Pompa Pump	Grundfos UPM3 AUTO 25-70 130
Fluidi compatibili Suitable fluids	acqua, soluzioni glicolate (max 30%) water, glycol solutions (max 30%)
Campo di regolazione temperatura Temperature adjustment range	20-55°C
Precisione Accuracy	±2 °C
Taratura di fabbrica Factory setting	40°C
Scala termometri a cristalli liquidi LCD thermometer scale	24-48°C
Coefficiente di flusso riferito alla sola valvola miscelatrice Flow coefficient of the mixing valve only	3,5 Kv

COMPONENTI COMPONENTS

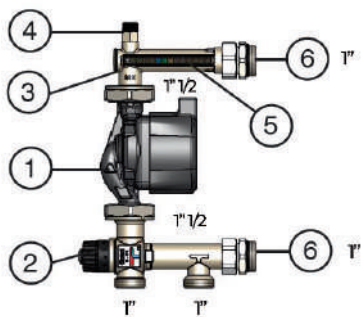

COMPONENTI COMPONENTS

1	Pompa Pump
2	Valvola miscelatrice termostatica Thermostatic mixing valve
3	Raccordo porta strumenti Instrument holder fitting
4	Valvola di sfogo aria manuale Manual air vent
5	Termometro a cristalli liquidi LCD thermometer
6	Raccordi per collettore secondario Fittings for secondary manifold

MATERIALI MATERIALS

MATERIALI MATERIALS	
Raccordo portastrumenti Instrument holder fitting	ottone EN 12165 CW617N brass EN 12165 CW617N
RACCORDI AL COLLETTORE SECONDARIO FITTINGS FOR SECONDARY MANIFOLD	
Corpo Body	ottone EN 12164 CW617N brass EN 12164 CW617N
Guarnizione Gasket	EPDM
Termometri Thermometers	crystalli liquidi liquid crystals (LCD)
VALVOLA MISCELATRICE TERMOSTATICA THERMOSTATIC MIXING VALVE	
Corpo Body	ottone EN 12165 CW617N brass EN 12165 CW617N
Guarnizioni Gaskets	EPDM
Vitone Headwork	ottone EN 12164 CW617N brass EN 12164 CW617N
Molla Spring	acciaio inox AISI 302 stainless steel AISI 302
Sensore termostatico Thermostatic sensor	cera wax
Manopola Knob	ABS
POMPA PUMP	
Corpo Body	ghisa cast iron
Alimentazione Electric supply	230 V-50/60 Hz
Grado di protezione Protection class	Grundfos UPM3: IP 44
Interasse Centre distance	130 mm
Attacchi Connections	G 1 1/2 M (ISO 228-1)
Guarnizioni Gaskets	EPDM

INSTALLAZIONE

Le possibili installazioni del gruppo sono:

- installazione a parete
- installazione in nicchie
- installazione in cassetta

INSTALLATION

The mounting options of the group are:

- *Wall installation*
- *Recessed installation*
- *Box installation*

Il gruppo può essere collegato direttamente ad un generatore, se questo è privo di pompa. Se invece il generatore è dotato di pompa, si interpone un separatore idraulico tra il gruppo ed il generatore per evitare reciproche influenze tra le pompe. Il gruppo può essere installato a valle di un accumulo inerziale, che svolge quindi la funzione di separatore idraulico.

The group can be directly connected to a generator if the latter is not equipped with a pump. Instead, if the generator is equipped with a pump, an hydraulic separator should be placed between the generator and the group, in order to avoid mutual influences between the pumps. The group can be installed downstream of an inertial water storage, which performs the function of an hydraulic separator.

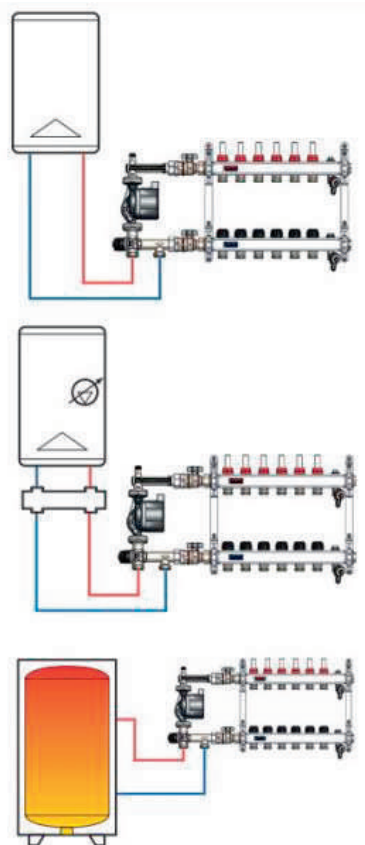

INSTALLAZIONE: INFORMAZIONI GENERALI

Il montaggio e lo smontaggio deve essere eseguito ad impianto freddo e non in pressione.
 Accessibilità: non ostacolare l'accesso e la visibilità del dispositivo per permettere operazioni di verifica e manutenzione al dispositivo o al resto della componentistica.

INSTALLATION: GENERAL INFORMATION

*Assembling and disassembling is to be performed with system cold and without pressure.
 Accessibility: do not obstruct the access and visibility to the device in order to allow check and maintenance operations to the device or other components.*

POSIZIONAMENTO DEL GRUPPO GROUP POSITION

Il gruppo può essere installato come in figura, con asse di rotazione della pompa sempre in orizzontale.

Posizione a ore 12: consigliata.

Posizione a ore 3: consentita solo se il collettore secondario (collegato direttamente al gruppo) è privo di flussimetri oppure è in posizione remota (dal gruppo partono solo le tubazioni di mandata e ritorno impianto).

Posizione a ore 6: consentita ma la valvola di sfogo aria non può essere più usata in quanto si trova capovolta.

Posizione a ore 9: v. ore 3.

In ogni caso, occorre provvedere ad un opportuno staffaggio del gruppo.

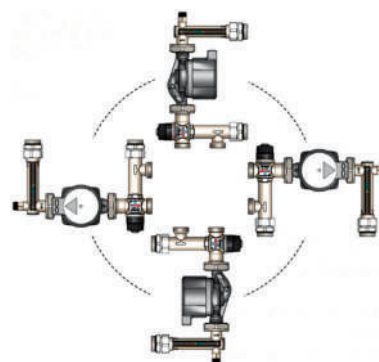

The group can be installed in one of the ways shown in the picture, with the pump rotation axis always horizontal.

12 o'clock position: suggested.

3 o'clock position: allowed only if the secondary manifold (directly connected to the group) is not equipped with flow meters or it is placed in remote position (only system flow and return pipes are directly connected to the group).

6 o'clock position: allowed but the manual air vent cannot be used anymore since it is placed upside down.

9 o'clock position: see 3 o'clock.

In any case, suitable brackets should be used to fix the group.

REVERSIBILITA' DEL GRUPPO GROUP REVERSIBILITY

Le calotte vengono fornite allentate per consentire la rotazione della pompa in cantiere. Avvitare le calotte a tenuta prima di installare il gruppo.

Il gruppo è immediatamente collegabile ad un collettore secondario alla propria destra o alla propria sinistra. A tale scopo, non sono richieste operazioni particolari.

Grazie alla presenza di un termometro a cristalli liquidi anche sulla parte posteriore, il gruppo può essere completamente e velocemente ribaltato per avvitare un collettore di distribuzione alla propria sinistra.

Serrare a fondo le calotte prima di procedere con l'installazione.

The nuts are supplied loosened to facilitate the pump rotation on the installation field. Fully screw the nuts before installing the group.

The group can be immediately connected to a secondary distribution manifold on its right or left side. To do this, no specific operation is requested.

Thanks to the presence of a LCD thermometer also on the rear part, the group can be fully and quickly overturned to screw a distribution manifold on its left side.

Fully screw the nuts before proceeding with the installation.

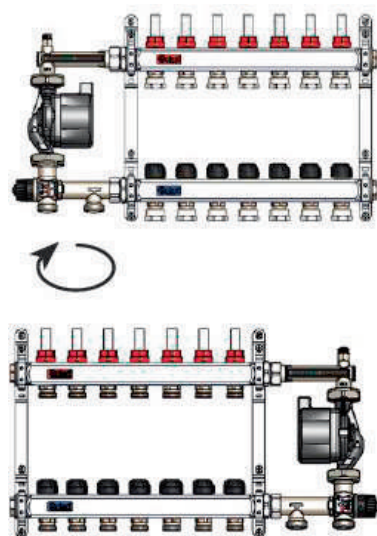

Collegamento al collettore secondario

Connection to the secondary manifold.

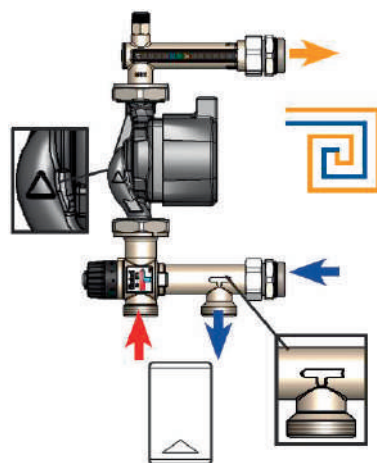

I raccordi per collettore secondario sono dotati di un O-Ring.

The fittings for the secondary manifold are equipped with O-Ring.

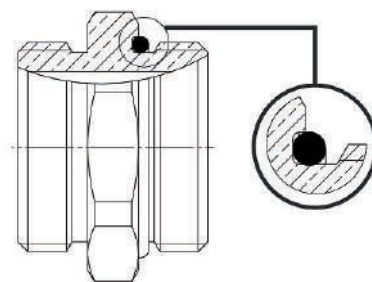

Avvitare i raccordi al collettore secondario usando la parte filettata con O-Ring.

Screw the fittings to the secondary manifold using the threaded part with O-Ring.

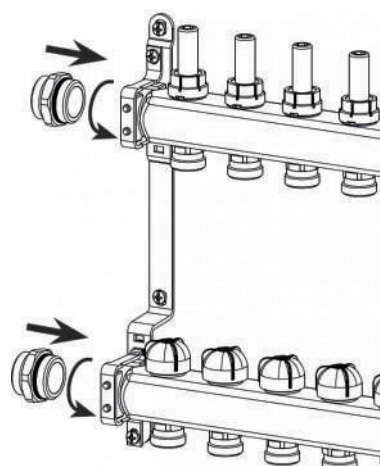

Avvitare l'altra estremità dei raccordi al gruppo di regolazione, utilizzando le calotte girevoli con guarnizione piana fornite in confezione.

Screw the other side of the fittings to the regulating group, using the running nuts with flat gasket supplied in the package.

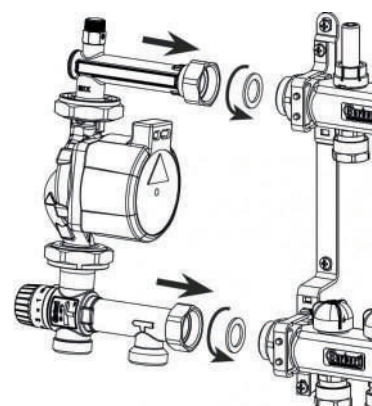

IMPOSTAZIONE DELLA VALVOLA MISCELATRICE ADJUSTMENT OF THE THERMOSTATIC MIXING VALVE

La valvola miscelatrice termostatica mantiene costante la temperatura dell'acqua inviata all'impianto. La regolazione a punto fisso si ottiene tramite un sensore termostatico che si muove grazie alla dilatazione termica della cera contenuta al suo interno. Il sensore termostatico integrato nella valvola permette maggiore precisione ed affidabilità rispetto alle termostatiche con tubo capillare esterno.

The thermostatic mixing valve keeps constant the temperature of the water supplied to the system. The fixed point regulation is achieved through a thermostatic sensor which moves thanks to the expansion of the wax inside of it. The sensor integrated within the valve is more precise and reliable than the thermostatic valves with external capillary.

La manopola dispone di un sistema antimanomissione che ne rende difficile la rotazione, impedendo variazioni involontarie della taratura. Il sistema è disattivabile allentando lievemente la vite di bloccaggio.

The knob is equipped with an anti-tamper mechanism which makes the rotation difficult, thus avoiding undesired set changes. The mechanism can be released with a screwdriver, slightly loosening the locking screw.

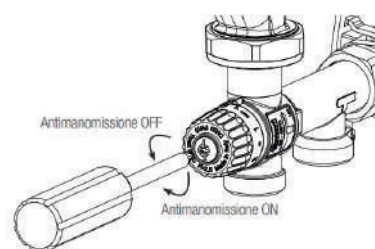
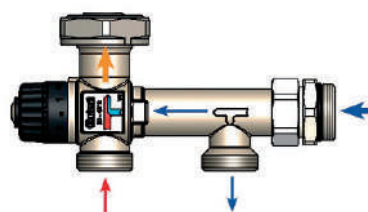

PRIMO AVVIAMENTO DELL'IMPIANTO

La temperatura di miscelazione a punto fisso può essere impostata con la manopola prima di installare il gruppo oppure, dopo averlo installato, esclusivamente ad IMPIANTO FREDDO. Per impostare una temperatura diversa dalla taratura di fabbrica, procedere come segue:

FIRST SYSTEM START UP

The fixed point temperature value can be set with the knob before installing the group or, after the installation, exclusively with the SYSTEM COLD. To set a temperature value different from the factory one, proceed as follows:

1. La scala numerica sulla manopola della valvola corrisponde ai valori di temperatura indicati nella tabella.

1. The graduated scale on the knob corresponds to the temperature values shown in the table.

	20-55°C
	°C
Min	20°C
1	28°C
2	35°C
3	41°C
4	47°C
5	51°C
Max	55°C
	MIN

2. Con un cacciavite allentare lievemente la vite di bloccaggio, tenendo ferma la manopola con la mano.

2. With a screwdriver, slightly loosen the locking screw, holding the knob with your hand.

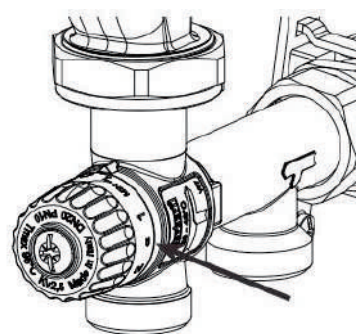

3. Impostare un valore di temperatura dell'acqua miscelata lievemente inferiore al valore di progetto. Attivare il generatore ed attendere che raggiunga la temperatura di esercizio di progetto (superiore al set della valvola). Attivare la pompa del gruppo. Attendere lo stabilizzarsi della temperatura di miscelazione controllando il termometro di mandata.

3. Set a mixed water temperature value slightly lower than the design temperature. Activate the generator and wait until it reaches its design working temperature (higher than the valve setting). Activate the group pump. Wait until the mixed water temperature gets stable. Read its value on the flow temperature gauge.

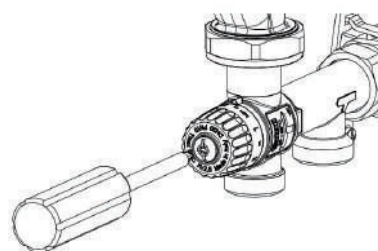

4. Ruotare lentamente a step la manopola in senso antiorario verso temperature crescenti e attendere sempre lo stabilizzarsi della temperatura controllandola sul termometro di mandata. Procedere fino a raggiungere la temperatura di mandata dell'acqua miscelata come indicato sul progetto.

4. Counterclockwise rotate step by step the knob to increase the temperature. Then wait until the temperature gets stable. Read its value on the flow temperature gauge. Proceed in the same way until the design flow temperature is reached.

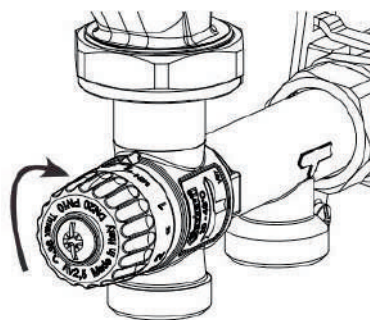

5. Al raggiungimento della temperatura desiderata, chiudere la vite di bloccaggio tenendo la manopola con la mano.

5. When the desired temperature is reached, close the locking screw, holding the knob with your hand.

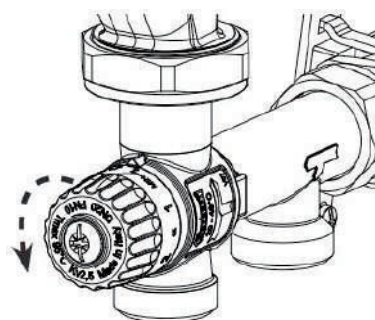

IMPOSTAZIONE SUCCESSIVA

Se in un momento successivo fosse necessario modificare il set della valvola, procedere come segue.
 Caso 1: temperatura inferiore alla taratura attuale. Lasciare raffreddare l'impianto almeno fino ad avere una temperatura di ritorno inferiore al nuovo set da impostare sulla valvola. Seguire i punti 1, 2, 3, 4 e 5.
 Caso 2: temperatura superiore alla taratura attuale. In questo caso la regolazione può essere effettuata ad impianto già attivo, oltre che ad impianto freddo. Seguire i punti 1, 2, 4 e 5.

NEXT SETTING

If later a change should be needed in the valve setting, proceed as follows.
 Case 1: temperature lower than the current setting. Let the system get cold to obtain at least a return temperature lower than the new valve setting. Follow points 1, 2, 3, 4 and 5.
 Case 2: temperature higher than the current setting. In this case, the setting can be carried out also with the system running as well as with the system cold. Follow points 1, 2, 4 and 5.

VALVOLA DI SFOGO ARIA

Utilizzo: la valvola di sfogo aria manuale può essere usata in fase di caricamento impianto oppure per evacuare eventuali accumuli di aria che si possono formare durante il normale funzionamento dell'impianto. Si consiglia di agire sulla valvola ad impianto freddo.

MANUAL AIR VENT

Use: the manual air vent can be used during system filling or to release air accumulated during normal functioning of the system. It is suggested to operate on the valve when the system is cold.

6500.Q1GRUPPO DI MISCELAZIONE A PUNTO FISSO
FIXED POINT MIXING UNIT

CODICE			
6500Q1N100502A	2	1"	211
6500Q1N100503A	3	1"	211
6500Q1N100504A	4	1"	211
6500Q1N100505A	5	1"	211
6500Q1N100506A	6	1"	211
6500Q1N100507A	7	1"	211
6500Q1N100508A	8	1"	211
6500Q1N100509A	9	1"	211
6500Q1N100510A	10	1"	211
6500Q1N100511A	11	1"	211
6500Q1N100512A	12	1"	211

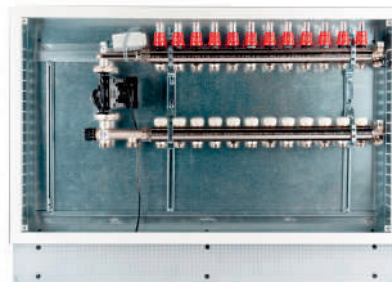

6500.Q2GRUPPO DI MISCELAZIONE A PUNTO FISSO IN
CASSETTA CON TERMOSTATO DI SICUREZZA
FIXED POINT MIXING UNIT IN BOX WITH SAFETY
THERMOSTAT

CODICE			
6500Q2N100502A	2	1"	211
6500Q2N100503A	3	1"	211
6500Q2N100504A	4	1"	211
6500Q2N100505A	5	1"	211
6500Q2N100506A	6	1"	211
6500Q2N100507A	7	1"	211
6500Q2N100508A	8	1"	211
6500Q2N100509A	9	1"	211
6500Q2N100510A	10	1"	211
6500Q2N100511A	11	1"	211
6500Q2N100512A	12	1"	211

6500.Q3

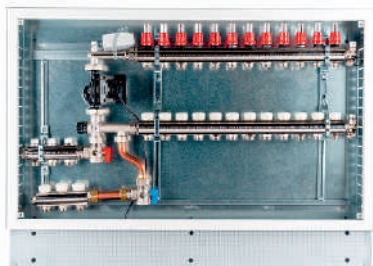
GRUPPO DI MISCELAZIONE A PUNTO FISSO IN CASSETTA CON TERMOSTATO DI SICUREZZA E KIT ALTA TEMPERATURA A 2 VIE
 FIXED POINT MIXING UNIT IN BOX WITH SAFETY THERMOSTAT AND 2-WAY HIGH TEMPERATURE KIT





CODICE			
6500Q3N100502A	2	1"	211
6500Q3N100503A	3	1"	211
6500Q3N100504A	4	1"	211
6500Q3N100505A	5	1"	211
6500Q3N100506A	6	1"	211
6500Q3N100507A	7	1"	211
6500Q3N100508A	8	1"	211
6500Q3N100509A	9	1"	211
6500Q3N100510A	10	1"	211
6500Q3N100511A	11	1"	211
6500Q3N100512A	12	1"	211

6500.Q4

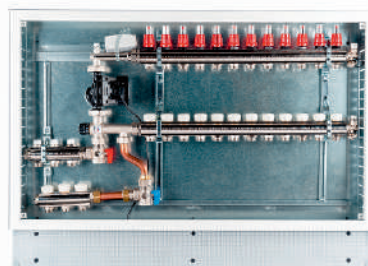
GRUPPO DI MISCELAZIONE A PUNTO FISSO IN CASSETTA CON TERMOSTATO DI SICUREZZA E KIT ALTA TEMPERATURA A 3 VIE
 FIXED POINT MIXING UNIT IN BOX WITH SAFETY THERMOSTAT AND 3-WAY HIGH TEMPERATURE KIT





CODICE			
6500Q4N100502A	2	1"	211
6500Q4N100503A	3	1"	211
6500Q4N100504A	4	1"	211
6500Q4N100505A	5	1"	211
6500Q4N100506A	6	1"	211
6500Q4N100507A	7	1"	211
6500Q4N100508A	8	1"	211
6500Q4N100509A	9	1"	211
6500Q4N100510A	10	1"	211
6500Q4N100511A	11	1"	211
6500Q4N100512A	12	1"	211

6500.Q5

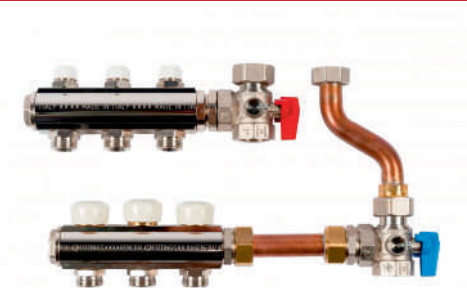
KIT PER LA DISTRIBUZIONE AD ALTA TEMPERATURA
 HIGH TEMPERATURE KIT



CODICE			
6500Q5N100502A	3/4" EK	2	1"
6500Q5N100503A	3/4" EK	3	1"

6500.35.SI TERMOSTATO DI SICUREZZA
SAFETY THERMOSTAT



CODICE

650035HSITERMH

6500.P4 GRUPPO DI MISCELAZIONE CON CIRCOLATORE
CONTROL PACK WITH PUMP



CODICE

6500P4N10211AH



i



Kv 3.5

211

6500P4N10200AH

200-211

Kv 3.5

Campo di regolazione temperatura: 20-25°C; Temperatura massima di esercizio: 90°C; Pressione massima di esercizio: 10 bar; Pompa: Grundfos UPM3:IP 44; Coefficiente di flusso riferito alla sola valvola miscelatrice: 3,5 Kv

Temperature adjustment range: 20-25°C; Max working temperature: 90°C; Max working pressure: 10 bar; Pump: Grundfos UPM3:IP 44; Flow coefficient of the mixing valve only: 3,5 Kv.

6500.P8 GRUPPO DI MISCELAZIONE SENZA CIRCOLATORE
CONTROL PACK WITHOUT PUMP



CODICE

i



6500P8N102110H

5

6500P8N102000H

eccentrico

5

Campo di regolazione temperatura: 20-55°C; Temperatura massima di esercizio: 90°C; Pressione massima di esercizio: 10 bar; Coefficiente di flusso riferito alla sola valvola miscelatrice: 3,5 Kv

Temperature adjustment range: 20-55°C; Maximum working temperature: 90°C; Maximum working pressure: 10 bar; Flow coefficient of mixing valve only: 3.5 Kv

AC00.80.IT CASSETTA METALLICA PER CENTRALINA DI
MISCELAZIONE-completo di kit di fissaggio
MIXING UNIT METAL CABINET-fixing kit included



CODICE

Ø



AC0080ITR0700H

L=700mm H=720mm P=110mm

2-3-4-5-6-7

AC0080ITR0900H

L=900mm H=720mm P=110mm

8-9-10

AC0080ITR1000H

L=1000mm H=720mm P=110mm

11-12-13

THOR

SERIE 6A00

LINE 6A00

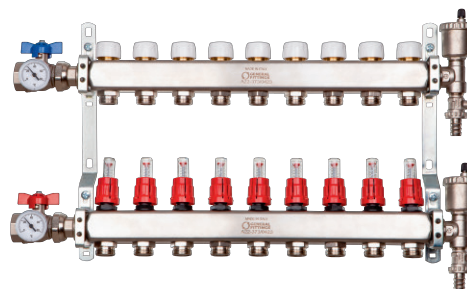

Collettori di distribuzione in acciaio inox Stainless steel distribution manifolds

I collettori THOR (SERIE 6A00) con uscite da 3/4" Eurocono sono la soluzione ideale per la distribuzione di acqua in impianti di riscaldamento e raffrescamento radiante.

I collettori sono premontati su staffe e sono disponibili con barre di mandata e ritorno da 1", possono essere alloggiati in cassette di metallo e posizionati nelle pareti divisorie.

Numerosi accessori permettono di completare il collettore con tutti i componenti necessari al funzionamento dell'impianto: valvole a sfera di intercettazione, valvole di sfiato, valvole by pass, rubinetti di carico-scarico.

THOR (6A00 SERIES) manifolds with 3/4" Eurocone outlets are the ideal solution for the distribution of water in radiant heating and cooling systems.

These manifolds are pre-assembled on brackets and are available with 1" delivery and return flow rods. They can be housed in metal cases and placed within partition walls.

A wide range of accessories makes it possible to complete the manifold with all the necessary components for the proper functioning of the system: shut-off ball valves, venting valves, bypass valves and input/output taps.







VANTAGGI

- Bilanciamento di ogni derivazione
- No ad inutili sprechi
- Elevato comfort tecnico
- Utilizzabili in impianti sia a bassa che ad alta temperatura
- Resistenza meccanica
- Elevata leggerezza
- Nessuna tensocorrosione
- Nessuna corrosione elettrolitica
- Elevata portata

ADVANTAGES

- *Balancing of each loop*
- *No unnecessary waste*
- *High technical comfort*
- *Suitable both for high and low temperature installations*
- *Mechanical resistance*
- *High lightness*
- *No tension corrosion*
- *No electrolytic corrosion*
- *High flow rate*

APPLICAZIONI E PRESTAZIONI FIELDS OF APPLICATION

APPLICAZIONI APPLICATIONS	T. min. con vitone T.min. with control stem	T. min. con flussimetro T.min. with flow meter	T. max con vitone T.max with control stem	T. max con flussimetro T.max with flow meter	Press. max con vitone Press. max with mechanical screw	Press. max con flussimetro Press. max with flow meter	Portata con flussimetro Flow rate with flow meter
 riscaldamento a pavimento floor heating	-20°C	-7°C	+95°C	+65°C	10 bar	6 bar	0.5 lt/min
 riscaldamento a parete low temperature heating (wall)	-20°C	-7°C	+95°C	+65°C	10 bar	6 bar	0.5 lt/min
 riscaldamento a soffitto low temperature heating (ceiling)	-20°C	-7°C	+95°C	+65°C	10 bar	6 bar	0.5 lt/min
 radiatori radiators	-20°C	-7°C	+95°C	+65°C	10 bar	6 bar	0.5 lt/min
 raffreddamento cooling	-20°C	-7°C	+95°C	+65°C	10 bar	6 bar	0.5 lt/min
 -20°C: solo con liquido antigelo, glicole, in % max del 30% -20°C: only with antifreeze liquid (glycol) in % max of 30%							

COMPONENTI E MATERIALI 6A00.71 COMPONENTS AND MATERIALS 6A00.71

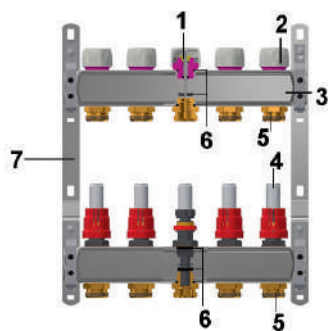

LEGENDA LEGEND	COMPONENTI COMPONENTS	MATERIALI MATERIALS
1	Vitone Mechanical balancing screw	CW617N - UNI EN 12164 Brass CW617N - UNI EN 12164
2	Manopola Knob	ABS
3	Collettore Manifold	AISI 304 - EN 1.4301
4	Flussimetri Flow meter	PLASTICA PLASTIC
5	Nippli Connecting Nipples	CW617N - UNI EN 12165 Brass CW617N - UNI EN 12165
6	O-Ring/Guarnizioni O-Ring (tighting)	Elastomero Elastomer
7	Staffe Brackets	FE ZNB

COMPONENTI E MATERIALI 6A00.93 COMPONENTS AND MATERIALS 6A00.93

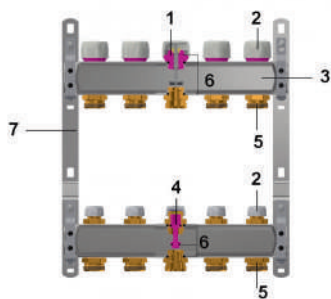

LEGENDA LEGEND	COMPONENTI COMPONENTS	MATERIALI MATERIALS
1	Vitone Headwork	6W617N-UNI EN 12164
2	Manopola Knob	ABS
3	Collettore Manifold	AISI 304 - EN 1430
4	Detentore Lockshield	CW617N - UNI EN 12164 Brass CW617N - UNI EN 12164
5	Nippli Connecting Nipples	6W617N-UNI EN 12165
6	O-Ring	Elastomero Elastomer
7	Staffe Brackets	FE ZNB

CERTIFICAZIONI CERTIFICATIONS

STATO COUNTRY	CERTIFICAZIONE CERTIFICATION	STATO COUNTRY	CERTIFICAZIONE CERTIFICATION	STATO COUNTRY	CERTIFICAZIONE CERTIFICATION

NORMATIVE

- UNI EN ISO 228-1
Filettatura di tubazioni per accoppiamento non a tenuta sul filetto

REGULATIONS

- UNI EN ISO 228-1:2003
Threads complies with UNI EN ISO 228-1:2003 law: "Piping thread for coupling not with tightness on the thread"

FLUSSIMETRI

Funzione "memory-stop" flussimetro.
Sistema di bloccaggio del grado di apertura del flussimetro che consente, alla riapertura del circuito, l'arresto della corsa nella impostazione iniziale (valore di progetto).

FLOWMETER "MEMORY - STOP" FUNCTION

*Memory stop function.
Blocking system of the opening grade of the flowmeter which allows, once the system is reopened, the stopping of the run at its initial setting (project value).*

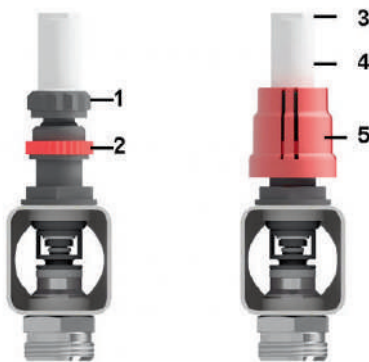

LEGENDA LEGEND	COMPONENTI COMPONENTS
1	Ghiera regolazione Regulation ring
2	Ghiera memory stop Memory stop ring
3	Esagono bicchiere Glass hexagon part
4	Bicchiere Glass
5	Volantino Control

1) Impostare la regolazione del flussimetro a valore di progetto. Il volantino, durante questa operazione, deve essere tolto;

2) Avvitare la ghiera di "Memory-Stop" in senso antiorario (filettatura sinistra) fino ad arrivare a fine corsa;

3) Riposizionare il volantino. Agendo sul volantino (ruotando in senso orario) è possibile chiudere il singolo circuito. Ruotando in senso contrario fino al suo bloccaggio, è possibile riaprire il circuito, fino a valore di progetto impostato.

Tramite le due asole presenti sul volantino è possibile piombare il Flussimetro, onde evitarne la manomissione della regolazione impostata.

Attenzione: NON utilizzare attrezzi per la manovra/regolazione del flussimetro, onde pregiudicarne il corretto funzionamento del flussimetro stesso.

1) Set the Flowmeter control to the design value. The control wheel must be removed during this operation.

2) Turn the "Memory stop" ferrule anticlockwise (left-hand thread) to the end of its travel.

3) Put the control wheel back on. The individual circuit can be closed by turning the wheel clockwise. By turning it the other way up to the stop it is possible to reopen the circuit to the set design value.

Using the two holes in the control wheel it is possible to seal the Flowmeter so as to prevent tampering with the setting.

Warning: do NOT use any tools to turn/manipulate the Flowmeter, as to do so could stop it working properly.

FLUSSIMETRO 0.5 L FLOWMETER 0.5 L		
DP Pa	DP kpa	Q l/h
10	0.01	8
100	0.1	25
500	0.5	60
1000	1	82
5000	5	185
10000	10	260
20000	20	365
30000	30	450
40000	40	520
50000	50	585
60000	60	640
70000	70	690
80000	80	740
90000	90	785
100000	100	825

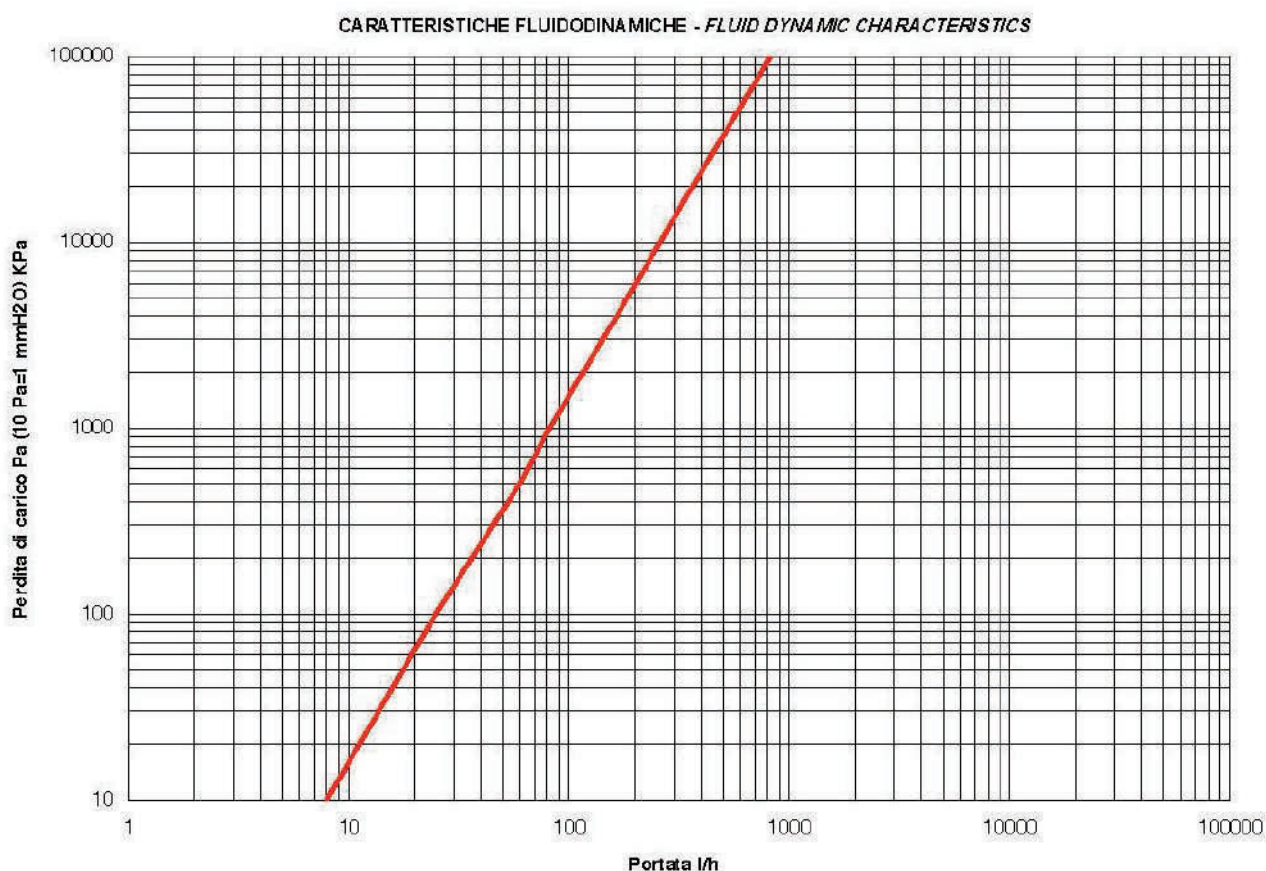

ISTRUZIONI DI MANUTENZIONE

Il bicchiere può essere smontato ed ispezionato per una eventuale pulizia anche con impianto funzionante.

- 1) Chiudere il flussimetro ruotando l'anello, non prima di aver registrato il bilanciamento (l/min) dell'impianto
- 2) Con l'ausilio di una chiave esagonale svitare il bicchiere agendo sulla struttura esagonale dello stesso
- 3) Procedere alla pulizia del bicchiere
- 4) Riavvitare il bicchiere nella posizione originale, bilanciando nuovamente l'impianto.

MAINTENANCE INSTRUCTIONS

The glass can be disassembled in order to check its cleanliness, even when the installation is working.

- 1) Close the flow meter turning the ring, but not before than having recorded the installation balancing (l/min)
- 2) With the help of a hexagonal wrench, unscrew the glass by acting on the hexagonal structure of the glass
- 3) Clean the glass
- 4) Re-insert the glass in its original position, balancing again the installation

BILANCIAMENTO MECCANICO DELL'IMPIANTO

I misuratori di portata (o flussimetri) e i detentori a memoria meccanica (detentori) sono situati sulla mandata del circuito, in questo modo è possibile stabilire il valore della portata teorica dell'impianto idraulico, tramite la regolazione dei misuratori/regolatori, che sarà

MECHANICAL BALANCING OF THE INSTALLATION

Flow measuring devices (flow meters) are located on the delivery circuit, making it possible to establish the theoretical flow value of the hydraulic system through the adjustment of the meters/regulators, which will be carried out by the installation technician.

effettuata del tecnico installatore.
Tale regolazione si deve compiere con la valvola in posizione di ritorno totalmente aperta.
Accertato che le portate di ogni circuito idraulico determinano una perdita di carico dell'impianto, è fondamentale che le regolazioni siano eseguite manualmente per tutti gli anelli dei misuratori, fino a raggiungere i valori di portata in l/ min determinati dal progetto.

*You have to adjust it when the valve is in the back-draft position and completely open.
Given that the flow of each plumbing circuit causes a loose in installation capacity, for each ring of the flow meter is basic that the adjustment are made by hand until you reach flow value in litre/minutes decided by the plan.*

DETENTORI (vitoni a memoria meccanica)

Istruzioni di regolazione dei collettori con detentori:

- Svitare il tappo
- Con la chiave a brugola avvitare l'otturatore fino a raggiungere la posizione di chiusura
- Il detentore è pronto per essere regolato come da tabella sottostante
- Utilizzare la ghiera per creare un fine corsa meccanico, avvitandola a battuta sull'otturatore una volta impostata la portata desiderata. In questo modo è possibile aprire e chiudere l'otturatore senza perdere la regolazione impostata.

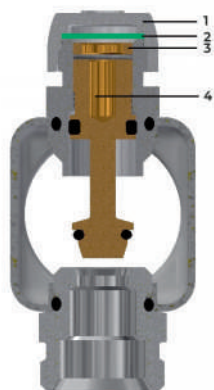

LOCKSHIELDS (mechanical memory stem)

Calibration instructions for manifolds with lockshields:

- *Unscrew the cap*
- *Using a hex key, tighten the cut-off valve until it's completely closed*
- *The lockshield is ready to be adjusted as per the chart below*
- *Use the closing ring to create a mechanical stop, tightening it down to the cut-off valve once the desired flow has been set. By so doing, the cut-off valve can be opened and closed without altering the set calibration.*

LEGENDA LEGEND	COMPONENTI COMPONENTS
1	Tappo Cap
2	Guarnizione Gasket
3	Ghiera Closing ring
4	Otturatore Cut off valve

Posizione /Position	N° giri /turns	Kvs (m3/h)
1	1/2	0.09
2	1	0.27
3	1+1/2	0.73
4	2	0.91
5	2+1/2	1.08
6	3	1.26
7	3+1/2	1.41
8	4	1.53
9	4+1/2	1.65
10	5	1.76
11	5+1/2	1.85
12	tutto aperto completely open	1.92

PROTEZIONE DEL BILANCIAMENTO IDRAULICO CONTRO MANOMISSIONI

La regolazione dei regolatori e dei misuratori di portata può essere bloccata con un coperchio di arresto, eventualmente piombato.

PROTECTING HYDRAULIC BALANCING FROM TAMPERING

Adjustment of the flow regulators and meters can be blocked by a protective cover, sealed if necessary.

Valvole di intercettazione predisposte per comando elettrotermico Pre-set shut-off valves for electrothermal command

1. Svitare la manopola di protezione
2. Posizionare la testa termoelettrica sulla valvola
3. Avvitare a mano la ghiera metallica (filettatura M30x1.5)
4. Eseguire i collegamenti elettrici

1. *Unscrew the protection handle*
2. *Place the electrothermal head on the valve*
3. *Tighten the metal closing ring by hand (threading: M30x1.5)*
4. *Complete the electrical connections*

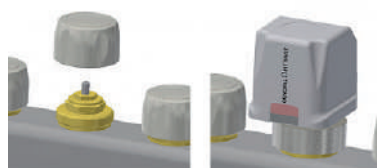

COMPONENTI: 6A00.55 COMPONENTS: 6A00.55

Collettore di distribuzione composto da:

- Collettore di mandata completo di flussimetri e nipli con derivazione 3/4" Eurocono
- Collettore di ritorno completo di valvole di intercettazione predisposte per il comando elettrotermico e nipli con derivazione 3/4" eurocono
- Staffe di fissaggio
- Valvola di sfiato manuale, rubinetto di carico/scarico e tappo

Manifold composed of:

- *Delivery manifold complete with flow meters and nipples with 3/4" Eurocone connectors*
- *Return manifold complete with shut-off valves arranged for electrothermal control and 3/4" eurocone nipples*
- *Brackets*
- *Manual vent valve, fill/drain tap and cap*

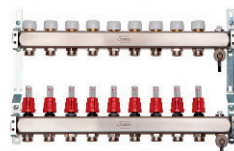

CONNESSIONI 6A00.55 CONNECTIONS 6A00.55

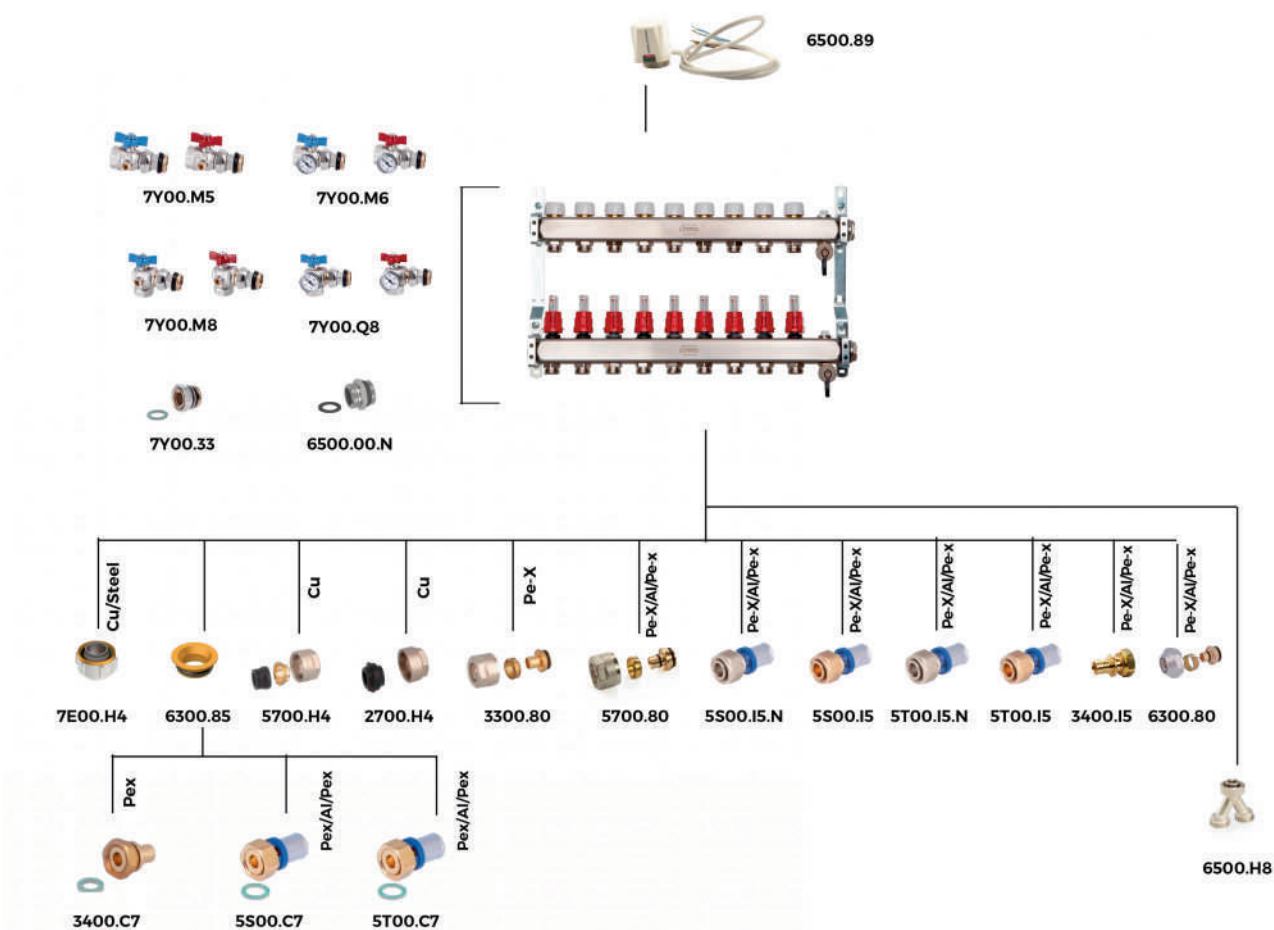

INSERTI E RACCORDI INSERTS AND FITTINGS

CODICE CODE	DESCRIZIONE DESCRIPTION	TUBO PIPE
7Y00.M5	Valvola a sfera compatta bocchettone con farfalla senza termometro Compact ball valve coupling with butterfly, without thermometer	
7Y00.M6	Valvola a sfera compatta bocchettone con farfalla con termometro Compact 90-degree ball valve coupling with butterfly and thermometer	
7Y00.M8	Valvola a sfera compatta a squadra bocchettone con farfalla senza termometro Compact 90-degree ball valve coupling with butterfly, no thermometer	
7Y00.Q8	Valvola a sfera compatta a squadra bocchettone con farfalla con termometro Compact 90-degree ball valve coupling with butterfly, no thermometer	
7Y00.33	Raccordo collettore nichelato Nickel-plated manifold fitting	
6300.85	Adattatore sede piana eurocono Eurocone flat seal adapter	
7E00.H4	Adattatore Adapter	Tubo rame/acciaio Copper/Steel pipe
6300.80	Dado nichelato, ogiva e inserto eurocono Nickel plated nut, olive and insert eurocone	Tubo multistrato Multilayer pipe

INSERTI E RACCORDI INSERTS AND FITTINGS		
3400.C7	Raccordo diritto sede piana con girello Straight fitting with loose nut and flat washer	Tubo Pe-X Pe-X pipe
5500.C7	Raccordo diritto sede piana con girello Straight fitting with loose nut and flat washer	Tubo multistrato Multilayer pipe
5T00.C7	Raccordo diritto sede piana con girello Straight fitting with loose nut and flat washer	Tubo multistrato Multilayer pipe
5700.H4	Dado nichelato con ogiva e guarnizione inclusa Nickel plated nut with assembled ring and gasket	Tubo rame Copper pipe
2700.H4	Dado nichelato con ogiva e guarnizione inclusa Nickel plated nut with assembled ring and gasket	Tubo rame Copper pipe
3300.80	Dado nichelato, ogiva e inserto eurocono Nickel plated nut, olive and insert eurocone	Tubo Pe-X Pe-X pipe
5700.80	Dado nichelato, ogiva e inserto eurocono Nickel plated nut, olive and insert eurocone	Tubo multistrato Multilayer pipe
5500.I5	Raccordo dritto sede conica O-Ring con girello- Straight fitting with loose nut and conical connection	Tubo multistrato Multilayer pipe
5500.I5.N	Raccordo dritto nichelato sede conica O-Ring con girello- Nickel-plated straight fitting with loose nut and conical connection	Tubo multistrato Multilayer pipe
5T00.I5	Raccordo dritto sede conica O-Ring con girello- Straight fitting with loose nut and conical connection	Tubo multistrato Multilayer pipe
5T00.I5.N	Raccordo dritto nichelato sede conica O-Ring con girello- Nickel-plated straight fitting with loose nut and conical connection	Tubo multistrato Multilayer pipe
3400.I5	Raccordo dritto sede conica O-Ring con girello- Straight fitting with loose nut and conical connection	tubo Pe-X Pe-X pipe
6500.H8	Raccordo sdoppiatore nichelato Eurocone nickel plated splitter	
6500.00.N	Raccordo m/m con o-ring e guarnizione piatta Male fitting with o-ring and flat gasket	

DIMENSIONI 6A00.55
DIMENSIONS 6A00.55

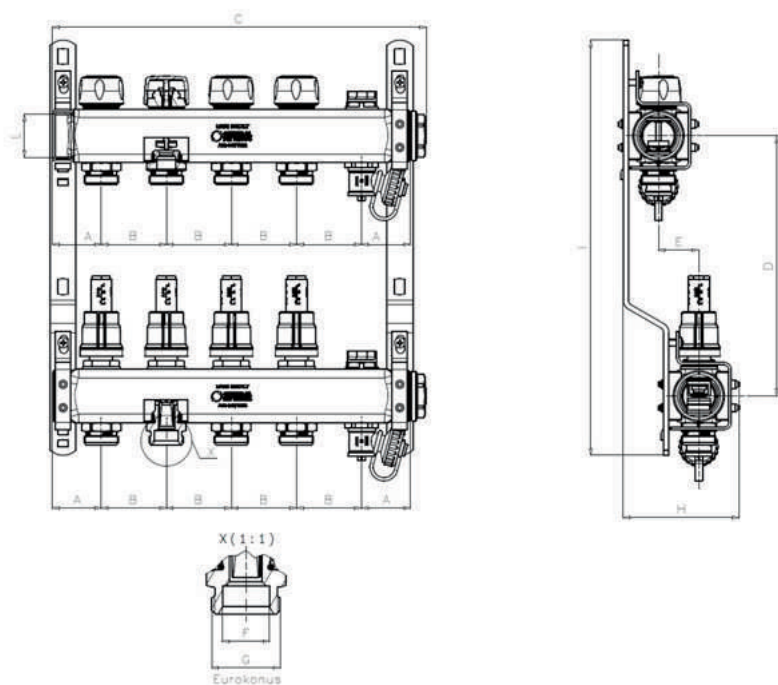

CODICE CODE	A	B	C	D	E***	F	G	H*	H**	I	VIE	TUBO Ø
6A00551100502A	37.5	50	137	200	31/18	18.1	3/4"	89	76	319	2	1"-3/4" Ek.
6A00551100503A	37.5	50	187	200	31/18	18.1	3/4"	89	76	319	3	1"-3/4" Ek.
6A00551100504A	37.5	50	237	200	31/18	18.1	3/4"	89	76	319	4	1"-3/4" Ek.
6A00551100505A	37.5	50	287	200	31/18	18.1	3/4"	89	76	319	5	1"-3/4" Ek.
6A00551100506A	37.5	50	337	200	31/18	18.1	3/4"	89	76	319	6	1"-3/4" Ek.
6A00551100507A	37.5	50	387	200	31/18	18.1	3/4"	89	76	319	7	1"-3/4" Ek.
6A00551100508A	37.5	50	437	200	31/18	18.1	3/4"	89	76	319	8	1"-3/4" Ek.
6A00551100509A	37.5	50	487	200	31/18	18.1	3/4"	89	76	319	9	1"-3/4" Ek.
6A00551100510A	37.5	50	537	200	31/18	18.1	3/4"	89	76	319	10	1"-3/4" Ek.
6A00551100511A	37.5	50	587	200	31/18	18.1	3/4"	89	76	319	11	1"-3/4" Ek.
6A00551100512A	37.5	50	637	200	31/18	18.1	3/4"	89	76	319	12	1"-3/4" Ek.

* staffa standard già montata (H89) per utilizzo su cassetta di profondità 110 (AC0080I500000A / AC0080I700000A / AC0080I100000A)

** staffa opzionale, non presente nella confezione (H76), per utilizzo su cassetta di profondità 90 (AC0080I550090A / AC0080I700090A / AC0080I850090A / AC0080I100090A) e su cassetta di profondità 110 (AC0080I500000A / AC0080I700000A / AC0080I100000A)

***staffa standard/staffa opzionale

* standard bracket already assembled (H89) for use with 110 depth case (AC0080I500000A / AC0080I700000A / AC0080I100000A)

**Optional bracket, not present in the package (H76), for use with 90 depth case (AC0080I550090A / AC0080I700090A / AC0080I850090A / AC0080I100090A) and 110 depth case (AC0080I500000A / AC0080I700000A / AC0080I100000A)

***standard/optional bracket

COMPONENTI: 6A00.71
COMPONENTS: 6A00.71

Collettore di distribuzione composto da:

- Collettore di mandata completo di flussimetri e nipples con derivazione 3/4" Eurocono
- Collettore di ritorno completo di valvole di intercettazione predisposte per il comando elettrotermico e nipples con derivazione 3/4" eurocono
- Staffe di fissaggio

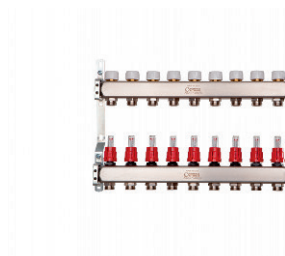

Manifold composed of:

- *Delivery manifold complete with flow meters and nipples with 3/4" Eurocone connectors*
- *Return manifold complete with shut-off valves arranged for electrothermal control and 3/4" eurocone nipples*
- *Brackets*

CONNESSIONI 6A00.71 CONNECTIONS 6A00.71

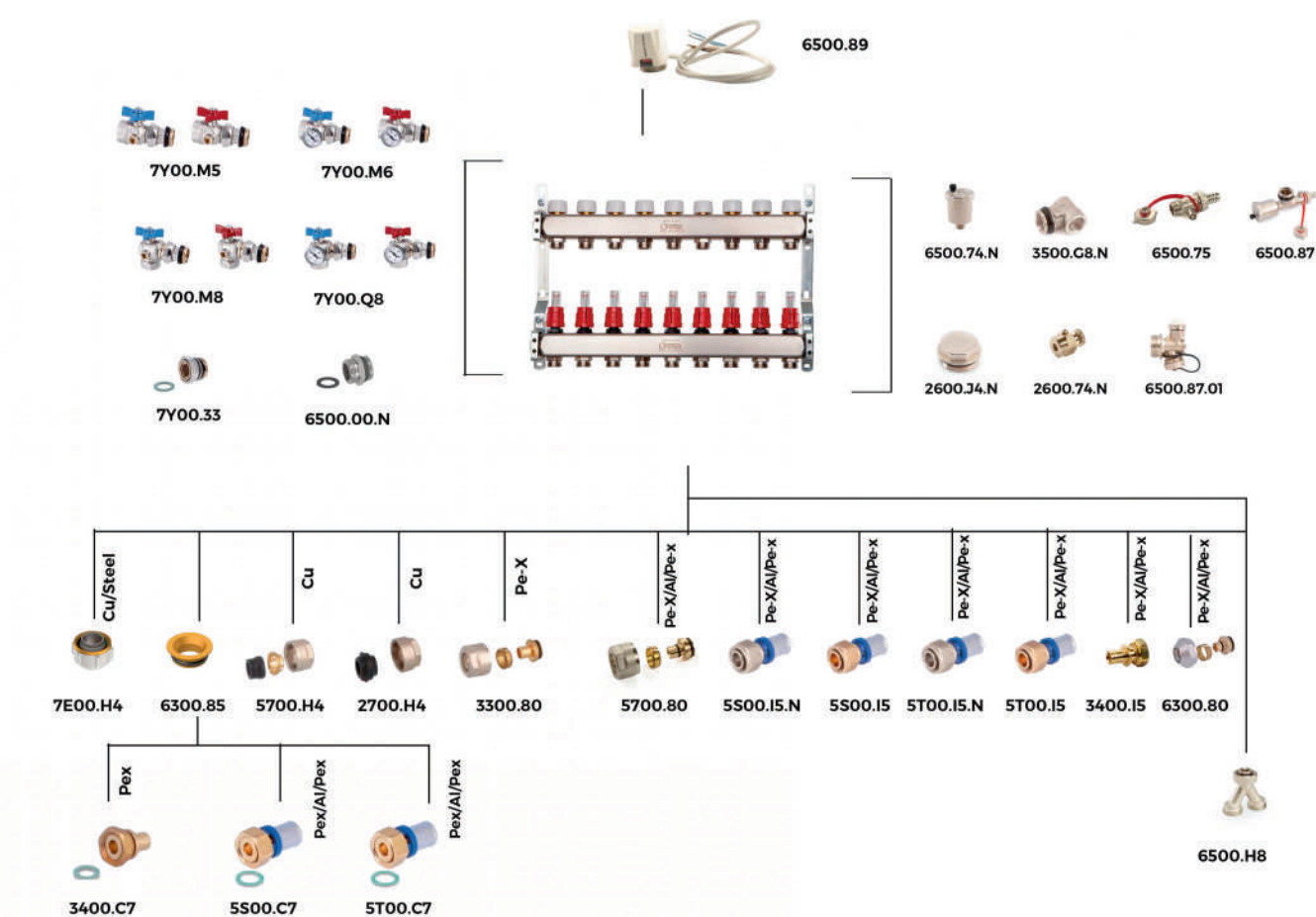

INSERTI E RACCORDI INSERTS AND FITTINGS

CODICE CODE	DESCRIZIONE DESCRIPTION	TUBO PIPE
7Y00.M5	Valvola a sfera compatta bocchettone con farfalla senza termometro Compact ball valve coupling with butterfly, without thermometer	
7Y00.M6	Valvola a sfera compatta bocchettone con farfalla con termometro Compact 90-degree ball valve coupling with butterfly and thermometer	
7Y00.M8	Valvola a sfera compatta a squadra bocchettone con farfalla senza termometro Compact 90-degree ball valve coupling with butterfly, no thermometer	
7Y00.Q8	Valvola a sfera compatta a squadra bocchettone con farfalla con termometro Compact 90-degree ball valve coupling with butterfly, no thermometer	
7Y00.33	Raccordo collettore nichelato Nickel-plated manifold fitting	
6500.74.N	Valvola di sfianto automatica nichelata Nickel plated automatic air vent valve	
3500.G8.N	Finale per collettore nichelato Nickel plated end piece for manifold	
2600.74.N	Rubinetto sfianto calorifero tenuta O-Ring nichelato Nickel plated air outlet valve with O-Ring	

INSERTI E RACCORDI INSERTS AND FITTINGS		
6500.75	Rubinetto carico/scarico Charge/Discharge valve	
6500.87	Kit terminale per collettore nichelato automatico Automatic manifold terminal kit	
6500.87.01	Kit terminale per collettore nichelato manuale Manual manifold terminal kit	
2600.J4	Tappo maschio nichelato con O-Ring Male cup with O-Ring	
6300.85	Adattatore sede piana eurocono Eurocone flat seal adapter	
7E00.H4	Adattatore Adapter	Tubo rame/acciaio Copper/Steel pipe
6300.80	Dado nichelato, ogiva e inserto eurocono Nickel plated nut, olive and insert eurocone	Tubo multistrato Multilayer pipe
3400.C7	Raccordo dritto sede piana con girello Straight fitting with loose nut and flat washer	Tubo Pe-X Pe-X pipe
5500.C7	Raccordo dritto sede piana con girello Straight fitting with loose nut and flat washer	Tubo multistrato Multilayer pipe
5T00.C7	Raccordo dritto sede piana con girello Straight fitting with loose nut and flat washer	Tubo multistrato Multilayer pipe
5700.H4	Dado nichelato con ogiva e guarnizione inclusa Nickel plated nut with assembled ring and gasket	Tubo rame Copper pipe
2700.H4	Dado nichelato con ogiva e guarnizione inclusa Nickel plated nut with assembled ring and gasket	Tubo rame Copper pipe
3300.80	Dado nichelato, ogiva e inserto eurocono Nickel plated nut, olive and insert eurocone	Tubo Pe-X Pe-X pipe
5700.80	Dado nichelato, ogiva e inserto eurocono Nickel plated nut, olive and insert eurocone	Tubo multistrato Multilayer pipe
5500.I5	Raccordo dritto sede conica O-Ring con girello- Straight fitting with loose nut and conical connection	Tubo multistrato Multilayer pipe
5500.I5.N	Raccordo dritto nichelato sede conica O-Ring con girello- Nickel-plated straight fitting with loose nut and conical connection	Tubo multistrato Multilayer pipe
5T00.I5	Raccordo dritto sede conica O-Ring con girello- Straight fitting with loose nut and conical connection	Tubo multistrato Multilayer pipe
5T00.I5.N	Raccordo dritto nichelato sede conica O-Ring con girello- Nickel-plated straight fitting with loose nut and conical connection	Tubo multistrato Multilayer pipe
3400.I5	Raccordo dritto sede conica O-Ring con girello- Straight fitting with loose nut and conical connection	tubo Pe-X Pe-X pipe
6500.H8	Raccordo sdoppiatore nichelato Eurocone nickel plated splitter	

DIMENSIONI 6A00.71
DIMENSIONS 6A00.71

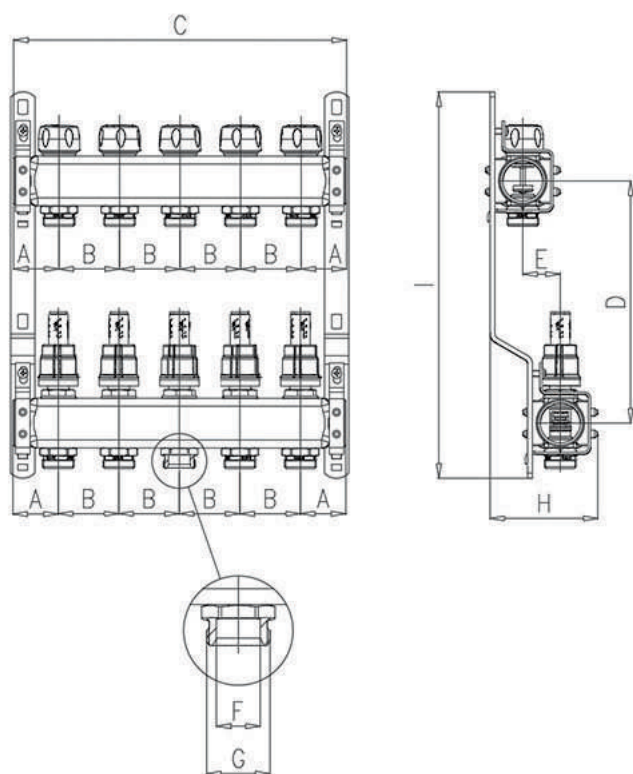

CODICE CODE	A	B	C	D	E***	F	G	H*	H**	I	VIE	TUBO Ø
6A00711100502A	37.5	50	125	200	31/18	Ø18,1	3/4"	89	76	319	2	1"-3/4"Ek.
6A00711100503A	37.5	50	175	200	31/18	Ø18,1	3/4"	89	76	319	3	1"-3/4"Ek.
6A00711100504A	37.5	50	225	200	31/18	Ø18,1	3/4"	89	76	319	4	1"-3/4"Ek.
6A00711100505A	37.5	50	275	200	31/18	Ø18,1	3/4"	89	76	319	5	1"-3/4"Ek.
6A00711100506A	37.5	50	325	200	31/18	Ø18,1	3/4"	89	76	319	6	1"-3/4"Ek.
6A00711100507A	37.5	50	375	200	31/18	Ø18,1	3/4"	89	76	319	7	1"-3/4"Ek.
6A00711100508A	37.5	50	425	200	31/18	Ø18,1	3/4"	89	76	319	8	1"-3/4"Ek.
6A00711100509A	37.5	50	475	200	31/18	Ø18,1	3/4"	89	76	319	9	1"-3/4"Ek.
6A00711100510A	37.5	50	525	200	31/18	Ø18,1	3/4"	89	76	319	10	1"-3/4"Ek.
6A00711100511A	37.5	50	575	200	31/18	Ø18,1	3/4"	89	76	319	11	1"-3/4"Ek.
6A00711100512A	37.5	50	625	200	31/18	Ø18,1	3/4"	89	76	319	12	1"-3/4"Ek.
6A00711100513A	37.5	50	675	200	31/18	Ø18,1	3/4"	89	76	319	13	1"-3/4"Ek.

* staffa standard già montata (H89) per utilizzo su cassetta di profondità 110 (AC00801500000A / AC00801700000A / AC00801100000A)

** staffa opzionale, non presente nella confezione (H76), per utilizzo su cassetta di profondità 90 (AC00801550090A / AC00801700090A / AC00801850090A / AC00801100090A) e su cassetta di profondità 110 (AC00801500000A / AC00801700000A / AC00801100000A)

***staffa standard/staffa opzionale

* standard bracket already assembled (H89) for use with 110 depth case (AC00801500000A / AC00801700000A / AC00801100000A)

**Optional bracket, not present in the package (H76), for use with 90 depth case (AC00801550090A / AC00801700090A / AC00801850090A / AC00801100090A) and 110 depth case (AC00801500000A / AC00801700000A / AC00801100000A)

***standard/optional bracket

COMPONENTI: 6A00.72
COMPONENTS: 6A00.72

Collettore di distribuzione composto da:

- Collettore di mandata completo di flussimetri e nipli con derivazione 3/4" Eurocono
- Collettore di ritorno completo di valvole di intercettazione predisposte per comando elettrotermico
- Derivazioni 3/4" Eurocono
- Staffe di fissaggio
- Kit terminale per collettore nichelato
- Valvola a sfera compatta bocchettone con farfalla con termometro

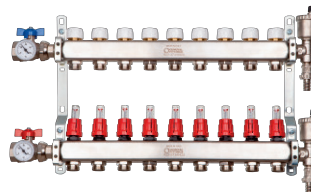

Manifold composed of:

- Delivery manifold complete with flow meters and nipples with 3/4" Eurocone connectors*
- Return manifold complete with pre-arranged shut-off valves for electrothermal command*
- 3/4" Eurocone adapters*
- Brackets*
- Manifold termination kit*
- Compact 90-degree ball valve coupling with butterfly and thermometer*

CONNESSIONI 6A00.72 CONNECTIONS 6A00.72

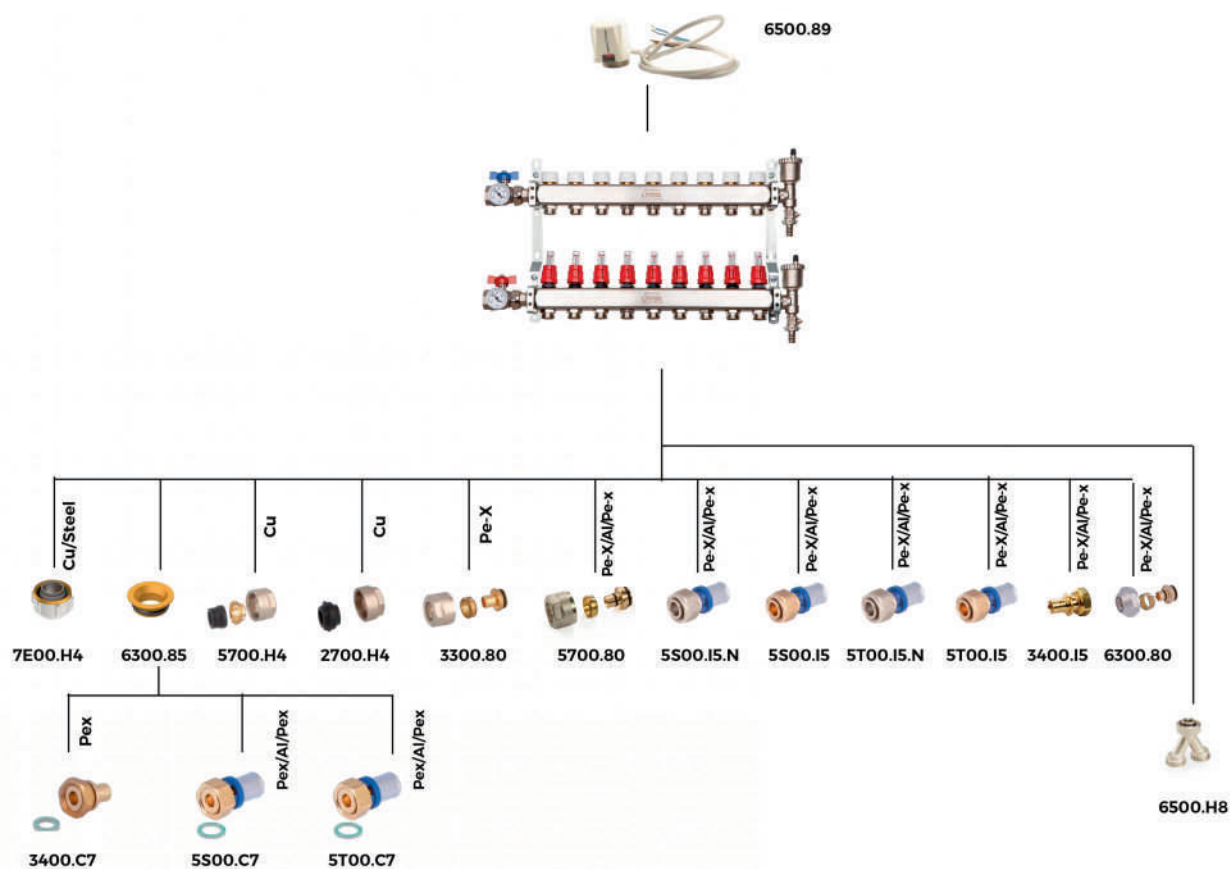

INSERTI E RACCORDI INSERTS AND FITTINGS

CODICE CODE	DESCRIZIONE DESCRIPTION	TUBO PIPE
6300.85	Adattatore sede piana eurocono Eurocone flat seal adapter	
7E00.H4	Adattatore Adapter	Tubo rame/acciaio Copper/Steel pipe
6300.80	Dado nichelato, ogiva e inserto eurocono Nickel plated nut, olive and insert eurocone	Tubo multistrato Multilayer pipe
3400.C7	Raccordo diritto sede piana con girello Straight fitting with loose nut and flat washer	Tubo Pe-X Pe-X pipe
5500.C7	Raccordo diritto sede piana con girello Straight fitting with loose nut and flat washer	Tubo multistrato Multilayer pipe
5T00.C7	Raccordo diritto sede piana con girello Straight fitting with loose nut and flat washer	Tubo multistrato Multilayer pipe
5700.H4	Dado nichelato con ogiva e guarnizione inclusa Nickel plated nut with assembled ring and gasket	Tubo rame Copper pipe
2700.H4	Dado nichelato con ogiva e guarnizione inclusa Nickel plated nut with assembled ring and gasket	Tubo rame Copper pipe
3300.80	Dado nichelato, ogiva e inserto eurocono Nickel plated nut, olive and insert eurocone	Tubo Pe-X Pe-X pipe
5700.80	Dado nichelato, ogiva e inserto eurocono Nickel plated nut, olive and insert eurocone	Tubo multistrato Multilayer pipe

INSERTI E RACCORDI INSERTS AND FITTINGS		
5500.I5	Raccordo dritto sede conica O-Ring con girello- Straight fitting with loose nut and conical connection	Tubo multistrato Multilayer pipe
5500.I5.N	Raccordo dritto nichelato sede conica O-Ring con girello- Nickel-plated straight fitting with loose nut and conical connection	Tubo multistrato Multilayer pipe
5T00.I5	Raccordo dritto sede conica O-Ring con girello- Straight fitting with loose nut and conical connection	Tubo multistrato Multilayer pipe
5T00.I5.N	Raccordo dritto nichelato sede conica O-Ring con girello- Nickel-plated straight fitting with loose nut and conical connection	Tubo multistrato Multilayer pipe
3400.I5	Raccordo dritto sede conica O-Ring con girello- Straight fitting with loose nut and conical connection	tubo Pe-X Pe-X pipe
6500.H8	Raccordo sdoppiatore nichelato Eurocone nickel plated splitter	

DIMENSIONI 6A00.72
DIMENSIONS 6A00.72

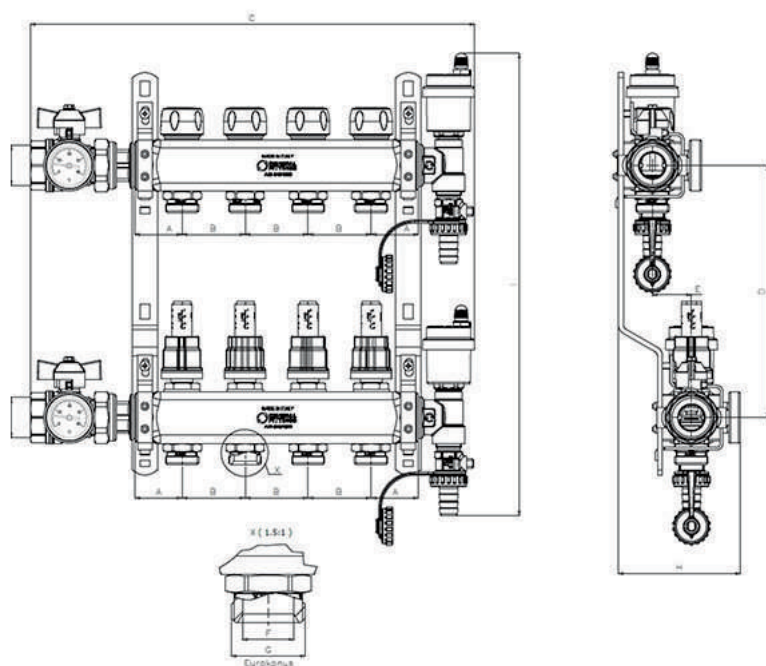

CODICE CODE	A	B	C	D	E***	F	G	H*	H**	I	VIE	TUBO Ø
6A00721100502A	37.5	50	252	200	3/18	18.1	3/4"	97	84	367	2	1"-3/4" Ek.
6A00721100503A	37.5	50	302	200	3/18	18.1	3/4"	97	84	367	3	1"-3/4" Ek.
6A00721100504A	37.5	50	352	200	3/18	18.1	3/4"	97	84	367	4	1"-3/4" Ek.
6A00721100505A	37.5	50	402	200	3/18	18.1	3/4"	97	84	367	5	1"-3/4" Ek.
6A00721100506A	37.5	50	452	200	3/18	18.1	3/4"	97	84	367	6	1"-3/4" Ek.
6A00721100507A	37.5	50	502	200	3/18	18.1	3/4"	97	84	367	7	1"-3/4" Ek.
6A00721100508A	37.5	50	552	200	3/18	18.1	3/4"	97	84	367	8	1"-3/4" Ek.
6A00721100509A	37.5	50	602	200	3/18	18.1	3/4"	97	84	367	9	1"-3/4" Ek.
6A00721100510A	37.5	50	652	200	3/18	18.1	3/4"	97	84	367	10	1"-3/4" Ek.
6A00721100511A	37.5	50	702	200	3/18	18.1	3/4"	97	84	367	11	1"-3/4" Ek.
6A00721100512A	37.5	50	752	200	3/18	18.1	3/4"	97	84	367	12	1"-3/4" Ek.
6A00721100513A	37.5	50	802	200	3/18	18.1	3/4"	97	84	367	13	1"-3/4" Ek.

* staffa standard già montata (H89) per utilizzo su cassetta di profondità 110 (AC00801500000A / AC00801700000A / AC00801100000A)

** staffa opzionale, non presente nella confezione (H76), per utilizzo su cassetta di profondità 90 (AC00801550090A / AC00801700090A / AC00801850090A / AC00801100090A) e su cassetta di profondità 110 (AC00801500000A / AC00801700000A / AC00801100000A)

***staffa standard/staffa opzionale

* standard bracket already assembled (H89) for use with 110 depth case (AC00801500000A / AC00801700000A / AC00801100000A)

**Optional bracket, not present in the package (H76), for use with 90 depth case (AC00801550090A / AC00801700090A / AC00801850090A / AC00801100090A) and 110 depth case (AC00801500000A / AC00801700000A / AC00801100000A)

***standard/optional bracket

COMPONENTI 6A00.93 COMPONENTS 6A00.93

Collettore di distribuzione composto da:

- Collettore di mandata completo di vitoni a memoria meccanica
- Collettore di ritorno completo di valvole di intercettazione predisposte per comando elettrotermico
- Derivazioni 3/4" Eurocono
- Staffe di fissaggio



Manifold composed of:

- *Delivery manifold complete with mechanical memory stems*
- *Return manifold complete with pre-arranged shut-off valves for electrothermal command*
- *3/4" Eurocone adapters*
- *Brackets*

CONNESSIONI 6A00.93 CONNECTIONS 6A00.93

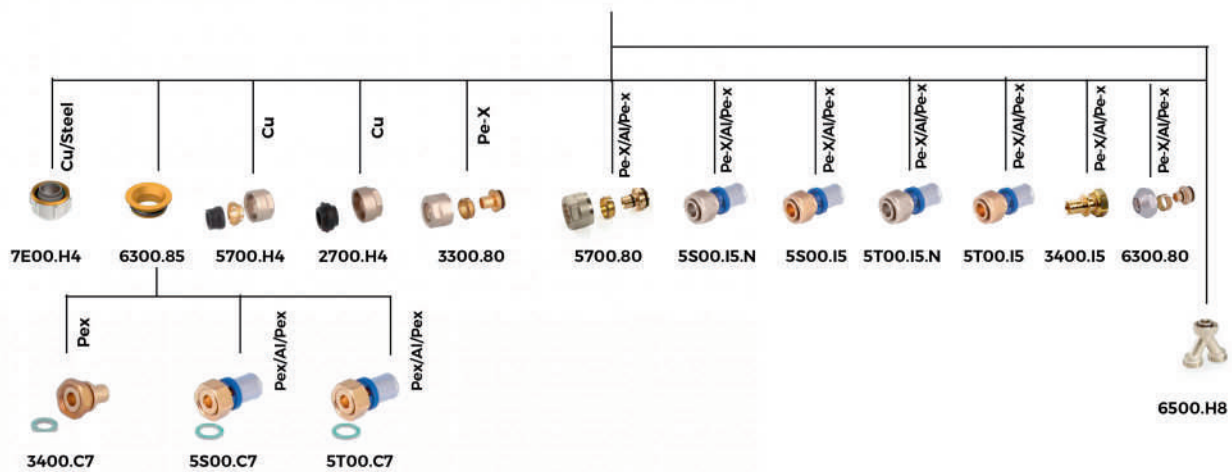
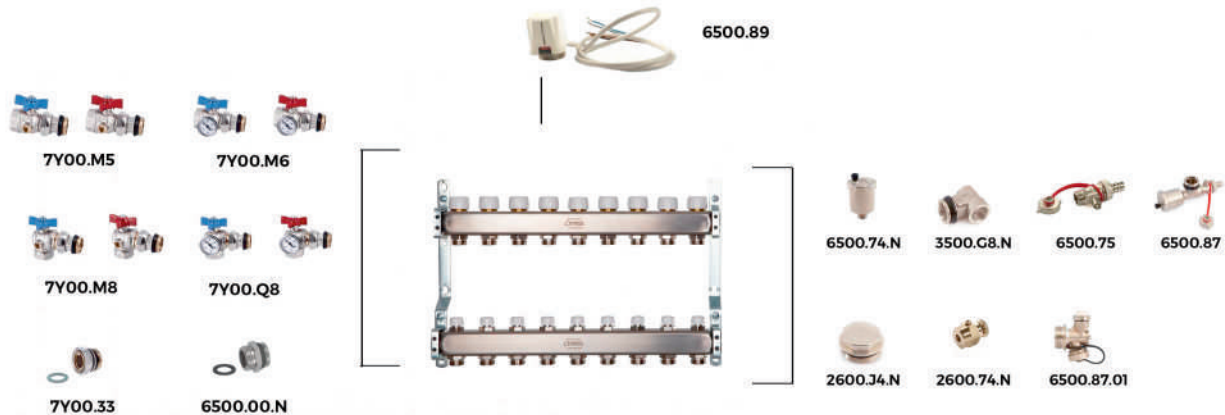

INSERTI E RACCORDI INSERTS AND FITTINGS

CODICE CODE	DESCRIZIONE DESCRIPTION	TUBO PIPE
7Y00.M5	Valvola a sfera compatta bocchettone con farfalla senza termometro Compact ball valve coupling with butterfly, without thermometer	
7Y00.M6	Valvola a sfera compatta bocchettone con farfalla con termometro Compact 90-degree ball valve coupling with butterfly and thermometer	
7Y00.M8	Valvola a sfera compatta a squadra bocchettone con farfalla senza termometro Compact 90-degree ball valve coupling with butterfly, no thermometer	
7Y00.Q8	Valvola a sfera compatta a squadra bocchettone con farfalla con termometro Compact 90-degree ball valve coupling with butterfly, no thermometer	
7Y00.33	Raccordo collettore nichelato Nickel-plated manifold fitting	
6500.74.N	Valvola di sfianto automatica nichelata Nickel plated automatic air vent valve	
3500.G8.N	Finale per collettore nichelato Nickel plated end piece for manifold	
2600.74.N	Rubinetto sfianto calorifero tenuta O-Ring nichelato Nickel plated air outlet valve with O-Ring	

INSERTI E RACCORDI INSERTS AND FITTINGS		
6500.75	Rubinetto carico/scarico Charge/Discharge valve	
6500.87	Kit terminale per collettore nichelato automatico Automatic manifold terminal kit	
6500.87.01	Kit terminale per collettore nichelato manuale Manual manifold terminal kit	
2600.J4	Tappo maschio nichelato con O-Ring Male cup with O-Ring	
6300.85	Adattatore sede piana eurocono Eurocone flat seal adapter	
7E00.H4	Adattatore Adapter	Tubo rame/acciaio Copper/Steel pipe
6300.80	Dado nichelato, ogiva e inserto eurocono Nickel plated nut, olive and insert eurocone	Tubo multistrato Multilayer pipe
3400.C7	Raccordo dritto sede piana con girello Straight fitting with loose nut and flat washer	Tubo Pe-X Pe-X pipe
5500.C7	Raccordo dritto sede piana con girello Straight fitting with loose nut and flat washer	Tubo multistrato Multilayer pipe
5T00.C7	Raccordo dritto sede piana con girello Straight fitting with loose nut and flat washer	Tubo multistrato Multilayer pipe
5700.H4	Dado nichelato con ogiva e guarnizione inclusa Nickel plated nut with assembled ring and gasket	Tubo rame Copper pipe
2700.H4	Dado nichelato con ogiva e guarnizione inclusa Nickel plated nut with assembled ring and gasket	Tubo rame Copper pipe
3300.80	Dado nichelato, ogiva e inserto eurocono Nickel plated nut, olive and insert eurocone	Tubo Pe-X Pe-X pipe
6500.00.N	Raccordo m/m con o-ring e guarnizione piatta Male fitting with o-ring and flat gasket	
5700.80	Dado nichelato, ogiva e inserto eurocono Nickel plated nut, olive and insert eurocone	Tubo multistrato Multilayer pipe
5500.I5	Raccordo dritto sede conica O-Ring con girello- Straight fitting with loose nut and conical connection	Tubo multistrato Multilayer pipe
5500.I5.N	Raccordo dritto nichelato sede conica O-Ring con girello- Nickel-plated straight fitting with loose nut and conical connection	Tubo multistrato Multilayer pipe
5T00.I5	Raccordo dritto sede conica O-Ring con girello- Straight fitting with loose nut and conical connection	Tubo multistrato Multilayer pipe
5T00.I5.N	Raccordo dritto nichelato sede conica O-Ring con girello- Nickel-plated straight fitting with loose nut and conical connection	Tubo multistrato Multilayer pipe
3400.I5	Raccordo dritto sede conica O-Ring con girello- Straight fitting with loose nut and conical connection	tubo Pe-X Pe-X pipe
6500.H8	Raccordo sdoppiatore nichelato Eurocone nickel plated splitter	

DIMENSIONI 6A00.93
DIMENSIONS 6A00.93

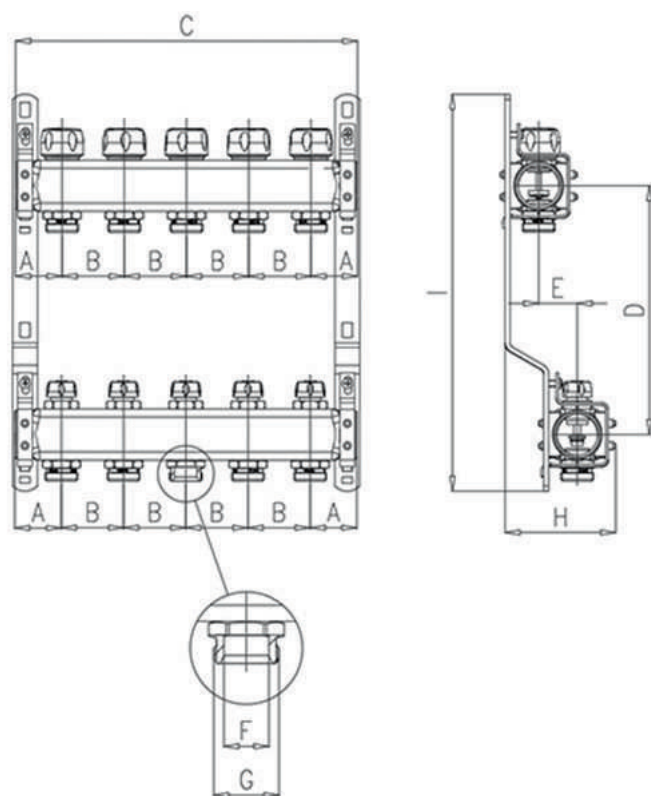

CODICE CODE	A	B	C	D	E***	F	G	H*	H**	I	VIE	TUBO Ø
6A00931100502A	37.5	50	125	200	31/18	Ø18,1	3/4"	89	76	319	2	1"-3/4"Ek.
6A00931100503A	37.5	50	175	200	31/18	Ø18,1	3/4"	89	76	319	3	1"-3/4"Ek.
6A00931100504A	37.5	50	225	200	31/18	Ø18,1	3/4"	89	76	319	4	1"-3/4"Ek.
6A00931100505A	37.5	50	275	200	31/18	Ø18,1	3/4"	89	76	319	5	1"-3/4"Ek.
6A00931100506A	37.5	50	325	200	31/18	Ø18,1	3/4"	89	76	319	6	1"-3/4"Ek.
6A00931100507A	37.5	50	375	200	31/18	Ø18,1	3/4"	89	76	319	7	1"-3/4"Ek.
6A00931100508A	37.5	50	425	200	31/18	Ø18,1	3/4"	89	76	319	8	1"-3/4"Ek.
6A00931100509A	37.5	50	475	200	31/18	Ø18,1	3/4"	89	76	319	9	1"-3/4"Ek.
6A00931100510A	37.5	50	525	200	31/18	Ø18,1	3/4"	89	76	319	10	1"-3/4"Ek.
6A00931100511A	37.5	50	575	200	31/18	Ø18,1	3/4"	89	76	319	11	1"-3/4"Ek.
6A00931100512A	37.5	50	625	200	31/18	Ø18,1	3/4"	89	76	319	12	1"-3/4"Ek.
6A00931100513A	37.5	50	675	200	31/18	Ø18,1	3/4"	89	76	319	13	1"-3/4"Ek.

* staffa standard già montata (H89) per utilizzo su cassetta di profondità 110 (AC00801500000A / AC00801700000A / AC00801100000A)

** staffa opzionale, non presente nella confezione (H76), per utilizzo su cassetta di profondità 90 (AC00801550090A / AC00801700090A / AC00801850090A / AC00801100090A) e su cassetta di profondità 110 (AC00801500000A / AC00801700000A / AC00801100000A)

***staffa standard/staffa opzionale

* standard bracket already assembled (H89) for use with 110 depth case (AC00801500000A / AC00801700000A / AC00801100000A)



**Optional bracket, not present in the package (H76), for use with 90 depth case (AC00801550090A / AC00801700090A / AC00801850090A / AC00801100090A) and 110 depth case (AC00801500000A / AC00801700000A / AC00801100000A)

***standard/optional bracket

6A00.55

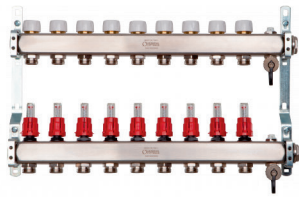
COLLETTORE IN ACCIAIO INOX CON FLUSSIMETRI,
VALVOLE DI SFIATO, DI CARICO/SCARICO E TAPPI.
STAINLESS STEEL MANIFOLD WITH FLOWMETERS,
AIR VENT AND CHARGE/DISCHARGE VALVES, TAPS





CODICE			
6A0055I100502A	2	1"	3/4" EK
6A0055I100503A	3	1"	3/4" EK
6A0055I100504A	4	1"	3/4" EK
6A0055I100505A	5	1"	3/4" EK
6A0055I100506A	6	1"	3/4" EK
6A0055I100507A	7	1"	3/4" EK
6A0055I100508A	8	1"	3/4" EK
6A0055I100509A	9	1"	3/4" EK
6A0055I100510A	10	1"	3/4" EK
6A0055I100511A	11	1"	3/4" EK
6A0055I100512A	12	1"	3/4" EK

6A00.71

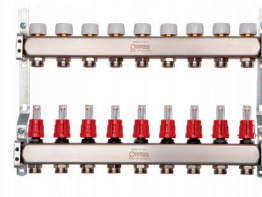
COLLETTORE DI DISTRIBUZIONE IN ACCIAIO INOX
CON FLUSSIMETRI
STAINLESS STEEL MANIFOLD WITH FLOW METERS







CODICE			
6A0071I100502A	2	1"	3/4" EK
6A0071I100503A	3	1"	3/4" EK
6A0071I100504A	4	1"	3/4" EK
6A0071I100505A	5	1"	3/4" EK
6A0071I100506A	6	1"	3/4" EK
6A0071I100507A	7	1"	3/4" EK
6A0071I100508A	8	1"	3/4" EK
6A0071I100509A	9	1"	3/4" EK
6A0071I100510A	10	1"	3/4" EK
6A0071I100511A	11	1"	3/4" EK
6A0071I100512A	12	1"	3/4" EK
6A0071I100513A	13	1"	3/4" EK

6A00.72

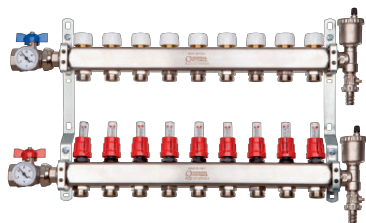
COLLETORE DI DISTRIBUZIONE IN ACCIAIO INOX
CON FLUSSIMETRI, VALVOLE A SFERA, KIT
TERMINALE CON VALVOLE DI SFIATO E DI
CARICO/SCARICO

STAINLESS STEEL MANIFOLD WITH FLOW METERS,
BALL VALVES, TERMINAL KIT WITH AIR VENT AND
CHARGE/DISCHARGE VALVES





CODICE			
6A0072I100502A	2	1"	3/4" EK
6A0072I100503A	3	1"	3/4" EK
6A0072I100504A	4	1"	3/4" EK
6A0072I100505A	5	1"	3/4" EK
6A0072I100506A	6	1"	3/4" EK
6A0072I100507A	7	1"	3/4" EK
6A0072I100508A	8	1"	3/4" EK
6A0072I100509A	9	1"	3/4" EK
6A0072I100510A	10	1"	3/4" EK
6A0072I100511A	11	1"	3/4" EK
6A0072I100512A	12	1"	3/4" EK
6A0072I100513A	13	1"	3/4" EK

6A00.93

COLLETORE DI DISTRIBUZIONE IN ACCIAIO INOX
CON DETENTORI
STAINLESS STEEL MANIFOLD WITH LOCKSHIELDS



CODICE			
6A0093I100502A	2	1"	3/4" EK
6A0093I100503A	3	1"	3/4" EK
6A0093I100504A	4	1"	3/4" EK
6A0093I100505A	5	1"	3/4" EK
6A0093I100506A	6	1"	3/4" EK
6A0093I100507A	7	1"	3/4" EK
6A0093I100508A	8	1"	3/4" EK
6A0093I100509A	9	1"	3/4" EK
6A0093I100510A	10	1"	3/4" EK
6A0093I100511A	11	1"	3/4" EK
6A0093I100512A	12	1"	3/4" EK
6A0093I100513A	13	1"	3/4" EK

AC00.70G ISOLANTE PER DOPPIO COLLETTORE IN ACCIAIO
INOX
*INSULATION FOR STAINLESS STEEL STAINLESS
STEEL MANIFOLDS*



CODICE

AC0070GIC6760H

Doppi gusci adesivizzati in poliuretano, 21kg/m3 per isolare sino a 13 attacchi (per collettori più corti si taglia), completo di 4 chiusure isolanti laterali e fori per inserimento termometri.

Adhesive-backed polyurethane double shells, 21kg/m3 to insulate up to 13 connections (for shorter manifold, please cut it), complete with 4 side insulation closures and holes for thermometer insertion.

6100.35 TERMOSTATO DI SICUREZZA
SAFETY THERMOSTAT



CODICE

610035HSITERMH

6100.M2 0H VALVOLA A SFERA M/F A PASSAGGIO TOTALE SEDE
PIANA CON FARFALLA
*M/F FULL PORT BALL VALVE FLAT SEAT WITH
BUTTERFLY*



CODICE

6100M2N101000H



1" (Ø 25MM)

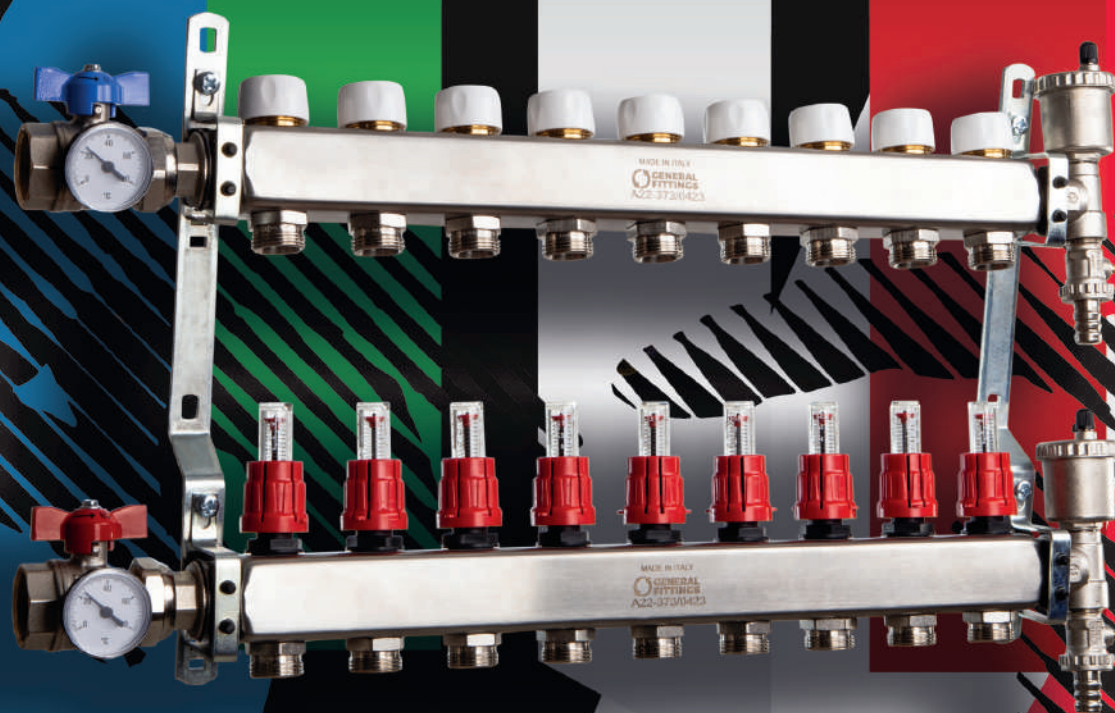

THOR

COLLETTORI IN ACCIAIO INOX
STAINLESS STEEL MANIFOLDS



ODINO

SERIE 6500

LINE 6500

Collettori di distribuzione in ottone

Brass distribution manifolds

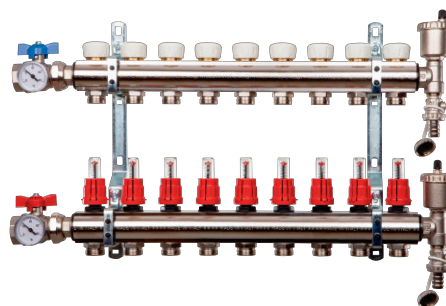

I collettori ODINO (SERIE 6500) con uscite da 3/4" Eurocono sono la soluzione ideale per la distribuzione di acqua in impianti di riscaldamento e raffrescamento radiante.

I collettori sono premontati su staffe e sono disponibili con barre di mandata e ritorno da 1" e 1"1/4, possono essere alloggiati in cassette di metallo e posizionati nelle pareti divisorie.

Numerosi accessori permettono di completare il collettore con tutti i componenti necessari al funzionamento dell'impianto: valvole a sfera di intercettazione, valvole di sfiato, valvole by pass, rubinetti di carico-scarico.

LINE 6500 manifolds with 3/4" connecions are suitable for the realization of underfloor heating and cooling radiant systems.

Manifolds are preassembled on brackets. Delivery and return manifolds are available from 1" to 1"1/4. Manifolds can be housed in metal cases and placed in the walls. A wide range of accessories makes it possible to complete the manifold with all the necessary components for the proper functioning of the system: shut-off ball valves, venting valves, bypass valves and input/output taps.







VANTAGGI

- Bilanciamento di ogni derivazione
- No ad inutili sprechi
- Elevato comfort tecnico
- Utilizzabili in impianti sia a bassa che ad alta temperatura

ADVANTAGES

- *Balancing of each loop*
- *No unnecessary waste*
- *High technical comfort*
- *Suitable both for high and low temperature installations*

APPLICAZIONI E PRESTAZIONI FIELDS OF APPLICATION

APPLICAZIONI APPLICATIONS	T. min. con vitone T. min with mechanical screw	T. min. con flussimetro T. min with flow meter	T. max con vitone T. max with mechanical screw	T. max con flussimetro T. max with flow meter	Press. max con vitone Press. max with mechanical screw	Press. max con flussimetro Press. max with flow meter	Portata con flussimetro Flow rate with flow meter
 riscaldamento a pavimento low temperature heating (floor)	-20°C	-7°C	+95°C	+65°C	10 bar	6 bar	0.5 lt/min
 riscaldamento a parete low temperature heating (wall)	-20°C	-7°C	+95°C	+65°C	10 bar	6 bar	0.5 lt/min
 riscaldamento a soffitto low temperature heating (ceiling)	-20°C	-7°C	+95°C	+65°C	10 bar	6 bar	0.5 lt/min
 radiatori radiators	-20°C	-7°C	+95°C	+65°C	10 bar	6 bar	0.5 lt/min
 raffreddamento cooling	-20°C	-7°C	+95°C	+65°C	10 bar	6 bar	0.5 lt/min
 -20°C: solo con liquido antigelo, glicole, in % max del 30% -20°C: only with antifreeze liquid (glycol) in % max of 30%							



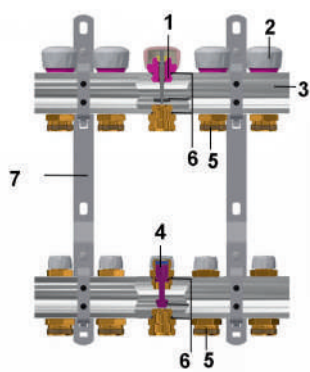



COMPONENTI E MATERIALI 6500.93 COMPONENTS AND MATERIALS: 6500.93

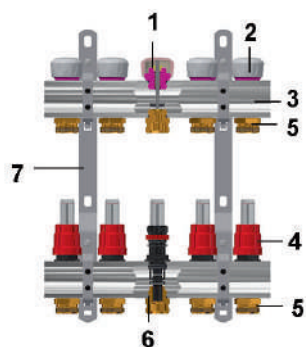







LEGENDA LEGEND	COMPONENTI COMPONENTS	MATERIALI MATERIALS
1	Vitone Headwork	CW617N - UNI EN 12164 Brass CW617N - UNI EN 12164
2	Manopola Knob	ABS
3	Collettore Manifold	CW617N - UNI EN 12165 Brass CW617N - UNI EN 12165
4	Detentore Lockshield	CW617N - UNI EN 12164 Brass CW617N - UNI EN 12164
5	Nippli Connecting Nipples	CW617N - UNI EN 12165 Brass CW617N - UNI EN 12165
6	O-Ring	Elastomero Elastomer
7	Staffe Brackets	FE ZNB

COMPONENTI E MATERIALI 6500.71-6500.72-6500.H6 COMPONENTS AND MATERIALS: 6500.71-6500.72-6500.H6



LEGENDA LEGEND	COMPONENTI COMPONENTS	MATERIALI MATERIALS
	1 Vitone Mechanical balancing screw	CW617N - UNI EN 12164 Brass CW617N - UNI EN 12164
	2 Manopola Knob	ABS
	3 Collettore Manifold	CW603 - UNI EN 12164
	4 Flussimetri Flow meter	PLASTICA PLASTIC PA66
	5 Nippli Connecting Nipples	CW617N - UNI EN 12165 Brass CW617N - UNI EN 12165
	6 O-Ring	Elastomero Elastomer
	7 Staffe Brackets	FE ZNB

CERTIFICAZIONI CERTIFICATIONS

STATO COUNTRY	CERTIFICAZIONE CERTIFICATION	STATO COUNTRY	CERTIFICAZIONE CERTIFICATION	STATO COUNTRY	CERTIFICAZIONE CERTIFICATION
					
					

NORMATIVE

- UNI EN ISO 228-1
Filettatura di tubazioni per accoppiamento non a tenuta sul filetto

REGULATIONS

- UNI EN ISO 228-1:2003
Threads complies with UNI EN ISO 228-1:2003 law: "Piping thread for coupling not with tightness on the thread"

FLUSSIMETRI

Funzione "memory-stop" flussimetro.
Sistema di bloccaggio del grado di apertura del flussimetro che consente, alla riapertura del circuito, l'arresto della corsa nella impostazione iniziale (valore di progetto).

FLOWMETER "MEMORY - STOP" FUNCTION

*Funzione "memory-stop" flussimetro.
Blocking system of the opening grade of the flowmeter which allows, once the system is reopened, the stopping of the run at its initial setting (project value).*

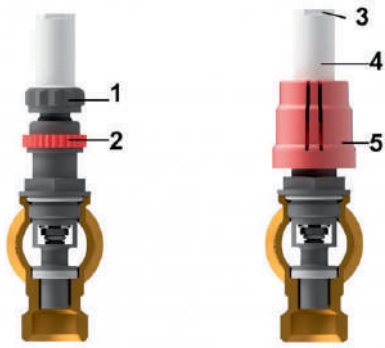

LEGENDA LEGEND	COMPONENTI COMPONENTS
1	Ghiera regolazione Regulation ring
2	Ghiera memory stop Memory stop ring
3	Esagono bicchiere Glass hexagon part
4	Bicchiere Glass
5	Volantino Control

1) Impostare la regolazione del flussimetro a valore di progetto. Il volantino, durante questa operazione, deve essere tolto;

2) Avvitare la ghiera di "Memory-Stop" in senso antiorario (filettatura sinistra) fino ad arrivare a fine corsa;

3) Riposizionare il volantino. Agendo sul volantino (ruotando in senso orario) è possibile chiudere il singolo circuito. Ruotando in senso contrario fino al suo bloccaggio, è possibile riaprire il circuito, fino a valore di progetto impostato.

Tramite le due asole presenti sul volantino è possibile piombare il Flussimetro, onde evitarne la manomissione della regolazione impostata.

Attenzione: NON utilizzare attrezzi per la manovra/regolazione del flussimetro, onde pregiudicarne il corretto funzionamento del flussimetro stesso.

1) Set the Flowmeter control to the design value. The control wheel must be removed during this operation.

2) Turn the "Memory stop" ferrule anticlockwise (left-hand thread) to the end of its travel.

3) Put the control wheel back on. The individual circuit can be closed by turning the wheel clockwise. By turning it the other way up to the stop it is possible to reopen the circuit to the set design value.

Using the two holes in the control wheel it is possible to seal the Flowmeter so as to prevent tampering with the setting.

Warning: do NOT use any tools to turn/manipulate the Flowmeter, as to do so could stop it working properly.

FLUSSIMETRO 0.5 L FLOWMETER 0.5 L		
DP Pa	DP kpa	Q l/h
10	0.01	8
100	0.1	25
500	0.5	60
1000	1	82
5000	5	185
10000	10	260
20000	20	365
30000	30	450
40000	40	520
50000	50	585
60000	60	640
70000	70	690
80000	80	740
90000	90	785
100000	100	825

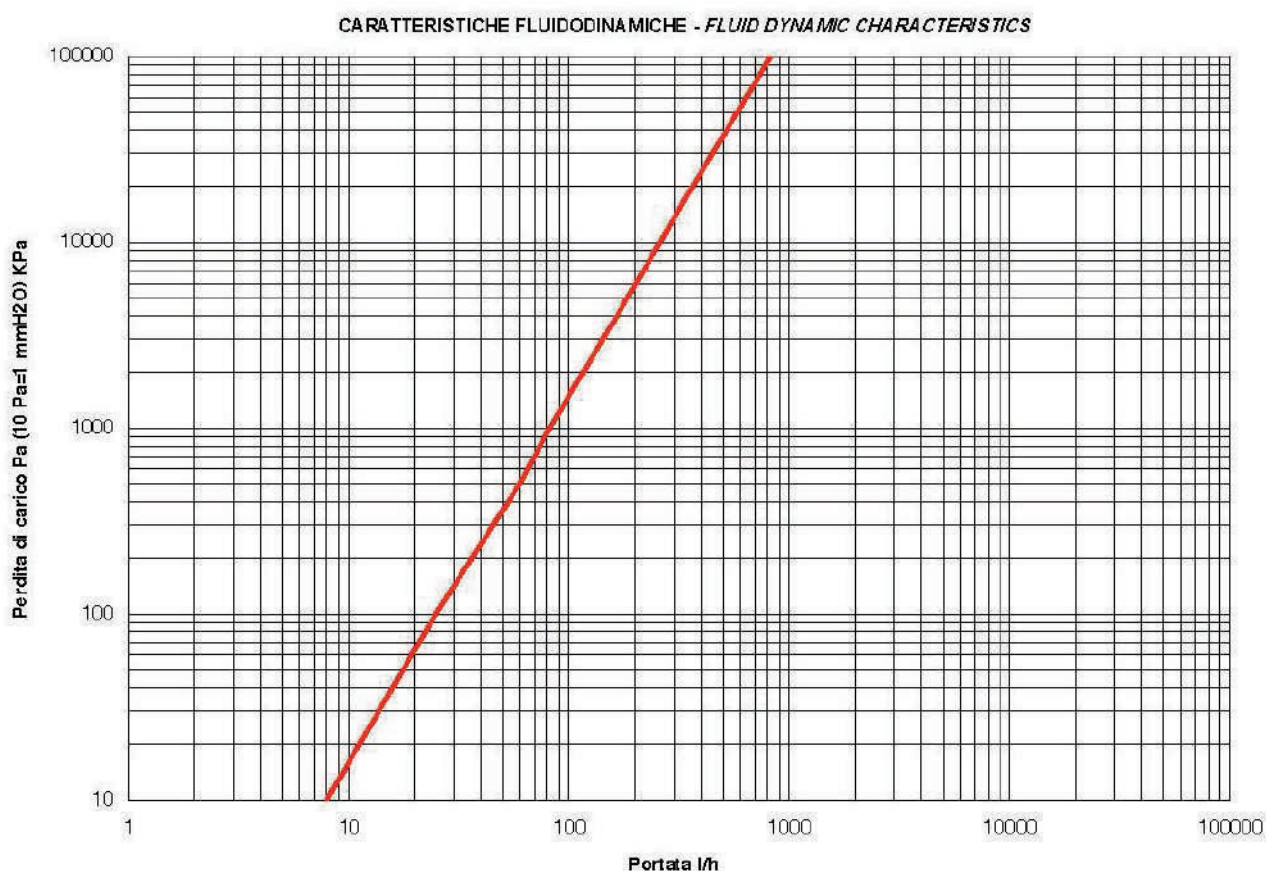

ISTRUZIONI DI MANUTENZIONE

Il bicchiere può essere smontato ed ispezionato per una eventuale pulizia anche con impianto funzionante.

- 1) Chiudere il flussimetro ruotando l'anello, non prima di aver registrato il bilanciamento (l/min) dell'impianto
- 2) Con l'ausilio di una chiave esagonale svitare il bicchiere agendo sulla struttura esagonale dello stesso
- 3) Procedere alla pulizia del bicchiere
- 4) Riavvitare il bicchiere nella posizione originale, bilanciando nuovamente l'impianto.

MAINTENANCE INSTRUCTIONS

The glass can be disassembled in order to check its cleanliness, even when the installation is working.

- 1) Close the flow meter turning the ring, but not before than having recorded the installation balancing (l/min)
- 2) With the help of a hexagonal wrench, unscrew the glass by acting on the hexagonal structure of the glass
- 3) Clean the glass
- 4) Re-insert the glass in its original position, balancing again the installation

BILANCIAMENTO MECCANICO DELL'IMPIANTO

I misuratori di portata (o flussimetri) e i detentori a memoria meccanica (detentori) sono situati sulla mandata del circuito, in questo modo è possibile stabilire il valore della portata teorica dell'impianto idraulico, tramite la regolazione dei misuratori/regolatori, che sarà

MECHANICAL BALANCING OF THE INSTALLATION

Flow measuring devices (flow meters) are located on the delivery circuit, making it possible to establish the theoretical flow value of the hydraulic system through the adjustment of the meters/regulators, which will be carried out by the installation technician.

effettuata del tecnico installatore.
Tale regolazione si deve compiere con la valvola in posizione di ritorno totalmente aperta.
Accertato che le portate di ogni circuito idraulico determinano una perdita di carico dell'impianto, è fondamentale che le regolazioni siano eseguite manualmente per tutti gli anelli dei misuratori, fino a raggiungere i valori di portata in l/ min determinati dal progetto.

*You have to adjust it when the valve is in the back-draft position and completely open.
Given that the flow of each plumbing circuit causes a loose in installation capacity, for each ring of the flow meter is basic that the adjustment are made by hand until you reach flow value in litre/minutes decided by the plan.*

DETENTORI (vitoni a memoria meccanica)

Istruzioni di regolazione dei collettori con detentori:

- Svitare il tappo
- Con la chiave a brugola avvitare l'otturatore fino a raggiungere la posizione di chiusura
- Il detentore è pronto per essere regolato come da tabella sottostante
- Utilizzare la ghiera per creare un fine corsa meccanico, avvitandola a battuta sull'otturatore una volta impostata la portata desiderata. In questo modo è possibile aprire e chiudere l'otturatore senza perdere la regolazione impostata.

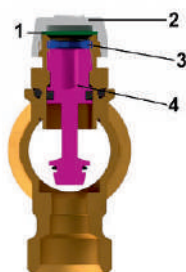

LOCKSHIELDS (mechanical memory stem)

Calibration instructions for manifolds with lockshields:

- *Unscrew the cap*
- *Using a hex key, tighten the cut-off valve until it's completely closed*
- *The lockshield is ready to be adjusted as per the chart below*
- *Use the closing ring to create a mechanical stop, tightening it down to the cut-off valve once the desired flow has been set. By so doing, the cut-off valve can be opened and closed without altering the set calibration.*

LEGENDA LEGEND	COMPONENTI COMPONENTS
1	Guarnizione Gasket
2	Tappo Cap
3	Ghiera Closing ring
4	Otturatore Cut off valve

Posizione Position	N° giri N° turns	Kvs (m ³ /h)
1	1/2	0.09
2	1	0.27
3	1+1/2	0.73
4	2	0.91
5	2+1/2	1.08
6	3	1.26
7	3+1/2	1.41
8	4	1.53
9	4+1/2	1.65
10	5	1.76
11	5+1/2	1.85
12	tutto aperto completely open	1.92

PROTEZIONE DEL BILANCIAMENTO IDRAULICO CONTRO LE MANOMISSIONI

La regolazione dei regolatori e dei misuratori di portata può essere bloccata con un coperchio di arresto, eventualmente piombato.

PROTECTING HYDRAULIC BALANCING FROM TAMPERING

Adjustment of the flow regulators and meters can be blocked by a protective cover, sealed if necessary.

Valvole di intercettazione predisposte per comando elettrotermico Pre-set shut-off valves for electrothermal command

1. Svitare la manopola di protezione
2. Posizionare la testa termoelettrica sulla valvola
3. Avvitare a mano la ghiera metallica (filettatura M30x1.5)
4. Eseguire i collegamenti elettrici

1. *Unscrew the protection handle*
2. *Place the electrothermal head on the valve*
3. *Tighten the metal closing ring by hand (threading: M30x1.5)*
4. *Complete the electrical connections*

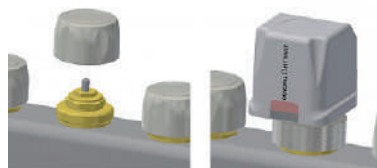

COMPONENTI: 6500.71 COMPONENTS: 6500.71

Collettore di distribuzione composto da:

- Collettore di mandata completo di flussimetri e nippi con derivazione 3/4" Eurocono
- Collettore di ritorno completo di valvole di intercettazione predisposte per comando elettrotermico
- Derivazioni 3/4" Eurocono
- Staffe di fissaggio

Manifold composed of:

- *Delivery manifold complete with flow meters and nipples with 3/4" Eurocone connectors*
- *Return manifold complete with pre-arranged shut-off valves for electrothermal command*
- *3/4" Eurocone adapters*
- *Brackets*

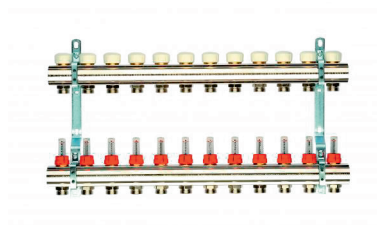

CONNESSIONI 6500.71 CONNECTIONS: 6500.71

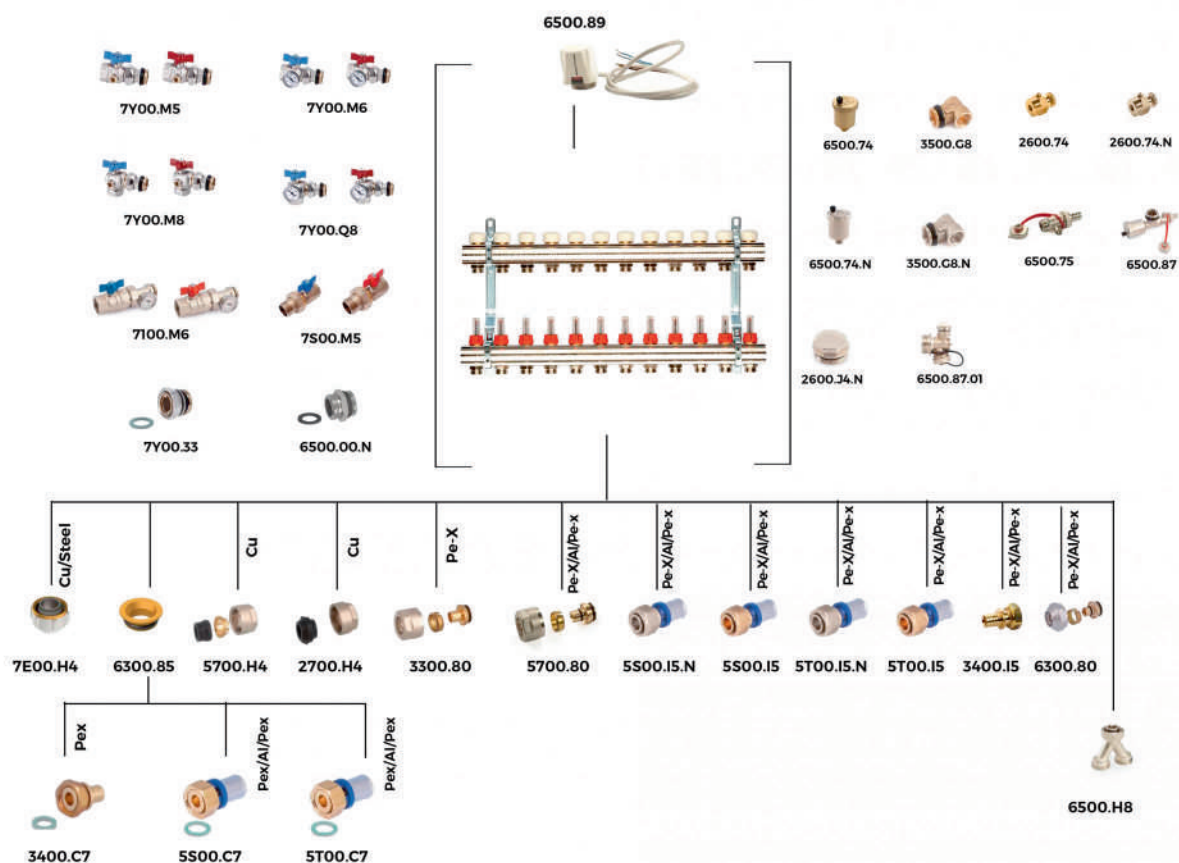

INSERTI E RACCORDI INSERTS AND FITTINGS

CODICE CODE	DESCRIZIONE DESCRIPTION	TUBO PIPE
7Y00.M5	Valvola a sfera compatta bocchettone con farfalla senza termometro Compact ball valve coupling with butterfly, without thermometer	
7Y00.M6	Valvola a sfera compatta bocchettone con farfalla con termometro Compact 90-degree ball valve coupling with butterfly and thermometer	
7Y00.M8	Valvola a sfera compatta a squadra bocchettone con farfalla senza termometro Compact 90-degree ball valve coupling with butterfly, no thermometer	
7Y00.Q8	Valvola a sfera compatta a squadra bocchettone con farfalla con termometro Compact 90-degree ball valve coupling with butterfly, no thermometer	
7100.M6	Valvola a sfera con termometro Ball valve with thermometer	
7500.M5	Valvola a sfera con bocchettone Manifold ball valve	
6500.74	Valvola di sfianto automatica Automatic air vent valve	

INSERTI E RACCORDI INSERTS AND FITTINGS		
6500.74.N	Valvola di sfiato automatica nichelata Nickel plated automatic air vent valve	
3500.G8	Finale per collettore End piece for manifold	
3500.G8.N	Finale per collettore nichelato Nickel plated end piece for manifold	
2600.74	Rubinetto sfiato calorifero tenuta O-Ring Air outlet valve with O-Ring	
2600.74.N	Rubinetto sfiato calorifero tenuta O-Ring nichelato Nickel plated air outlet valve with O-Ring	
6500.75	Rubinetto carico/scarico Charge/Discharge valve	
6500.87	Kit terminale per collettore nichelato automatico Automatic manifold terminal kit	Tubo rame/acciaio Copper/Steel pipe
6500.87.01	Kit terminale per collettore nichelato manuale Manual manifold terminal kit	Tubo Pe-X Pe-X pipe
2600.J4.N	Tappo maschio nichelato con O-Ring Male cup with O-Ring	Tubo multistrato Multilayer pipe
6300.80	Dado nichelato, ogiva e inserto eurocono Nickel plated nut, olive and insert eurocone	Tubo multistrato Multilayer pipe
6300.85	Adattatore sede piana eurocono Eurocone flat seal adapter	Tubo rame Copper pipe
7E00.H4	Kit eurocono nichelato Nickel plated eurokonus kit	Tubo Pe-X Pe-X pipe
5700.H4	Dado nichelato con ogiva e guarnizione inclusa Nickel plated nut with assembled ring and gasket	Tubo multistrato Multilayer pipe
2700.H4	Dado nichelato con ogiva e guarnizione inclusa Nickel plated nut with assembled ring and gasket	Tubo multistrato Multilayer pipe
3300.80	Dado nichelato, ogiva e inserto eurocono Nickel plated nut, olive and insert eurocone	Tubo multistrato Multilayer pipe
5700.80	Dado nichelato, ogiva e inserto eurocono Nickel plated nut, olive and insert eurocone	
5500.I5	Raccordo dritto sede conica O-Ring con girello- Straight fitting with loose nut and conical connection	Tubo multistrato Multilayer pipe
5500.I5.N	Raccordo dritto nichelato sede conica O-Ring con girello- Nickel-plated straight fitting with loose nut and conical connection	Tubo multistrato Multilayer pipe
5T00.I5	Raccordo dritto sede conica O-Ring con girello- Straight fitting with loose nut and conical connection	Tubo multistrato Multilayer pipe
5T00.I5.N	Raccordo dritto nichelato sede conica O-Ring con girello- Nickel-plated straight fitting with loose nut and conical connection	Tubo multistrato Multilayer pipe
3400.I5	Raccordo diritto eurocono con girello Straight fitting with loose nut and eurocone connection	tubo Pe-X Pe-X pipe
6500.H8	Raccordo sdoppiatore nichelato Eurocone nickel plated splitter	
3400.C7	Raccordo diritto sede piana con girello Straight fitting with loose nut and flat washer	Tubo Pe-X Pe-X pipe
5500.C7	Raccordo diritto sede piana con girello Straight fitting with loose nut and flat washer	Tubo multistrato Multilayer pipe
5T00.C7	Raccordo diritto sede piana con girello Straight fitting with loose nut and flat washer	Tubo multistrato Multilayer pipe

INSERTI E RACCORDI INSERTS AND FITTINGS		
6500.00.N	Raccordo m/m con o-ring e guarnizione piatta Male fitting with o-ring and flat gasket	
7Y00.33	Raccordo collettore nichelato Nickel-plated manifold fitting	

DIMENSIONI 6500.71 6500.71 DIMENSIONS

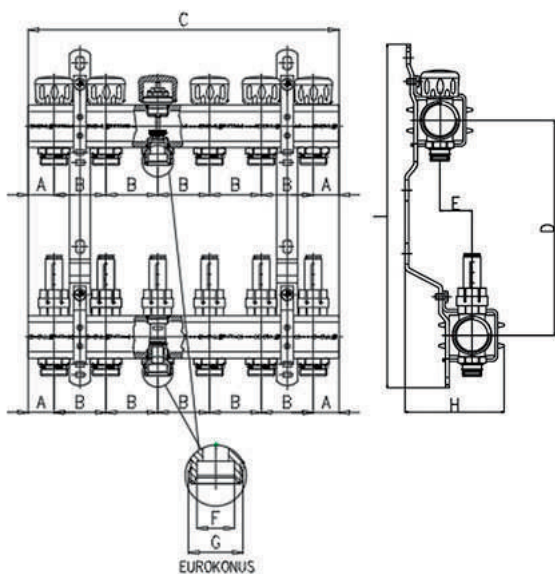

CODICE CODE	A	B	C	D	E***	F	G	H*	H**	I	VIE	MISUR E TUBO
650071N100502A	25	50	100	200	3/18	18.1	3/4"	89	76	319	2	1"-3/4" Ek.
650071N100503A	25	50	150	200	3/18	18.1	3/4"	89	76	319	3	1"-3/4" Ek.
650071N100504A	25	50	200	200	3/18	18.1	3/4"	89	76	319	4	1"-3/4" Ek.
650071N100505A	25	50	250	200	3/18	18.1	3/4"	89	76	319	5	1"-3/4" Ek.
650071N100506A	25	50	300	200	3/18	18.1	3/4"	89	76	319	6	1"-3/4" Ek.
650071N100507A	25	50	350	200	3/18	18.1	3/4"	89	76	319	7	1"-3/4" Ek.
650071N100508A	25	50	400	200	3/18	18.1	3/4"	89	76	319	8	1"-3/4" Ek.
650071N100509A	25	50	450	200	3/18	18.1	3/4"	89	76	319	9	1"-3/4" Ek.
650071N100510A	25	50	500	200	3/18	18.1	3/4"	89	76	319	10	1"-3/4" Ek.
650071N100511A	25	50	550	200	3/18	18.1	3/4"	89	76	319	11	1"-3/4" Ek.
650071N100512A	25	50	600	200	3/18	18.1	3/4"	89	76	319	12	1"-3/4" Ek.
650071N100513A	25	50	650	200	3/18	18.1	3/4"	89	76	319	13	1"-3/4" Ek.
650071N120502A	30	50	110	200	3/18	18.1	3/4"	99	86	319	2	1"1/4-3/4" Ek.
650071N120503A	30	50	160	200	3/18	18.1	3/4"	99	86	319	3	1"1/4-3/4" Ek.
650071N120504A	30	50	240	200	3/18	18.1	3/4"	99	86	319	4	1"1/4-3/4" Ek.
650071N120505A	30	50	260	200	3/18	18.1	3/4"	99	86	319	5	1"1/4-3/4" Ek.
650071N120506A	30	50	310	200	3/18	18.1	3/4"	99	86	319	6	1"1/4-3/4" Ek.
650071N120507A	30	50	360	200	3/18	18.1	3/4"	99	86	319	7	1"1/4-3/4" Ek.
650071N120508A	30	50	410	200	3/18	18.1	3/4"	99	86	319	8	1"1/4-3/4" Ek.
650071N120509A	30	50	460	200	3/18	18.1	3/4"	99	86	319	9	1"1/4-3/4" Ek.
650071N120510A	30	50	510	200	3/18	18.1	3/4"	99	86	319	10	1"1/4-3/4" Ek.
650071N120511A	30	50	560	200	3/18	18.1	3/4"	99	86	319	11	1"1/4-3/4" Ek.
650071N120512A	30	50	610	200	3/18	18.1	3/4"	99	86	319	12	1"1/4-3/4" Ek.

CODICE CODE	A	B	C	D	E***	F	G	H*	H**	I	VIE	MISUR E TUBO
----------------	---	---	---	---	------	---	---	----	-----	---	-----	--------------------

* staffa standard già montata (H= 89 per collettori da 1" ; H=99 per collettori da 1"1/4) per utilizzo su cassetta di profondità 110 (AC0080I500000A / AC0080I700000A / AC0080I100000A)

** staffa opzionale, non presente nella confezione (H= 76 per collettori da 1" ; H=86 per collettori da 1"1/4), per utilizzo su cassetta di profondità 90 (AC0080I550090A / AC0080I700090A / AC0080I850090A / AC0080I100090A) e su cassetta di profondità 110 (AC0080I500000A / AC0080I700000A / AC0080I100000A)

***staffa standard/staffa opzionale

* *standard bracket already assembled (H= 89 for manifolds of 1" ; H=99 for manifolds of 1"1/4) for use with 110 depth case (AC0080I500000A / AC0080I700000A / AC0080I100000A)*

** *Optional bracket, not present in the package (H= 76 for manifolds of 1" ; H=86 for manifolds of 1"1/4), for use with 90 depth case (AC0080I550090A / AC0080I700090A / AC0080I850090A / AC0080I100090A) and 110 depth case (AC0080I500000A / AC0080I700000A / AC0080I100000A)*

****standard/optional bracket*

COMPONENTI 6500.72 COMPONENTS: 6500.72

Collettore di distribuzione composto da:

- Collettore di mandata completo di flussimetri e nippoli
- Collettore di ritorno completo di valvole di intercettazione predisposte per comando elettrotermico
- Derivazioni 3/4" Eurocono
- Valvole automatiche di sfogo aria e rubinetti carico/scarico
- Valvole a sfera con termometro
- Staffe di fissaggio

Manifold composed of:

- *Delivery manifold with flow meters and nipples*
- *Return manifold complete with pre-arranged shut-off valves for electrothermal command*
- *3/4" Eurocone adapters*
- *Automatic air vent valves and charge/discharge valves*
- *Ball valves with thermometer*
- *Brackets*

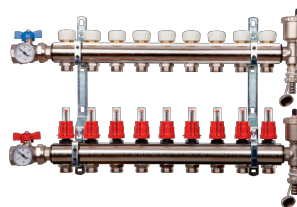

CONNESSIONI 6500.72
CONNECTIONS: 6500.72

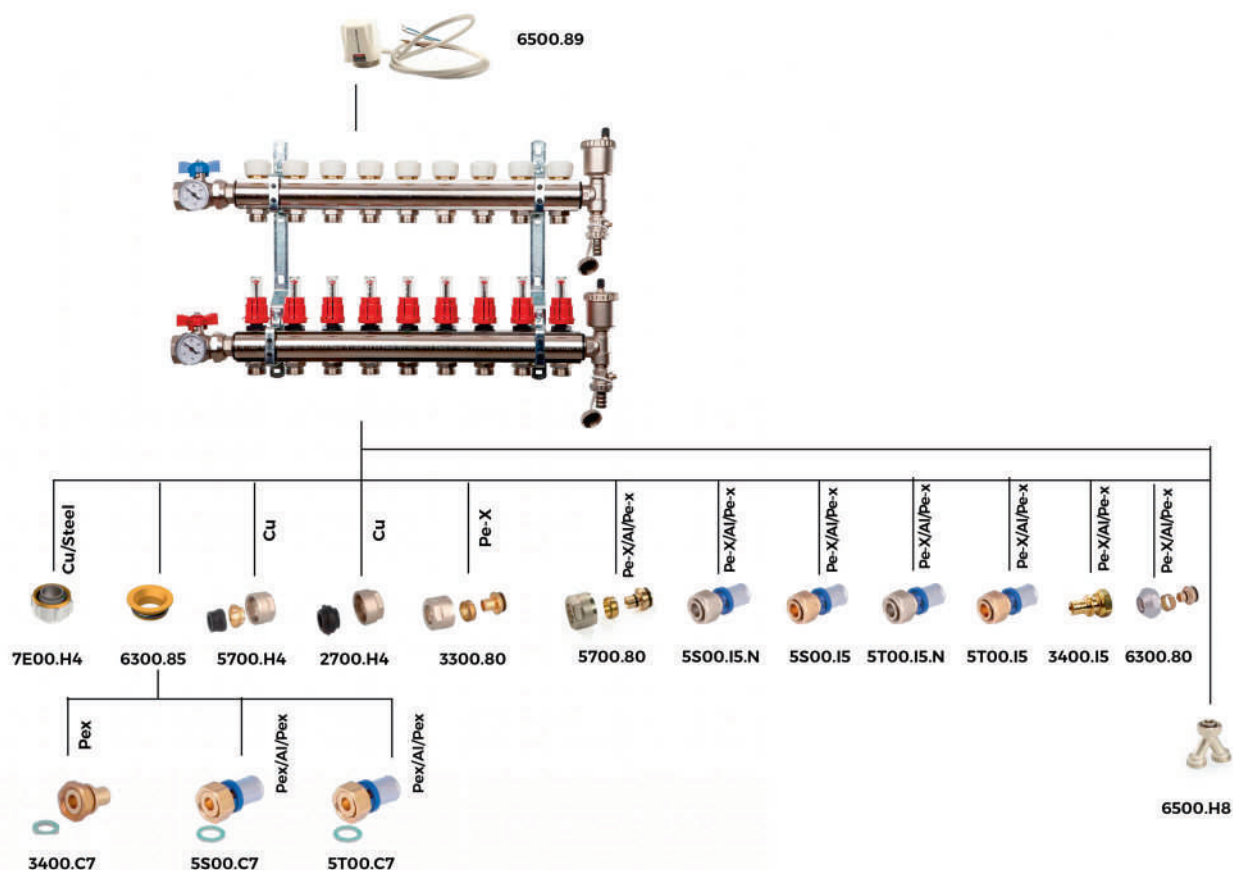

INSERTI E RACCORDI
INSERTS AND FITTINGS

CODICE CODE	DESCRIZIONE DESCRIPTION	TUBO PIPE
6500.89	Comandi elettrotermici Electrothermic control	
6300.80	Dado nichelato, ogiva e inserto eurocono Nickel plated nut, olive and insert eurocone	Tubo multistrato Multilayer pipe
6300.85	Adattatore sede piana eurocono Eurocone flat seal adapter	Tubo rame Copper pipe
7E00.H4	Kit eurocono nichelato	Tubo Pe-X Pe-X pipe
5700.H4	Dado nichelato con ogiva e guarnizione inclusa Nickel plated nut with assembled ring and gasket	Tubo multistrato Multilayer pipe
2700.H4	Dado nichelato con ogiva e guarnizione inclusa Nickel plated nut with assembled ring and gasket	Tubo multistrato Multilayer pipe
3300.80	Dado nichelato, ogiva e inserto eurocono Nickel plated nut, olive and insert eurocone	Tubo multistrato Multilayer pipe
5700.80	Dado nichelato, ogiva e inserto eurocono Nickel plated nut, olive and insert eurocone	
5500.I5	Raccordo dritto sede conica O-Ring con girello- Straight fitting with loose nut and conical connection	Tubo multistrato Multilayer pipe

INSERTI E RACCORDI INSERTS AND FITTINGS		
5500.I5.N	Raccordo dritto nichelato sede conica O-Ring con girello- Nickel-plated straight fitting with loose nut and conical connection	Tubo multistrato Multilayer pipe
5T00.I5	Raccordo dritto sede conica O-Ring con girello- Straight fitting with loose nut and conical connection	Tubo multistrato Multilayer pipe
5T00.I5.N	Raccordo dritto nichelato sede conica O-Ring con girello- Nickel-plated straight fitting with loose nut and conical connection	Tubo multistrato Multilayer pipe
3400.I5	Raccordo diritto eurocono con girello Straight fitting with loose nut and eurocone connection	tubo Pe-X Pe-X pipe
6500.H8	Raccordo sdoppiatore nichelato Eurocone nickel plated splitter	
3400.C7	Raccordo diritto sede piana con girello Straight fitting with loose nut and flat washer	Tubo Pe-X Pe-X pipe
5500.C7	Raccordo diritto sede piana con girello Straight fitting with loose nut and flat washer	Tubo multistrato Multilayer pipe
5T00.C7	Raccordo diritto sede piana con girello Straight fitting with loose nut and flat washer	Tubo multistrato Multilayer pipe

DIMENSIONI 6500.72 6500.72: DIMENSIONS

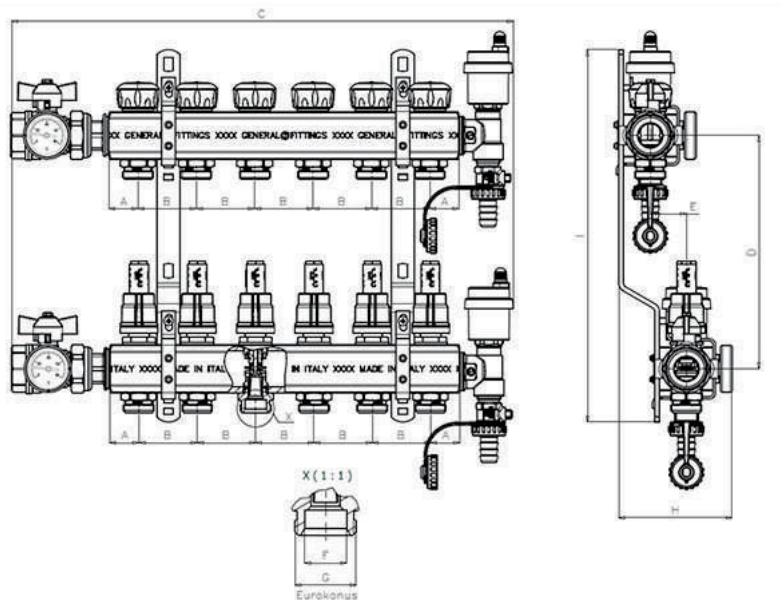

CODICE CODE	A	B	C	D	E***	F	G	H*	H**	I	VIE	Ø TUBO
650072N100502A	25	50	230	200	3/18	18.1	3/4"	97	76	367	2	1"-3/4" Ek.
650072N100503A	25	50	280	200	3/18	18.1	3/4"	97	76	367	3	1"-3/4" Ek.
650072N100504A	25	50	330	200	3/18	18.1	3/4"	97	76	367	4	1"-3/4" Ek.
650072N100505A	25	50	380	200	3/18	18.1	3/4"	97	76	367	5	1"-3/4" Ek.
650072N100506A	25	50	430	200	3/18	18.1	3/4"	97	76	367	6	1"-3/4" Ek.
650072N100507A	25	50	480	200	3/18	18.1	3/4"	97	76	367	7	1"-3/4" Ek.
650072N100508A	25	50	530	200	3/18	18.1	3/4"	97	76	367	8	1"-3/4" Ek.
650072N100509A	25	50	580	200	3/18	18.1	3/4"	97	76	367	9	1"-3/4" Ek.
650072N100510A	25	50	630	200	3/18	18.1	3/4"	97	76	367	10	1"-3/4" Ek.
650072N100511A	25	50	680	200	3/18	18.1	3/4"	97	76	367	11	1"-3/4" Ek.
650072N100512A	25	50	730	200	3/18	18.1	3/4"	97	76	367	12	1"-3/4" Ek.
650072N100513A	25	50	780	200	3/18	18.1	3/4"	97	76	367	13	1"-3/4" Ek.
650072N120502A	30	50	302	200	3/18	18.1	3/4"	99	86	357	2	1"1/4-3/4" Ek.
650072N120503A	30	50	352	200	3/18	18.1	3/4"	99	86	357	3	1"1/4-3/4" Ek.
650072N120504A	30	50	402	200	3/18	18.1	3/4"	99	86	357	4	1"1/4-3/4" Ek.
650072N120505A	30	50	452	200	3/18	18.1	3/4"	99	86	357	5	1"1/4-3/4" Ek.
650072N120506A	30	50	502	200	3/18	18.1	3/4"	99	86	357	6	1"1/4-3/4" Ek.
650072N120507A	30	50	552	200	3/18	18.1	3/4"	99	86	357	7	1"1/4-3/4" Ek.
650072N120508A	30	50	602	200	3/18	18.1	3/4"	99	86	357	8	1"1/4-3/4" Ek.
650072N120509A	30	50	652	200	3/18	18.1	3/4"	99	86	357	9	1"1/4-3/4" Ek.
650072N120510A	30	50	702	200	3/18	18.1	3/4"	99	86	357	10	1"1/4-3/4" Ek.
650072N120511A	30	50	752	200	3/18	18.1	3/4"	99	86	357	11	1"1/4-3/4" Ek.
650072N120512A	30	50	802	200	3/18	18.1	3/4"	99	86	357	12	1"1/4-3/4" Ek.

* staffa standard già montata (H= 89 per collettori da 1" ; H=99 per collettori da 1"1/4) per utilizzo su cassetta di profondità 110 (AC0080I500000A / AC0080I700000A / AC0080I100000A)

** staffa opzionale, non presente nella confezione (H= 76 per collettori da 1" ; H=86 per collettori da 1"1/4), per utilizzo su cassetta di profondità 90 (AC0080I550090A / AC0080I700090A / AC0080I850090A / AC0080I100090A) e su cassetta di profondità 110 (AC0080I500000A / AC0080I700000A / AC0080I100000A)

***staffa standard/staffa opzionale

* *standard bracket already assembled (H= 89 for manifolds of 1" ; H=99 for manifolds of 1"1/4) for use with 110 depth case (AC0080I500000A / AC0080I700000A / AC0080I100000A)*

** *Optional bracket, not present in the package (H= 76 for manifolds of 1" ; H=86 for manifolds of 1"1/4), for use with 90 depth case (AC0080I550090A / AC0080I700090A / AC0080I850090A / AC0080I100090A) and 110 depth case (AC0080I500000A / AC0080I700000A / AC0080I100000A)*

****standard/optional bracket*

COMPONENTI 6500.93 COMPONENTS: 6500.93

Collettore di distribuzione composto da:

- Collettore di mandata completo di vitoni a memoria meccanica
- Collettore di ritorno completo di valvole di intercettazione predisposte per comando elettrotermico
- Derivazioni 3/4" Eurocono
- Staffe di fissaggio

Manifold composed of:

- *Delivery manifold complete with mechanical memory stems*
- *Return manifold complete with pre-arranged shut-off valves for electrothermal command*
- *3/4" Eurocone adapters*
- *Brackets*

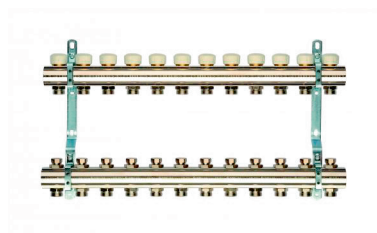

CONNESSIONI 6500.93 CONNECTIONS: 6500.93

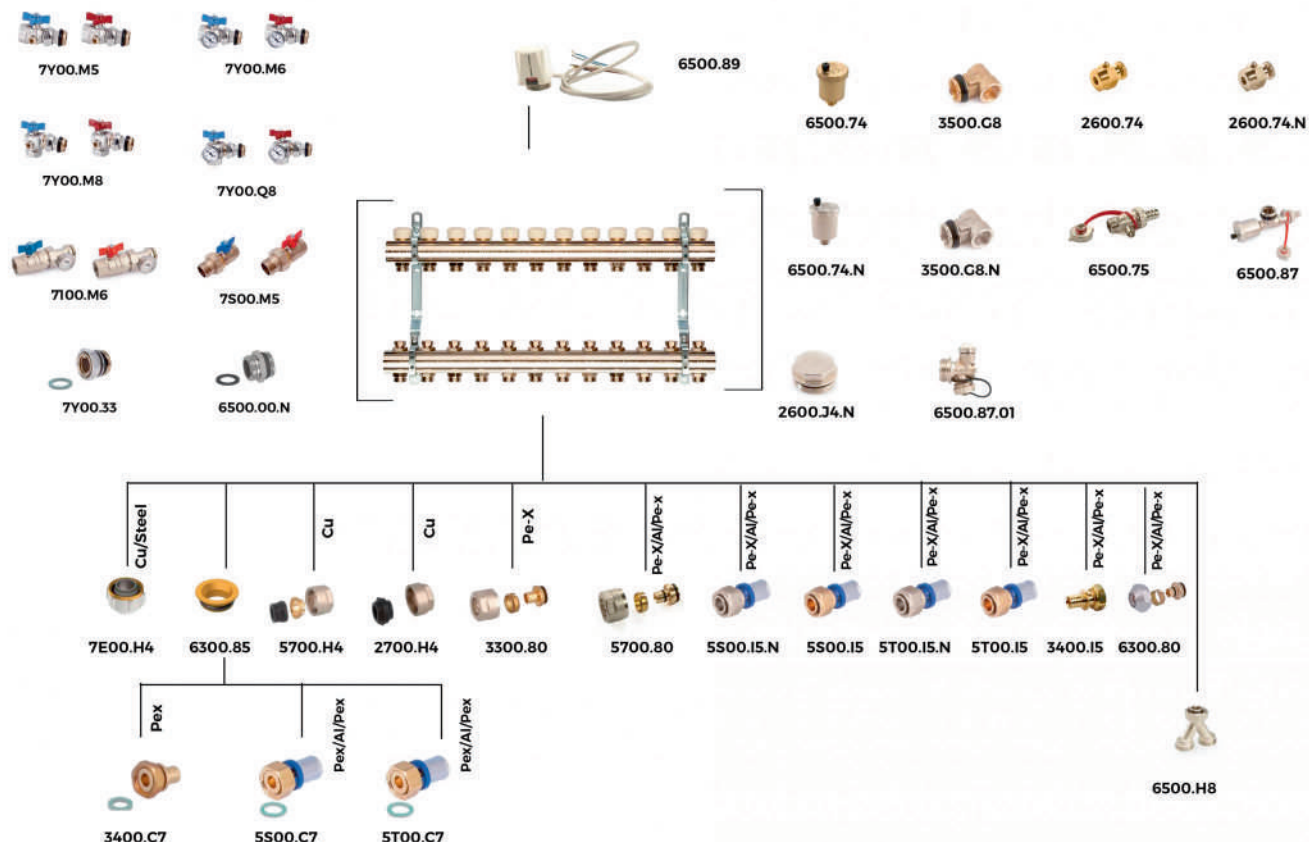

INSERTI E RACCORDI INSERTS AND FITTINGS

CODICE CODE	DESCRIZIONE DESCRIPTION	TUBO PIPE
7Y00.M5	Valvola a sfera compatta bocchettone con farfalla senza termometro Compact ball valve coupling with butterfly, without thermometer	
7Y00.M6	Valvola a sfera compatta bocchettone con farfalla con termometro Compact 90-degree ball valve coupling with butterfly and thermometer	
7Y00.M8	Valvola a sfera compatta a squadra bocchettone con farfalla senza termometro Compact 90-degree ball valve coupling with butterfly, no thermometer	
7Y00.Q8	Valvola a sfera compatta a squadra bocchettone con farfalla con termometro Compact 90-degree ball valve coupling with butterfly, no thermometer	
7100.M6	Valvola a sfera con termometro Ball valve with thermometer	
7500.M5	Valvola a sfera con bocchettone Manifold ball valve	
6500.74	Valvola di sfizio automatica Automatic air vent valve	

INSERTI E RACCORDI INSERTS AND FITTINGS		
6500.74.N	Valvola di sfiato automatica nichelata Nickel plated automatic air vent valve	
3500.G8	Finale per collettore End piece for manifold	
3500.G8.N	Finale per collettore nichelato Nickel plated end piece for manifold	
2600.74	Rubinetto sfiato calorifero tenuta O-Ring Air outlet valve with O-Ring	
2600.74.N	Rubinetto sfiato calorifero tenuta O-Ring nichelato Nickel plated air outlet valve with O-Ring	
6500.75	Rubinetto carico/scarico Charge/Discharge valve	
6500.87	Kit terminale per collettore nichelato automatico Automatic manifold terminal kit	Tubo rame/acciaio Copper/Steel pipe
6500.87.01	Kit terminale per collettore nichelato manuale Manual manifold terminal kit	Tubo Pe-X Pe-X pipe
2600.J4.N	Tappo maschio nichelato con O-Ring Male cup with O-Ring	Tubo multistrato Multilayer pipe
6300.80	Dado nichelato, ogiva e inserto eurocono Nickel plated nut, olive and insert eurocone	Tubo multistrato Multilayer pipe
6300.85	Adattatore sede piana eurocono Eurocone flat seal adapter	Tubo rame Copper pipe
7E00.H4	Kit eurocono nichelato	Tubo Pe-X Pe-X pipe
5700.H4	Dado nichelato con ogiva e guarnizione inclusa Nickel plated nut with assembled ring and gasket	Tubo multistrato Multilayer pipe
2700.H4	Dado nichelato con ogiva e guarnizione inclusa Nickel plated nut with assembled ring and gasket	Tubo multistrato Multilayer pipe
3300.80	Dado nichelato, ogiva e inserto eurocono Nickel plated nut, olive and insert eurocone	Tubo multistrato Multilayer pipe
5700.80	Dado nichelato, ogiva e inserto eurocono Nickel plated nut, olive and insert eurocone	
5500.I5	Raccordo dritto sede conica O-Ring con girello- Straight fitting with loose nut and conical connection	Tubo multistrato Multilayer pipe
5500.I5.N	Raccordo dritto nichelato sede conica O-Ring con girello- Nickel-plated straight fitting with loose nut and conical connection	Tubo multistrato Multilayer pipe
5T00.I5	Raccordo dritto sede conica O-Ring con girello- Straight fitting with loose nut and conical connection	Tubo multistrato Multilayer pipe
5T00.I5.N	Raccordo dritto nichelato sede conica O-Ring con girello- Nickel-plated straight fitting with loose nut and conical connection	Tubo multistrato Multilayer pipe
3400.I5	Raccordo diritto eurocono con girello Straight fitting with loose nut and eurocone connection	tubo Pe-X Pe-X pipe
6500.H8	Raccordo sdoppiatore nichelato Eurocone nickel plated splitter	
3400.C7	Raccordo diritto sede piana con girello Straight fitting with loose nut and flat washer	Tubo Pe-X Pe-X pipe
5500.C7	Raccordo diritto sede piana con girello Straight fitting with loose nut and flat washer	Tubo multistrato Multilayer pipe
5T00.C7	Raccordo diritto sede piana con girello Straight fitting with loose nut and flat washer	Tubo multistrato Multilayer pipe

INSERTI E RACCORDI
INSERTS AND FITTINGS

7Y00.33	Raccordo collettore nichelato Nickel-plated manifold fitting	
6500.00.N	Raccordo m/m con o-ring e guarnizione piatta Male fitting with o-ring and flat gasket	

DIMENSIONI 6500.93
DIMENSIONS: 6500.93

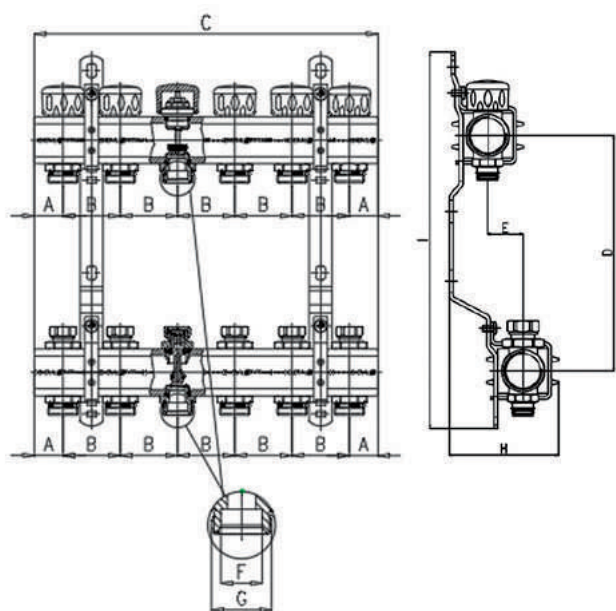

CODICE CODE	A	B	C	D	E***	F	G	H*	H**	I	VIE	Ø TUBO
650093N100502A	25	50	100	200	3/18	18.1	3/4"	89	76	319	2	1"-3/4" Ek.
650093N100503A	25	50	150	200	3/18	18.1	3/4"	89	76	319	3	1"-3/4" Ek.
650093N100504A	25	50	200		3/18	18.1	3/4"	89	76	319	4	1"-3/4" Ek.
650093N100505A	25	50	250	200	3/18	18.1	3/4"	89	76	319	5	1"-3/4" Ek.
650093N100506A	25	50	300	200	3/18	18.1	3/4"	89	76	319	6	1"-3/4" Ek.
650093N100507A	25	50	350	200	3/18	18.1	3/4"	89	76	319	7	1"-3/4" Ek.
650093N100508A	25	50	400	200	3/18	18.1	3/4"	89	76	319	8	1"-3/4" Ek.
650093N100509A	25	50	450	200	3/18	18.1	3/4"	89	76	319	9	1"-3/4" Ek.
650093N100510A	25	50	500	200	3/18	18.1	3/4"	89	76	319	10	1"-3/4" Ek.
650093N100511A	25	50	550	200	3/18	18.1	3/4"	89	76	319	11	1"-3/4" Ek.
650093N100512A	25	50	600	200	3/18	18.1	3/4"	89	76	319	12	1"-3/4" Ek.
650093N120502A	30	50	110	200	3/18	18.1	3/4"	99	86	319	2	1"1/4-3/4" Ek.
650093N120503A	30	50	160	200	3/18	18.1	3/4"	99	86	319	3	1"1/4-3/4" Ek.
650093N120504A	30	50	240	200	3/18	18.1	3/4"	99	86	319	4	1"1/4-3/4" Ek.
650093N120505A	30	50	260	200	3/18	18.1	3/4"	99	86	319	5	1"1/4-3/4" Ek.
650093N120506A	30	50	310	200	3/18	18.1	3/4"	99	86	319	6	1"1/4-3/4" Ek.
650093N120507A	30	50	360	200	3/18	18.1	3/4"	99	86	319	7	1"1/4-3/4" Ek.
650093N120508A	30	50	410	200	3/18	18.1	3/4"	99	86	319	8	1"1/4-3/4" Ek.
650093N120509A	30	50	460	200	3/18	18.1	3/4"	99	86	319	9	1"1/4-3/4" Ek.
650093N120510A	30	50	510	200	3/18	18.1	3/4"	99	86	319	10	1"1/4-3/4" Ek.
650093N120511A	30	50	560	200	3/18	18.1	3/4"	99	86	319	11	1"1/4-3/4" Ek.
650093N120512A	30	50	610	200	3/18	18.1	3/4"	99	86	319	12	1"1/4-3/4" Ek.

* staffa standard già montata (H= 89 per collettori da 1" ; H=99 per collettori da 1"1/4) per utilizzo su cassetta di profondità 110 (AC0080I500000A / AC0080I700000A / AC0080I100000A)

** staffa opzionale, non presente nella confezione (H= 76 per collettori da 1" ; H=86 per collettori da 1"1/4), per utilizzo su cassetta di profondità 90 (AC0080I550090A / AC0080I700090A / AC0080I850090A / AC0080I100090A) e su cassetta di profondità 110 (AC0080I500000A / AC0080I700000A / AC0080I100000A)

***staffa standard/staffa opzionale

* *standard bracket already assembled (H= 89 for manifolds of 1" ; H=99 for manifolds of 1"1/4) for use with 110 depth case (AC0080I500000A / AC0080I700000A / AC0080I100000A)*

** *Optional bracket, not present in the package (H= 76 for manifolds of 1" ; H=86 for manifolds of 1"1/4), for use with 90 depth case (AC0080I550090A / AC0080I700090A / AC0080I850090A / AC0080I100090A) and 110 depth case (AC0080I500000A / AC0080I700000A / AC0080I100000A)*

****standard/optional bracket*

COMPONENTI 6500.H6 COMPONENTS: 6500.H6

Collettore di distribuzione composto da:

- Collettore di mandata completo di flussimetri e nipples
- Collettore di ritorno completo di valvole di intercettazione predisposte per comando elettrotermico
- Derivazioni 3/4" Eurocono
- Valvole di sfogo e rubinetti carico/scarico
- Staffe di fissaggio

Manifold composed of:

- *Delivery manifold with flow meters and nipples*
- *Return manifold complete with pre-arranged shut-off valves for electrothermal command*
- *3/4" Eurocone adapters*
- *Air vent valves and charge/discharge valves*
- *Brackets*

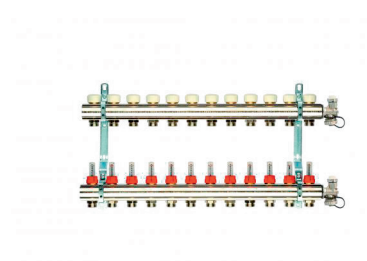

CONNESSIONI 6500.H6 CONNECTIONS: 6500.H6

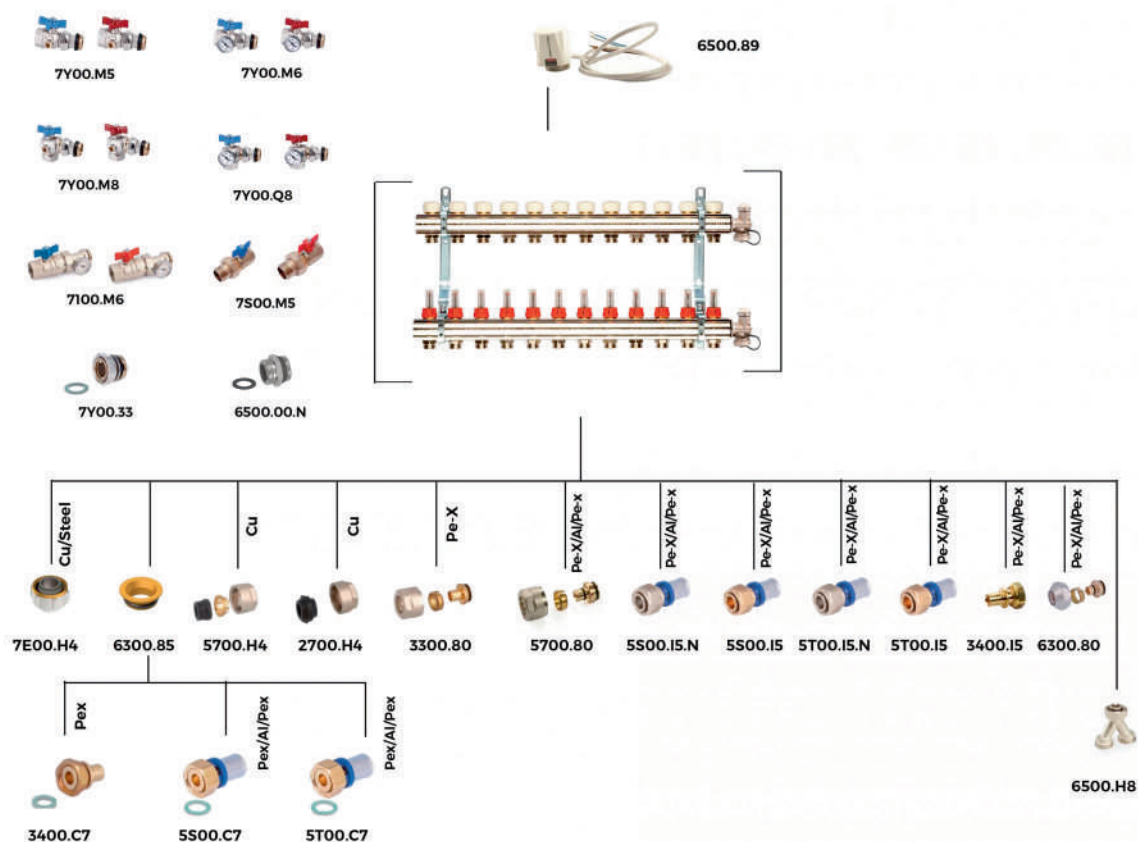

INSERTI E RACCORDI INSERTS AND FITTINGS

CODICE CODE	DESCRIZIONE DESCRIPTION	TUBO PIPE
7Y00.M5	Valvola a sfera compatta bocchettone con farfalla senza termometro Compact ball valve coupling with butterfly, without thermometer	
7Y00.M6	Valvola a sfera compatta bocchettone con farfalla con termometro Compact 90-degree ball valve coupling with butterfly and thermometer	
7Y00.M8	Valvola a sfera compatta a squadra bocchettone con farfalla senza termometro Compact 90-degree ball valve coupling with butterfly, no thermometer	
7Y00.Q8	Valvola a sfera compatta a squadra bocchettone con farfalla con termometro Compact 90-degree ball valve coupling with butterfly, no thermometer	
7100.M6	Valvola a sfera con termometro Ball valve with thermometer	
7500.M5	Valvola a sfera con bocchettone Manifold ball valve	
6300.80	Dado nichelato, ogiva e inserto eurocono Nickel plated nut, olive and insert eurocone	Tubo multistrato Multilayer pipe

INSERTI E RACCORDI INSERTS AND FITTINGS		
6300.85	Adattatore sede piana eurocono Eurocone flat seal adapter	Tubo rame Copper pipe
7E00.H4	Kit eurocono nichelato Nickel plated eurokonus kit	Tubo Pe-X Pe-X pipe
5700.H4	Dado nichelato con ogiva e guarnizione inclusa Nickel plated nut with assembled ring and gasket	Tubo multistrato Multilayer pipe
2700.H4	Dado nichelato con ogiva e guarnizione inclusa Nickel plated nut with assembled ring and gasket	Tubo multistrato Multilayer pipe
3300.80	Dado nichelato, ogiva e inserto eurocono Nickel plated nut, olive and insert eurocone	Tubo multistrato Multilayer pipe
5700.80	Dado nichelato, ogiva e inserto eurocono Nickel plated nut, olive and insert eurocone	
5500.I5	Raccordo dritto sede conica O-Ring con girello- Straight fitting with loose nut and conical connection	Tubo multistrato Multilayer pipe
5500.I5.N	Raccordo dritto nichelato sede conica O-Ring con girello- Nickel-plated straight fitting with loose nut and conical connection	Tubo multistrato Multilayer pipe
5T00.I5	Raccordo dritto sede conica O-Ring con girello- Straight fitting with loose nut and conical connection	Tubo multistrato Multilayer pipe
5T00.I5.N	Raccordo dritto nichelato sede conica O-Ring con girello- Nickel-plated straight fitting with loose nut and conical connection	Tubo multistrato Multilayer pipe
3400.I5	Raccordo diritto eurocono con girello Straight fitting with loose nut and eurocone connection	tubo Pe-X Pe-X pipe
6500.H8	Raccordo sdoppiatore nichelato Eurocone nickel plated splitter	
3400.C7	Raccordo diritto sede piana con girello Straight fitting with loose nut and flat washer	Tubo Pe-X Pe-X pipe
5500.C7	Raccordo diritto sede piana con girello Straight fitting with loose nut and flat washer	Tubo multistrato Multilayer pipe
5T00.C7	Raccordo diritto sede piana con girello Straight fitting with loose nut and flat washer	Tubo multistrato Multilayer pipe
7Y00.33	Raccordo collettore nichelato Nickel-plated manifold fitting	
6500.00.N	Raccordo m/m con o-ring e guarnizione piatta Male fitting with o-ring and flat gasket	

DIMENSIONI 6500.H6
DIMENSIONS: 6500.H6

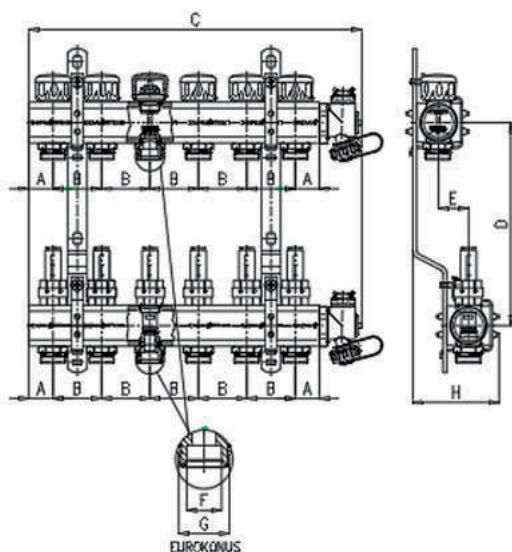

CODICE CODE	A	B	C	D	E***	F	G	H*	H**	I	VIE	Ø TUBO
6500H6N100502A	25	50	100	200	3/18	18.1	3/4"	89	76	319	2	1"-3/4" Ek.
6500H6N100503A	25	50	150	200	3/18	18.1	3/4"	89	76	319	3	1"-3/4" Ek.
6500H6N100504A	25	50	200	200	3/18	18.1	3/4"	89	76	319	4	1"-3/4" Ek.
6500H6N100505A	25	50	250	200	3/18	18.1	3/4"	89	76	319	5	1"-3/4" Ek.
6500H6N100506A	25	50	300	200	3/18	18.1	3/4"	89	76	319	6	1"-3/4" Ek.
6500H6N100507A	25	50	350	200	3/18	18.1	3/4"	89	76	319	7	1"-3/4" Ek.
6500H6N100508A	25	50	400	200	3/18	18.1	3/4"	89	76	319	8	1"-3/4" Ek.
6500H6N100509A	25	50	450	200	3/18	18.1	3/4"	89	76	319	9	1"-3/4" Ek.
6500H6N100510A	25	50	500	200	3/18	18.1	3/4"	89	76	319	10	1"-3/4" Ek.
6500H6N100511A	25	50	550	200	3/18	18.1	3/4"	89	76	319	11	1"-3/4" Ek.
6500H6N100512A	25	50	600	200	3/18	18.1	3/4"	89	76	319	12	1"-3/4" Ek.
6500H6N120502A	30	50	110	200	3/18	18.1	3/4"	99	86	319	2	1 1/4-3/4" Ek.
6500H6N120503A	30	50	160	200	3/18	18.1	3/4"	99	86	319	3	1 1/4-3/4" Ek.
6500H6N120504A	30	50	240	200	3/18	18.1	3/4"	99	86	319	4	1 1/4-3/4" Ek.
6500H6N120505A	30	50	260	200	3/18	18.1	3/4"	99	86	319	5	1 1/4-3/4" Ek.
6500H6N120506A	30	50	310	200	3/18	18.1	3/4"	99	86	319	6	1 1/4-3/4" Ek.
6500H6N120507A	30	50	360	200	3/18	18.1	3/4"	99	86	319	7	1 1/4-3/4" Ek.
6500H6N120508A	30	50	410	200	3/18	18.1	3/4"	99	86	319	8	1 1/4-3/4" Ek.
6500H6N120509A	30	50	460	200	3/18	18.1	3/4"	99	86	319	9	1 1/4-3/4" Ek.
6500H6N120510A	30	50	510	200	3/18	18.1	3/4"	99	86	319	10	1 1/4-3/4" Ek.
6500H6N120511A	30	50	560	200	3/18	18.1	3/4"	99	86	319	11	1 1/4-3/4" Ek.
6500H6N120512A	30	50	610	200	3/18	18.1	3/4"	99	86	319	12	1 1/4-3/4" Ek.

* staffa standard già montata (H= 89 per collettori da 1" ; H=99 per collettori da 1"1/4) per utilizzo su cassetta di profondità 110 (AC0080I500000A / AC0080I700000A / AC0080I100000A)

** staffa opzionale, non presente nella confezione(H= 76 per collettori da 1" ; H=86 per collettori da 1"1/4), per utilizzo su cassetta di profondità 90 (AC0080I550090A / AC0080I700090A / AC0080I850090A /AC0080I100090A) e su cassetta di profondità 110 (AC0080I500000A / AC0080I700000A / AC0080I100000A)

***staffa standard/staffa opzionale

** standard bracket already assembled (H= 89 for manifolds of 1" ; H=99 for manifolds of 1"1/4) for use with 110 depth case (AC0080I500000A / AC0080I700000A / AC0080I100000A)*

*** Optional bracket, not present in the package (H= 76 for manifolds of 1" ; H=86 for manifolds of 1"1/4), for use with 90 depth case (AC0080I550090A / AC0080I700090A / AC0080I850090A /AC0080I100090A) and 110 depth case (AC0080I500000A / AC0080I700000A / AC0080I100000A)*

****standard/optional bracket*

6500.71

COLLETORE DI DISTRIBUZIONE CON MISURATORI
DI PORTATA
DISTRIBUTION MANIFOLD WITH BALANCING FLOW
METERS

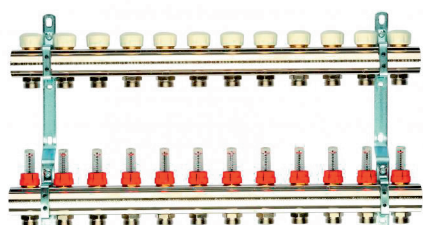

CODICE			
650071N100502A	2	1"	200
650071N100503A	3	1"	200
650071N100504A	4	1"	200
650071N100505A	5	1"	200
650071N100506A	6	1"	200
650071N100507A	7	1"	200
650071N100508A	8	1"	200
650071N100509A	9	1"	200
650071N100510A	10	1"	200
650071N100511A	11	1"	200
650071N100512A	12	1"	200
650071N120502A	2	1"1/4	200
650071N120503A	3	1"1/4	200
650071N120504A	4	1"1/4	200
650071N120505A	5	1"1/4	200
650071N120506A	6	1"1/4	200
650071N120507A	7	1"1/4	200
650071N120508A	8	1"1/4	200
650071N120509A	9	1"1/4	200
650071N120510A	10	1"1/4	200
650071N120511A	11	1"1/4	200
650071N120512A	12	1"1/4	200

6500.72

COLLETORE DI DISTRIBUZIONE CON MISURATORI
DI PORTATA E VALVOLE
DISTRIBUTION MANIFOLD WITH BALANCING FLOW
METERS AND VALVES

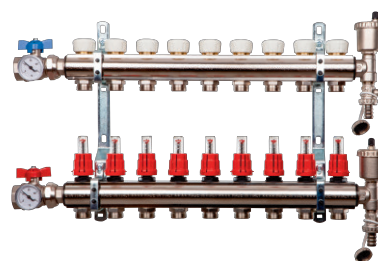



CODICE			
650072N100502A	2	1"	200
650072N100503A	3	1"	200
650072N100504A	4	1"	200
650072N100505A	5	1"	200
650072N100506A	6	1"	200
650072N100507A	7	1"	200
650072N100508A	8	1"	200
650072N100509A	9	1"	200
650072N100510A	10	1"	200
650072N100511A	11	1"	200
650072N100512A	12	1"	200
650072N120502A	2	1"1/4	200
650072N120503A	3	1"1/4	200
650072N120504A	4	1"1/4	200
650072N120505A	5	1"1/4	200
650072N120506A	6	1"1/4	200
650072N120507A	7	1"1/4	200
650072N120508A	8	1"1/4	200
650072N120509A	9	1"1/4	200
650072N120510A	10	1"1/4	200
650072N120511A	11	1"1/4	200
650072N120512A	12	1"1/4	200

6500.93

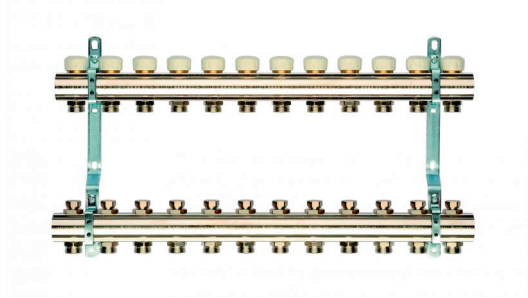
COLLETTORE DI DISTRIBUZIONE CON VITONE A
MEMORIA MECCANICA
DISTRIBUTION MANIFOLD WITH MECHANICAL
BALANCING SCREW



CODICE			
650093N100502A	2	1"	200
650093N100503A	3	1"	200
650093N100504A	4	1"	200
650093N100505A	5	1"	200
650093N100506A	6	1"	200
650093N100507A	7	1"	200
650093N100508A	8	1"	200
650093N100509A	9	1"	200
650093N100510A	10	1"	200
650093N100511A	11	1"	200
650093N100512A	12	1"	200
650093N120502A	2	1" 1/4	200
650093N120503A	3	1" 1/4	200
650093N120504A	4	1" 1/4	200
650093N120505A	5	1" 1/4	200
650093N120506A	6	1" 1/4	200
650093N120507A	7	1" 1/4	200
650093N120508A	8	1" 1/4	200
650093N120509A	9	1" 1/4	200
650093N120510A	10	1" 1/4	200
650093N120511A	11	1" 1/4	200
650093N120512A	12	1" 1/4	200

6500.H6

COLLETTORE DI DISTRIBUZIONE CON MISURATORI
DI PORTATA E TERMINALE
DISTRIBUTION MANIFOLD WITH FLOW METERS AND
TERMINAL

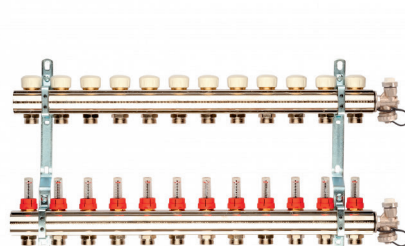

CODICE			
6500H6N100502A	1"	2	3/4"
6500H6N100503A	1"	3	3/4"
6500H6N100504A	1"	4	3/4"
6500H6N100505A	1"	5	3/4"
6500H6N100506A	1"	6	3/4"
6500H6N100507A	1"	7	3/4"
6500H6N100508A	1"	8	3/4"
6500H6N100509A	1"	9	3/4"
6500H6N100510A	1"	10	3/4"
6500H6N100511A	1"	11	3/4"
6500H6N100512A	1"	12	3/4"
6500H6N100513A	1"	13	3/4"
6500H6N120502A	1" 1/4	2	3/4"
6500H6N120503A	1" 1/4	3	3/4"
6500H6N120504A	1" 1/4	4	3/4"
6500H6N120505A	1" 1/4	5	3/4"
6500H6N120506A	1" 1/4	6	3/4"
6500H6N120507A	1" 1/4	7	3/4"
6500H6N120508A	1" 1/4	8	3/4"
6500H6N120509A	1" 1/4	9	3/4"
6500H6N120510A	1" 1/4	10	3/4"
6500H6N120511A	1" 1/4	11	3/4"
6500H6N120512A	1" 1/4	12	3/4"

6500.89

COMANDI ELETTROTHERMICI
ELECTROTHERMIC CONTROL



CODICE	i	
650089H2300W4A	230V 4 fili	50

Comando elettrotermico (nc) con 4 fili e 230v; grado di protezione IP54; temperatura ambiente di funzionamento 0-50°C; tempo d'intervento 3 min.

Electrothermic control (nc) with 4 wires and 230 V; grade of protection IP54; ambient working temperature 0-50°C; intervention time 3 min.



LOKI

SERIE 6M00 LINE 6M00



Collettori di distribuzione modulari in ottone Brass modular distribution manifolds

I collettori della SERIE 6M00 denominati Loki con uscite da $\frac{3}{4}$ " Eurocono sono la soluzione ideale per la distribuzione di acqua in impianti di riscaldamento e raffrescamento radiante. L'estrema flessibilità data dalla possibilità di poterli assemblare a piacimento, permette molteplici combinazioni e la riduzione dello stock a magazzino.

La filettatura fasata e la tenuta O-Ring consentono un rapido montaggio e allineamento delle derivazioni senza l'ausilio di nessuna attrezzatura e la garanzia di tenuta senza l'impiego di canapa o teflon.

Numerosi accessori permettono di completare il collettore con tutti i componenti necessari al funzionamento dell'impianto: staffe, valvole a sfera di intercettazione, valvole di sfiato e rubinetti di carico-scarico.

The 6M00 SERIES manifolds called Loki with $\frac{3}{4}$ " Eurocone outlets are the ideal solution for the distribution of water in radiant heating and cooling systems. The extreme flexibility offered by the ability to assemble them at will offers multiple combinations and helps reduce warehouse stock.

The self-seal thread and O-Ring seal allow quick assembly and alignment of the connectors without the aid of any equipment and a guaranteed seal without the use of plumber's hemp or Teflon.

A wide range of accessories makes it possible to assemble the manifold with all the necessary components for the proper functioning of the system: brackets, shut-off ball valves, venting valves and input-output taps.







VANTAGGI

- Riduzione dello stock di magazzino
- Massima flessibilità e semplicità di configurazione. Grazie alla fasatura dei filetti la composizione è allineata
- No ad inutili sprechi
- Utilizzabili in impianti sia a bassa che ad alta temperatura
- Interasse costante 50mm
- Garanzia di tenuta senza sigillanti grazie all'O-ring: rapidità d'installazione
- Materie prime impiegate di alta qualità (UBA LIST)
- Adatti a tutte le tipologie di tubo plastico, metallo e metallo-plastico
- Rintracciabilità garantita dal datario impresso sul corpo del collettore
- Bilanciamento di ogni derivazione

ADVANTAGES

- Stock reduction
- Maximum flexibility and easy configuration. Self aligning granting the correct and quick aligning of the coupled manifolds
- No unnecessary waste
- Suitable both for high and low temperature installations
- CONSTANT CENTER DISTANCE 50mm
- PERFECTLY TIGHT: thanks to the O-Ring the coupling is tight without using any additional means, such as Teflon tape or hemp, for a faster installation
- High-quality raw materials (UBA LIST)
- Suitable for plastic, metal and metal-plastic pipes
- Product traceability guaranteed by the date stamped on the body of the manifold
- Balancing of each loop

APPLICAZIONI E PRESTAZIONI FIELDS OF APPLICATION

APPLICAZIONI APPLICATIONS	T. min. con vitone T. min with mechanical screw	T. min. con flussimetro T. min with flow meter	T. max con vitone T. max with mechanical screw	T. max con flussimetro T. max with flow meter	Press. max con vitone Press. max with mechanical screw	Press. max con flussimetro Press. max with flow meter	Portata con flussimetro Flow rate with flow meter
 riscaldamento a pavimento low temperature heating (floor)	-20°C	-7°C	+95°C	+65°C	10 bar	6 bar	0.5 lt/min
 riscaldamento a parete low temperature heating (wall)	-20°C	-7°C	+95°C	+65°C	10 bar	6 bar	0.5 lt/min
 riscaldamento a soffitto low temperature heating (ceiling)	-20°C	-7°C	+95°C	+65°C	10 bar	6 bar	0.5 lt/min
 radiatori radiators	-20°C	-7°C	+95°C	+65°C	10 bar	6 bar	0.5 lt/min
 raffrescamento cooling	-20°C	-7°C	+95°C	+65°C	10 bar	6 bar	0.5 lt/min
 -20°C: solo con liquido antigelo, glicole, in % max del 30% -20°C: only with antifreeze liquid (glycol) in % max of 30%							

COMPONENTI E MATERIALI 6M00.88 COMPONENTS AND MATERIALS 6M00.88

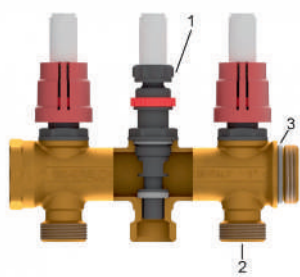

LEGENDA LEGEND	COMPONENTI COMPONENTS	MATERIALI MATERIALS
1	Flussimetro Flowmeter	Plastica Plastic
2	Collettore Manifold	CW617N - UNI EN 12165
3	O-Ring	Elastomero Elastomer

COMPONENTI E MATERIALI 6M00.90 COMPONENTS AND MATERIALS 6M00.90

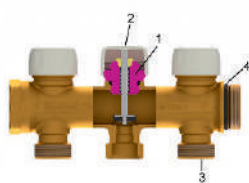

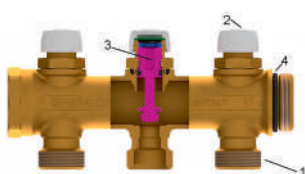

LEGENDA LEGEND	COMPONENTI COMPONENTS	MATERIALI MATERIALS
1	Vitone Mechanical balancing screw	CW617N - UNI EN 12164 Brass CW617N - UNI EN 12164
2	Manopola Knob	ABS
3	Collettore Manifold	CW617N - UNI EN 12165 Brass CW617N - UNI EN 12165
4	O-Ring	Elastomero Elastomer

COMPONENTI E MATERIALI 6M00.99 COMPONENTS AND MATERIALS 6M00.99



LEGENDA LEGEND	COMPONENTI COMPONENTS	MATERIALI MATERIALS
1	Collettore Manifold	CW617N - UNI EN 12165
2	Manopola Knob	ABS
3	Vitone Headwork	CW617N - UNI EN 12164
4	O-Ring	Elastomero Elastomer

CERTIFICAZIONI CERTIFICATIONS

STATO COUNTRY	CERTIFICAZIONE CERTIFICATION	STATO COUNTRY	CERTIFICAZIONE CERTIFICATION	STATO COUNTRY	CERTIFICAZIONE CERTIFICATION
					

NORMATIVE

- UNI EN ISO 228-1
Filettatura di tubazioni per accoppiamento non a tenuta sul filetto

REGULATIONS

- *UNI EN ISO 228-1:2003*
Threads complies with UNI EN ISO 228-1:2003 law: "Piping thread for coupling not with tightness on the thread"

FLUSSIMETRI

Funzione "memory-stop" flussimetro.
Sistema di bloccaggio del grado di apertura del flussimetro che consente, alla riapertura del circuito, l'arresto della corsa nella impostazione iniziale (valore di progetto).

FLOWMETER "MEMORY - STOP" FUNCTION

Funzione "memory-stop" flussimetro.
Blocking system of the opening grade of the flowmeter which allows, once the system is reopened, the stopping of the run at its initial setting (project value).

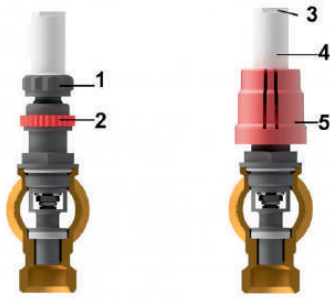

LEGENDA LEGEND	COMPONENTI COMPONENTS
1	Ghiera regolazione Regulation ring
2	Ghiera memory stop Memory stop ring
3	Esagono bicchiere Glass hexagon part
4	Bicchiere Glass
5	Volantino Control

1) Impostare la regolazione del flussimetro a valore di progetto. Il volantino, durante questa operazione, deve essere tolto;
 2) Avvitare la ghiera di "Memory-Stop" in senso antiorario (filettatura sinistra) fino ad arrivare a fine corsa;
 3) Riposizionare il volantino. Agendo sul volantino (ruotando in senso orario) è possibile chiudere il singolo circuito. Ruotando in senso contrario fino al suo bloccaggio, è possibile riaprire il circuito, fino a valore di progetto impostato.
 Tramite le due asole presenti sul volantino è possibile piombare il Flussimetro, onde evitarne la manomissione della regolazione impostata.
 Attenzione: NON utilizzare attrezzi per la manovra/regolazione del flussimetro, onde pregiudicarne il corretto funzionamento del flussimetro stesso.

1) Set the Flowmeter control to the design value. The control wheel must be removed during this operation.
 2) Turn the "Memory stop" ferrule anticlockwise (left-hand thread) to the end of its travel.
 3) Put the control wheel back on. The individual circuit can be closed by turning the wheel clockwise. By turning it the other way up to the stop it is possible to reopen the circuit to the set design value.
 Using the two holes in the control wheel it is possible to seal the Flowmeter so as to prevent tampering with the setting.
 Warning: do NOT use any tools to turn/manipulate the Flowmeter, as to do so could stop it working properly.

FLUSSIMETRO 0.5 L FLOWMETER 0.5 L

DP Pa	DP kpa	Q l/h
10	0.01	8
100	0.1	25
500	0.5	60
1000	1	82
5000	5	185
10000	10	260
20000	20	365
30000	30	450
40000	40	520
50000	50	585
60000	60	640
70000	70	690
80000	80	740
90000	90	785
100000	100	825

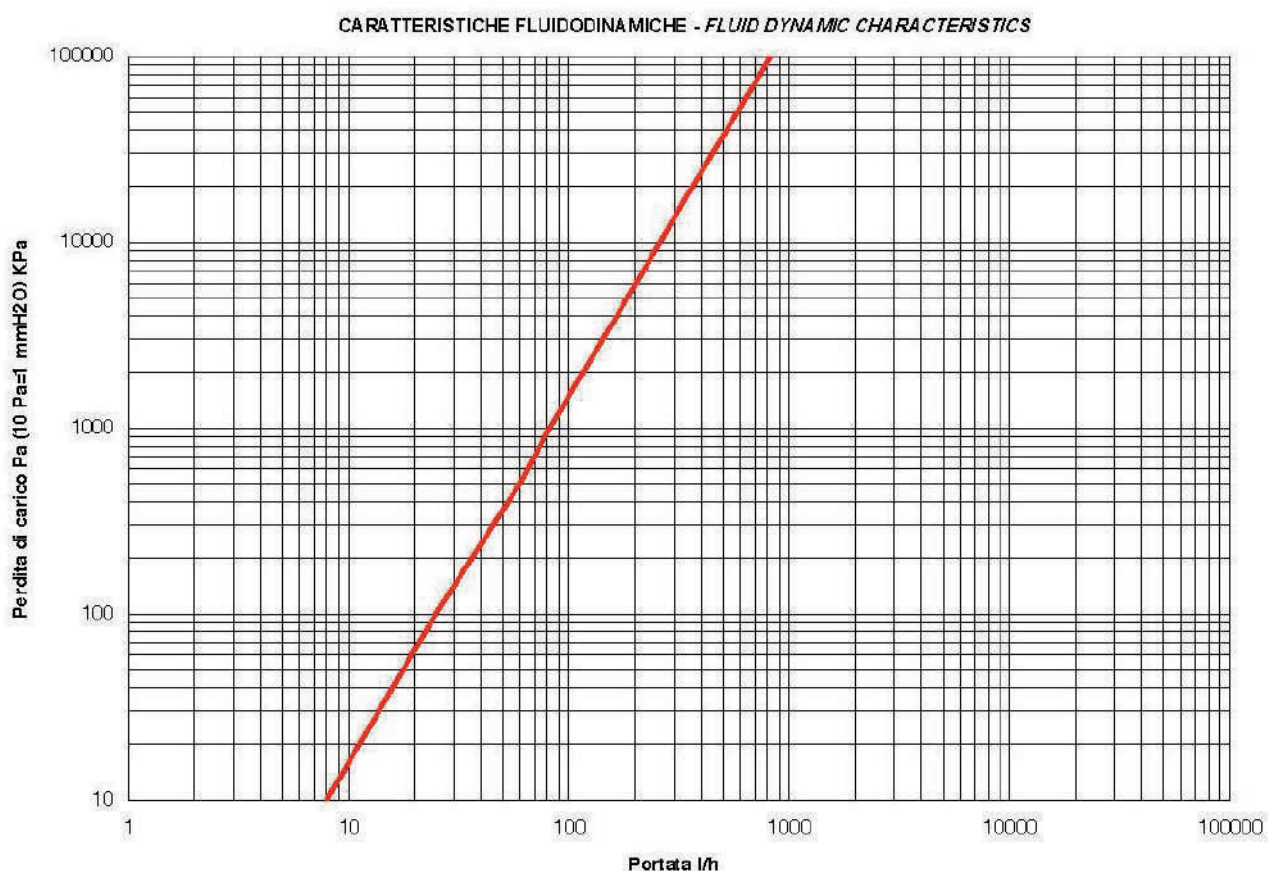

ISTRUZIONI DI MANUTENZIONE

Il bicchiere può essere smontato ed ispezionato per una eventuale pulizia anche con impianto funzionante.

- 1) Chiudere il flussimetro ruotando l'anello, non prima di aver registrato il bilanciamento (l/min) dell'impianto
- 2) Con l'ausilio di una chiave esagonale svitare il bicchiere agendo sulla struttura esagonale dello stesso
- 3) Procedere alla pulizia del bicchiere
- 4) Riavvitare il bicchiere nella posizione originale, bilanciando nuovamente l'impianto.

MAINTENANCE INSTRUCTIONS

The glass can be disassembled in order to check its cleanliness, even when the installation is working.

- 1) *Close the flow meter turning the ring, but not before than having recorded the installation balancing (l/min)*
- 2) *With the help of a hexagonal wrench, unscrew the glass by acting on the hexagonal structure of the glass*
- 3) *Clean the glass*
- 4) *Re-insert the glass in its original position, balancing again the installation*

BILANCIAMENTO MECCANICO DELL'IMPIANTO

I misuratori di portata (o flussimetri) e i detentori a memoria meccanica (detentori) sono situati sulla mandata del circuito, in questo modo è possibile stabilire il valore della portata teorica dell'impianto idraulico, tramite la regolazione dei misuratori/regolatori, che sarà

MECHANICAL BALANCING OF THE INSTALLATION

Flow measuring devices (flow meters) are located on the delivery circuit, making it possible to establish the theoretical flow value of the hydraulic system through the adjustment of the meters/regulators, which will be carried out by the installation technician.

effettuata del tecnico installatore.
Tale regolazione si deve compiere con la valvola in posizione di ritorno totalmente aperta.
Accertato che le portate di ogni circuito idraulico determinano una perdita di carico dell'impianto, è fondamentale che le regolazioni siano eseguite manualmente per tutti gli anelli dei misuratori, fino a raggiungere i valori di portata in l/ min determinati dal progetto.

*You have to adjust it when the valve is in the back-draft position and completely open.
Given that the flow of each plumbing circuit causes a loose in installation capacity, for each ring of the flow meter is basic that the adjustment are made by hand until you reach flow value in litre/minutes decided by the plan.*

DETENTORI (vitoni a memoria meccanica)

Istruzioni di regolazione dei collettori con detentori:

- Svitare il tappo
- Con la chiave a brugola avvitare l'otturatore fino a raggiungere la posizione di chiusura
- Il detentore è pronto per essere regolato come da tabella sottostante
- Utilizzare la ghiera per creare un fine corsa meccanico, avvitandola a battuta sull'otturatore una volta impostata la portata desiderata. In questo modo è possibile aprire e chiudere l'otturatore senza perdere la regolazione impostata.

LOCKSHIELDS (mechanical memory stem)

Calibration instructions for manifolds with lockshields:

- *Unscrew the cap*
- *Using a hex key, tighten the cut-off valve until it's completely closed*
- *The lockshield is ready to be adjusted as per the chart below*
- *Use the closing ring to create a mechanical stop, tightening it down to the cut-off valve once the desired flow has been set. By so doing, the cut-off valve can be opened and closed without altering the set calibration.*

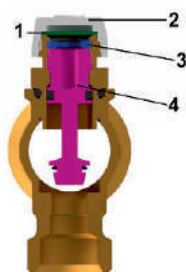

LEGENDA LEGEND	COMPONENTI COMPONENTS
1	Guarnizione Gasket
2	Tappo Cap
3	Ghiera Closing ring
4	Otturatore Cut off valve

Posizione Position	N° giri N° turns	Kvs (m ³ /h)
1	1/2	0.09
2	1	0.27
3	1+1/2	0.73
4	2	0.91
5	2+1/2	1.08
6	3	1.26
7	3+1/2	1.41
8	4	1.53
9	4+1/2	1.65
10	5	1.76
11	5+1/2	1.85
12	tutto aperto completely open	1.92

PROTEZIONE DEL BILANCIAMENTO IDRAULICO CONTRO LE MANOMISSIONI

La regolazione dei regolatori e dei misuratori di portata può essere bloccata con un coperchio di arresto, eventualmente piombato.

PROTECTING HYDRAULIC BALANCING FROM TAMPERING

Adjustment of the flow regulators and meters can be blocked by a protective cover, sealed if necessary.

Valvole di intercettazione predisposte per comando elettrotermico Pre-set shut-off valves for electrothermal command

1. Svitare la manopola di protezione
2. Posizionare la testa termoelettrica sulla valvola
3. Avvitare a mano la ghiera metallica (filettatura M30x1.5)
4. Eseguire i collegamenti elettrici

1. *Unscrew the protection handle*
2. *Place the electrothermal head on the valve*
3. *Tighten the metal closing ring by hand (threading: M30x1.5)*
4. *Complete the electrical connections*

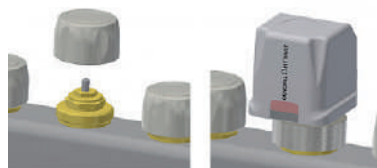

CONNESSIONI CONNECTIONS:

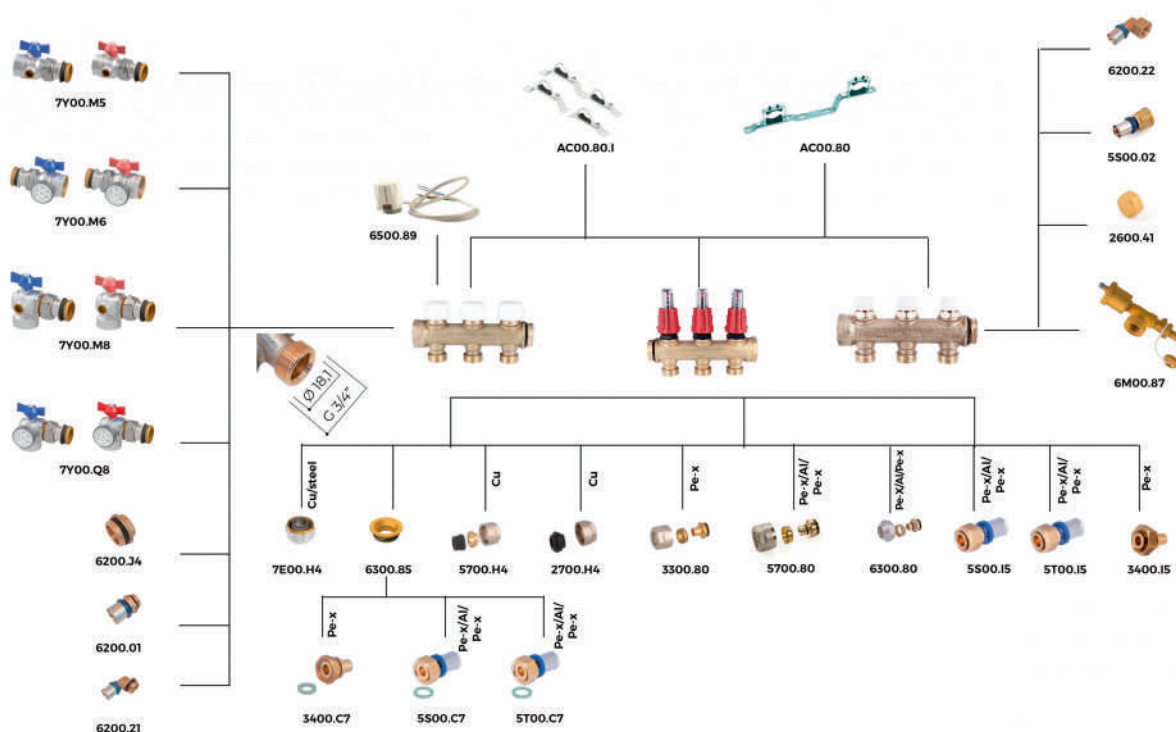

INSERTI E RACCORDI INSERTS AND FITTINGS

CODICE CODE	DESCRIZIONE DESCRIPTION	TUBO PIPE
7Y00.M5	Valvola a sfera compatta bocchettone con farfalla senza termometro Compact ball valve coupling with butterfly, without thermometer	
7Y00.M6	Valvola a sfera compatta bocchettone con farfalla con termometro Compact ball valve coupling with butterfly and thermometer	
7Y00.M8	Valvola a sfera compatta a squadra bocchettone con farfalla senza termometro Compact angle ball valve coupling with butterfly, without thermometer	
7Y00.Q8	Valvola a sfera compatta a squadra bocchettone con farfalla con termometro Compact 90 degree ball valve coupling with butterfly and thermometer	
6200.J4	Tappo maschio con o-ring Male cap with O-ring	
6200.01	Raccordo diritto maschio con o-ring Straight male fitting with O-ring	
6200.21	Angolo maschio fasato con o-ring Self-sealed male elbow with O-ring	
6200.22	Angolo femmina fasato con o-ring Self-sealed female elbow with O-ring	

INSERTI E RACCORDI INSERTS AND FITTINGS		
5500.02	Raccordo diritto femmina Female straight fitting	
2600.41	Tappo femmina Female cap	
6M00.87	Terminale per collettori modulari loki Terminal for Loki modular manifolds	
6500.89	Comandi elettrotermici Electrothermic control	
AC00.80	Staffe per collettori Brackets for manifolds	
AC00.80.I	Staffe per collettori Brackets for manifolds	
6300.85	Adattatore sede piana eurocono Eurocone flat seal adapter	
7E00.H4	Adattatore Adapter	Tubo rame/acciaio Copper/Steel pipe
3400.C7	Raccordo diritto sede piana con girello Straight fitting with loose nut and flat washer	Tubo Pe-X Pe-X pipe
5500.C7	Raccordo diritto sede piana con girello Straight fitting with loose nut and flat washer	Tubo multistrato Multilayer pipe
5T00.C7	Raccordo diritto sede piana con girello Straight fitting with loose nut and flat washer	Tubo multistrato Multilayer pipe
5700.H4	Dado nichelato con ogiva e guarnizione inclusa Nickel plated nut with assembled ring and gasket	Tubo rame Copper pipe
2700.H4	Dado nichelato con ogiva e guarnizione inclusa Nickel plated nut with assembled ring and gasket	Tubo rame Copper pipe
3300.80	Dado nichelato, ogiva e inserto eurocono Nickel plated nut, olive and insert eurocone	Tubo Pe-X Pe-X pipe
5700.80	Dado nichelato, ogiva e inserto eurocono Nickel plated nut, olive and insert eurocone	Tubo multistrato Multilayer pipe
6300.80	Dado nichelato, ogiva e inserto eurocono Nickel plated nut, olive and insert eurocone	Tubo multistrato Multilayer pipe
5500.I5	Raccordo dritto sede conica O-Ring con girello- Straight fitting with loose nut and conical connection	Tubo multistrato Multilayer pipe
5T00.I5	Raccordo dritto sede conica O-Ring con girello- Straight fitting with loose nut and conical connection	Tubo multistrato Multilayer pipe
3400.I5	Raccordo dritto eurocono con girello Straight fitting with loose nut and eurocone connection	Tubo Pe-X Pe-X pipe

DIMENSIONI 6M00.88
DIMENSIONS 6M00.88

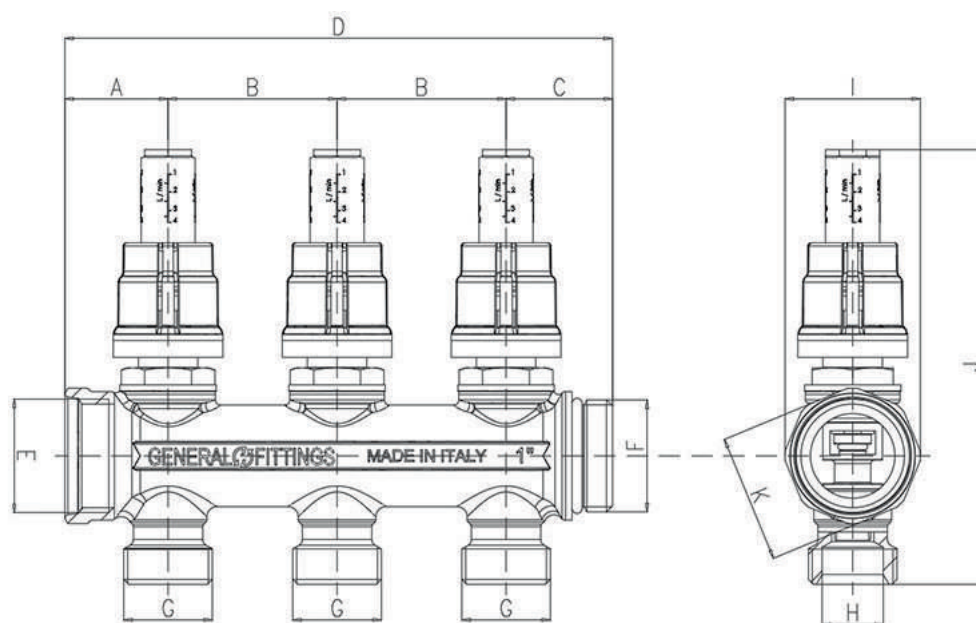

CODICE CODE	A	B	C	D	E	F	G	H	I	J	K
6M0088H100502A	30.5	50	31.5	112	G 1"	G 1"	G 3/4"	Ø 18,1	40	128.5	38
6M0088H100503A	30.5	50	31.5	162	G 1"	G 1"	G 3/4"	Ø 18,1	40	128.5	38
6M0088H100504A	30.5	50	31.5	212	G 1"	G 1"	G 3/4"	Ø 18,1	40	128.5	38

DIMENSIONI 6M00.90
DIMENSIONS 6M00.90

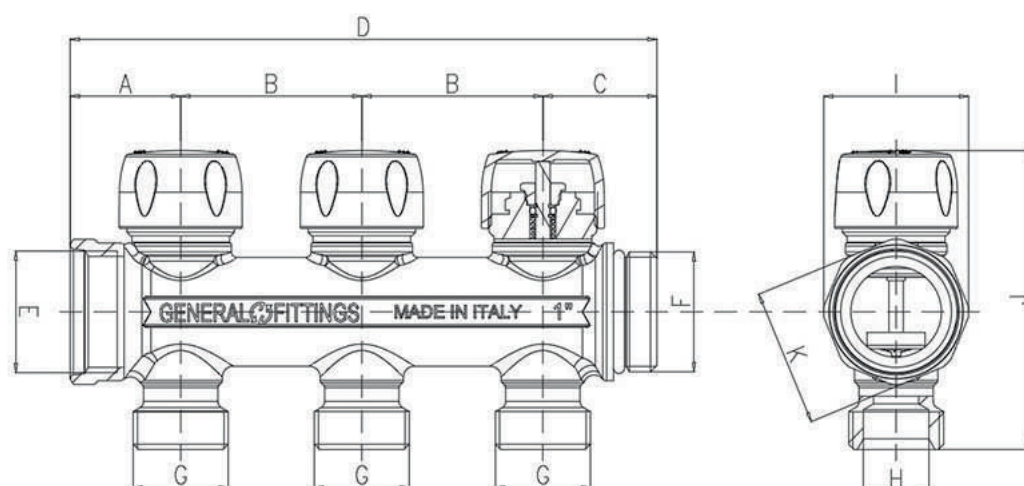

CODICE CODE	A	B	C	D	E	F	G	H	I	J	K
6M0090H100502A	30.5	50	31.5	112	G 1"	G 1"	G 3/4"	Ø 18,1	40	82.5	38
6M0090H100503A	30.5	50	31.5	162	G 1"	G 1"	G 3/4"	Ø 18,1	40	82.5	38
6M0090H100504A	30.5	50	31.5	212	G 1"	G 1"	G 3/4"	Ø 18,1	40	82.5	38

DIMENSIONI 6M00.99
DIMENSIONS 6M00.99

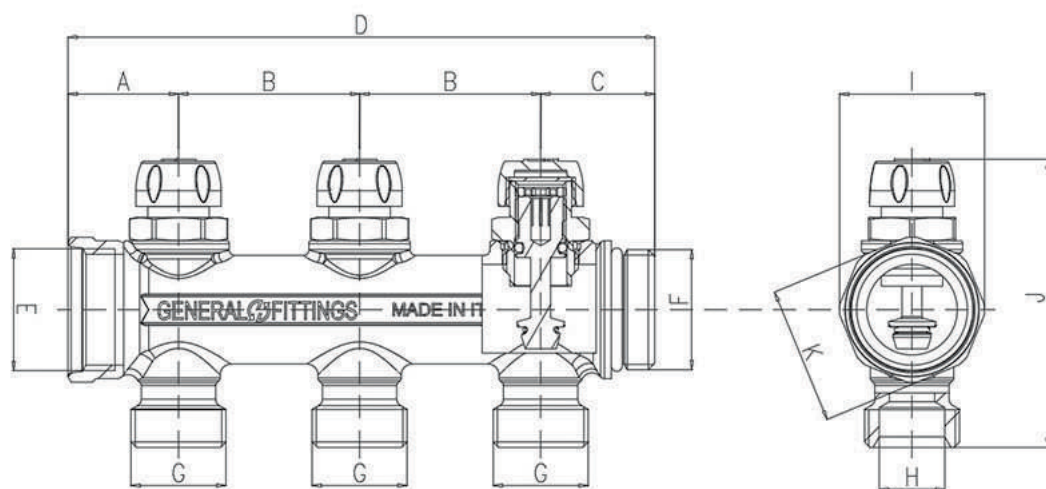

CODICE CODE	A	B	C	D	E	F	G	H	I	J	K
6M0099H100502A	30.5	50	31.5	112	G 1"	G 1"	G 3/4"	Ø 18,1	40	79.5	38
6M0099H100503A	30.5	50	31.5	162	G 1"	G 1"	G 3/4"	Ø 18,1	40	79.5	38
6M0099H100504A	30.5	50	31.5	212	G 1"	G 1"	G 3/4"	Ø 18,1	40	79.5	38

6M00.88 COLLETTORE MODULARE M/F CON FLUSSIMETRI
MODULAR M/F MANIFOLD WITH FLOW METERS



CODICE				
6M0088H100502A	2	1"	3/4" EK	16
6M0088H100503A	3	1"	3/4" EK	10
6M0088H100504A	4	1"	3/4" EK	8

6M00.99 COLLETTORE MODULARE M/F CON DETENTORE
MODULAR M/F MANIFOLD WITH LOCKSHIELD



CODICE				
6M0099H100502A	2	1"	3/4" EK	16
6M0099H100503A	3	1"	3/4" EK	10
6M0099H100504A	4	1"	3/4" EK	8

6M00.90 COLLETTORE MODULARE M/F CON VALVOLE
MODULAR M/F MANIFOLD WITH VALVES



CODICE				
6M0090H100502A	2	1"	3/4" EK	16
6M0090H100503A	3	1"	3/4" EK	10
6M0090H100504A	4	1"	3/4" EK	8

6200.01 RACCORDO DIRITTO MASCHIO CON O-RING
MALE STRAIGHT FITTING WITH O-RING



CODICE				
620001H102630A	3.0	1"x26	5	40
620001H103230A	3.0	1"x32	5	40

6200.21 ANGOLO MASCHIO FASATO CON O-RING
SELF-SEAL MALE ELBOW WITH O-RING



CODICE				
620021H102630A	3.0	1"x26	5	25

6200.21 ANGOLO MASCHIO FASATO CON O-RING
SELF-SEAL MALE ELBOW WITH O-RING



CODICE	+	Ø	◇	☐
620021H103230A	3.0	1"x32	5	20

6200.22 ANGOLO FEMMINA FASATO
SELF-SEAL FEMALE ELBOW WITH O-RING



CODICE	+	Ø	◇	☐
620022H102630A	3.0	1"x26	5	25
620022H103230A	3.0	1"x32	5	25

5S00.02 RACCORDO DIRITTO FEMMINA
FEMALE STRAIGHT FITTING



CODICE	+	Ø	◇	☐
5S0002H102630T	3.0	1"x26	5	40
5S0002H103230T	3.0	1"x32	5	30

6200.J4 TAPPO MASCHIO CON O-RING
MALE CAP WITH O-RING



CODICE	Ø	◇	☐
6200J4H100000A	1"	10	100

2600.41 TAPPO FEMMINA
FEMALE CAP



CODICE	Ø	◇	☐
260041H100000A	1"	10	100



**GENERAL
FITTINGS**
YOUNIQUE · ITALIAN



COLLETTORI IMPIANTI
RADIANTI

LOKI

COLLETTORI MODULARI IN OTTONE
MODULAR BRASS MANIFOLDS



ACCESSORI COLLETTORI PER RISCALDAMENTO HEATING MANIFOLD ACCESSORIES

General Fittings propone una vasta gamma di accessori e staffe per l'installazione dei collettori per riscaldamento.

General Fittings offers a wide range of accessories and brackets for the installation of heating manifolds.

VANTAGGI

- Completezza della gamma
- Un unico interlocutore per raccordi, tubi, collettori, accessori e attrezzature

ADVANTAGES

- *Complete range*
- *All in one partner for fittings, pipes, manifolds, accessories and tools.*

3500.G8FINALE M/F PER COLLETTORE
M/F END PIECE FOR MANIFOLD

CODICE	Ø	◇	☐
3500G8H050400A	3/4"x1/2"x3/8"	2	50
3500G8H100400A	1"x1/2"x3/8"	2	40
3500G8H120400A	1"1/4x1/2"x3/8"	2	30

3500.G8.NFINALE M/F NICHELATO PER COLLETTORE
NICKEL-PLATED M/F END PIECE FOR MANIFOLD

CODICE	Ø	◇	☐
3500G8N050400A	3/4"x1/2"x3/8"	2	50
3500G8N100400A	1"x1/2"x3/8"	2	40
3500G8N120400A	1"1/4x1/2"x3/8"	2	30

3500.G8.FFFINALE F/F PER COLLETTORE
F/F END PIECE FOR MANIFOLD

CODICE	Ø	◇	☐
3500G8H100401A	1"x1/2"x3/8"	2	30

3500.G8.N.FFFINALE F/F NICHELATO PER COLLETTORE
NICKEL-PLATED F/F END PIECE FOR MANIFOLD

CODICE	Ø	◇	☐
3500G8N100401A	1"x1/2"x3/8"	2	40

6500.H8RACCORDO SDOPPIATORE NICHELATO EUROCONO
EUROKONUS NICKEL-PLATED SPLITTER

CODICE	Ø	◇	☐
6500H8N050000H	3/4" EK	10	50

AC00.70 COIBENTAZIONE PER COLLETTORI
MANIFOLD INSULATION



CODICE		i	Ø
AC0070G061200H	12	fino ad esaurimento scorte	1"
AC0070G071200H	12		1" 1/4
AC0070G061300H	13		1"

6500.87 KIT TERMINALE PER COLLETTORI- SFIATO
AUTOMATICO
AUTOMATIC MANIFOLD TERMINAL KIT



CODICE	Ø	
650087N100000A	1"	12
650087N120000A	1"1/4	10

6500.87.N KIT TERMINALE PER COLLETTORI-SFIATO MANUALE
MANUAL MANIFOLD TERMINATION KIT



CODICE	Ø		
650087N100001A	1"	2	30
650087N120001A	1" 1/4	-	-

6500.42 REGOLATORE DI PORTATA
FLOW METER FOR MANIFOLDS



CODICE	i	Ø
650042H040000H	Plastica; per collettori THOR/ODINO	0x5 l/m
650042H04BRASS	Ottone; per collettori THOR/ODINO	0x5 l/m
6M0042H040000H	per collettori LOKI	0x5 l/m

7100.M6 VALVOLA A SFERA CON TERMOMETRO CON FARFALLA
BALL VALVE WITH THERMOMETER WITH BUTTERFLY



CODICE	i	Ø	◇	☐
7100M6N10102BA	Blu	1"	2	12
7100M6N10102RA	Rosso	1"	2	12
7100M6N12122BA	Blu	1"1/4	2	12
7100M6N12122RA	Rosso	1"1/4	2	12

7S00.M5 VALVOLA A SFERA M/F BOCCHETTONE CON FARFALLA
M/F STRAIGHT UNION BALL VALVE WITH BUTTERFLY

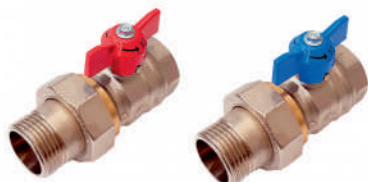

CODICE	i	Ø	◇	☐
7S00M5N1010B2A	Blu	1"	5	20
7S00M5N1010R2A	Rosso	1"	5	20
7100M5N1212B2A	Blu	1"1/4	-	10
7100M5N1212R2A	Rosso	1"1/4	-	10

7Y00.M5 VALVOLA A SFERA COMPATTA BOCCHETTONE CON FARFALLA SENZA TERMOMETRO
COMPACT BALL VALVE COUPLING WITH BUTTERFLY, WITHOUT THERMOMETER



CODICE	i	Ø	☐
7Y00M5N1010R2A	Rosso	1"	12
7Y00M5N1010B2A	Blu	1"	12

7Y00.M6 VALVOLA A SFERA COMPATTA BOCCHETTONE CON FARFALLA CON TERMOMETRO
COMPACT BALL VALVE COUPLING WITH BUTTERFLY AND THERMOMETER



CODICE	i	Ø	☐
7Y00M6N1010R2A	Rosso	1"	12
7Y00M6N1010B2A	Blu	1"	12

7Y00.M8 VALVOLA A SFERA COMPATTA A SQUADRA BOCCHETTONE CON FARFALLA NO TERMOMETRO
COMPACT 90-DEGREE BALL VALVE COUPLING WITH BUTTERFLY, NO THERMOMETER



CODICE	i	Ø	☐
7Y00M8N1010R2A	Rosso	1"	12
7Y00M8N1010B2A	Blu	1"	12

7Y00.Q8

VALVOLA A SFERA COMPATTA A SQUADRA
BOCCHETTONE CON FARFALLA CON TERMOMETRO
COMPACT 90-DEGREE BALL VALVE COUPLING WITH
BUTTERFLY AND THERMOMETER



CODICE	i	Ø	◇	☐
7Y00Q8N1010R2A	Rosso	1"	1	12
7Y00Q8N1010B2A	Blu	1"	-	12

7Y00.35

TERMOMETRO
THERMOMETER



CODICE	i	Ø
7Y0035P40120RH	0/80°C	Ø40

6500.35.SO

TERMOMETRO CON SONDA A CONTATTO
THERMOMETER WITH CONTACT PROBE



CODICE	Ø
650035HSOTERMH	-50°C ÷ +130°C

6500.35.SI

TERMOSTATO DI SICUREZZA
SAFETY THERMOSTAT



CODICE
650035HSITERMH

6500.75

RUBINETTO CARICO/SCARICO
CHARGE/DISCHARGE VALVE



CODICE	Ø	☐
650075N040000H	1/2"	50

6500.74.N

VALVOLA SFIATO AUTOMATICO NICHELATA
NICKEL-PLATED AUTOMATIC AIR VENT VALVE



CODICE	i	Ø	◇	☐
650074N030000H	fino ad esaurimento scorte	3/8"	10	20
650074N030001H		3/8"	10	-

2600.74 RUBINETTO SFIATO CALORIFERO TENUTA O-RING
AIR OUTLET VALVE WITH O-RING



CODICE	Ø	◇	☐
260074H010000H	1/8"	10	500
260074H020000H	1/4"	10	400
260074H030000H	3/8"	10	300
260074H040000H	1/2"	10	300

2600.74.N RUBINETTO SFIATO CALORIFERO NICHELATO
TENUTA O-RING
NICKEL-PLATED AIR OUTLET VALVE WITH O-RING



CODICE	Ø	◇	☐
260074N010000H	1/8"	10	500
260074N020000H	1/4"	10	400
260074N030000H	3/8"	10	300
260074N040000H	1/2"	10	300

2600.J4 TAPPO MASCHIO CON O-RING
MALE CAP WITH O-RING



CODICE	Ø	◇	☐
2600J4N100000A	1"	10	100
2600J4N120000A	1"1/4	10	60

6M00.87 TERMINALE PER COLLETTORI MODULARI LOKI
TERMINAL FOR LOKI MODULAR MANIFOLDS



CODICE	i	Ø	☐
6M0087H100000A	per collettore modulare LOKI	1"	12

RBS.30 VALVOLA SFIATO ARIA MANUALE CON O-RING,
TESTA IN ABS ORIENTABILE
MANUAL AIR VENT VALVE WITH O-RING, SWIVELLING
ABS HEAD



CODICE	Ø
RBS3000018N000	1/2"

RBS.45 VALVOLA NICHELATA CARICO/SCARICO ORIENTABILE CON O-RING E TAPPO
 NICKEL-PLATED LOADING/UNLOADING SWIVEL VALVE WITH O-RING AND PLUG



CODICE	Ø
RBS4500000000	1/2"x3/4"

7Y00.33 RACCORDO COLLETTORE NICHELATO
 NICKEL-PLATED MANIFOLD FITTING



CODICE	Ø
7Y0033N100000H	1"

SC6M.G8 FINALE PER COLLETTORE CON FASATURA SUL FILETTO
 THREADED END PIECE FOR MANIFOLD



CODICE	Ø
SC6MG8H100403A	1"x1/2"x3/8"

6500.00N RACCORDO M/M CON O-RING E GUARNIZIONE PIATTA
 MALE FITTING WITH O-RING AND FLAT GASKET



CODICE	Ø
650000N10100H	1"

AC00.80.I STAFFA PER COLLETTORI MODULARI LOKI
 BRACKET FOR LOKI MODULAR MANIFOLDS



CODICE	i	◇	☐
AC0080I10B290A	per collettore modulare LOKI	2	20

**AC00.80
BRACKET**

STAFFE PER COLLETTORI PER IMPIANTI DI RISCALDAMENTO
BRACKETS FOR MANIFOLDS FOR HEATING SYSTEMS



CODICE	■	H	∅	○	◇	□
AC00801100000H*	B=31 / C=90	A=200	1"	AC00801500000A-AC00801700000A-AC00801100000A	2	20
AC00801100001H*	C=80	A=210	1"	AC00801500000A-AC00801700000A-AC00801100000A	2	20
AC00801100002H**	B=18 / C=75	A=200	1"	AC00801500000A-AC00801700000A-AC00801100000A-AC00801500090H-AC00801700090H-AC00801850090H-AC00801100090H	2	20
AC00801120000H*	B=31 / C=100	A=200	1 1/4"	AC00801500000A-AC00801700000A-AC00801100000A	2	20
AC00801120002H**	B=18 / C=85	A=200	1 1/4"	AC00801500000A-AC00801700000A-AC00801100000A-AC00801500090H-AC00801700090H-AC00801850090H-AC00801100090H	2	20
AC008016M0000H**	B=18 / C=75	A=200	1"	AC00801500000A-AC00801700000A-AC00801100000A-AC00801500090A-AC00801700090A-AC00801850090A-AC00801100090A	2	20

*standard / **opzionale

*standard / **optional

AC00.80 CASE CASSETTA METALLICA PER COLLETTORE
METAL MANIFOLD CABINET



CODICE	∅	□
AC00801550090H	550x600x90	2-3-4-5
AC00801700090H	700x600x90	6-7-8-9
AC00801850090H	850x600x90	10-11
AC00801100090H	1000x600x90	12-13
AC00801500000A*	500x700x110	2-3-4-5
AC00801700000A*	700x700x110	6-7-8-9
AC00801100000A*	1000x700x110	10-11-12-13

*fino ad esaurimento scorte.

*until stocks are exhausted.

AC00801100000H-AC00801100002H
AC00801120000H-AC00801120002H-AC008016M0000H

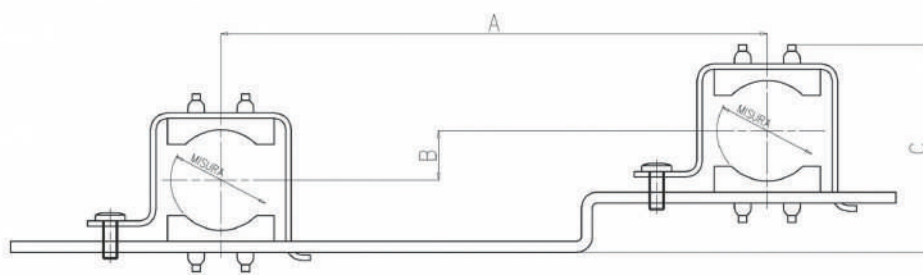

AC00801100001H

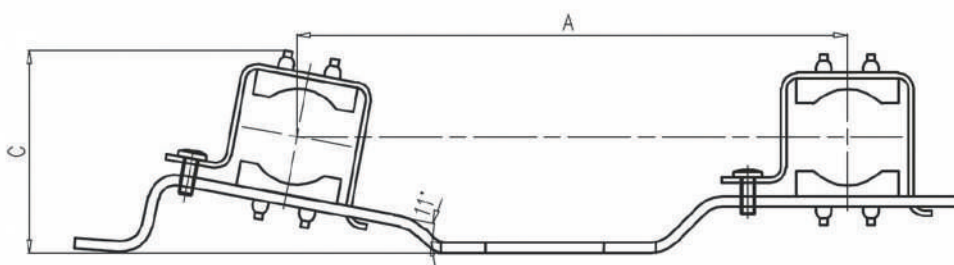

VALVOLE E
RUBINETTI
VALVES AND
TAPS



ZEFIRO

SERIE 7S00 LINE 7S00



Valvole a sfera passaggio standard- ISO 228/1 Standard bore ball valves - ISO 228/1

Le valvole a sfera a passaggio standard della SERIE 7S00 sono utilizzabili per la realizzazione di impianti di riscaldamento e raffrescamento, per installazioni sanitarie e ad aria compressa. Possono essere inoltre utilizzate in ogni tipo di installazione idraulica, commerciale, domestica, industriale e agricola e in linea di massima con fluidi non aggressivi.

Le filettature sono conformi alla UNI EN ISO 228-1:2003 "Filettatura di tubazioni per accoppiamento non a tenuta sul filetto".

Le valvole presentano estremità filettate F/F, M/F. Sono disponibili con leve in acciaio plastificato o farfalle in alluminio.

Standard bore ball valves of LINE 7S00 are suitable for the realization of heating and air conditioning systems, for sanitary and compressed air installations. They can also be used in any type of hydraulic installation (commercial, domestic, industrial and agricultural) and with non-aggressive fluids.

Threads complies with UNI EN ISO 228-1 law: "Piping thread for coupling not with tightness on the thread". Valves have F/F, M/F threads.

They are available with aluminium/steel lever or butterfly.









VANTAGGI

- Disponibile con leva acciaio e farfalla
- Interno non nichelato in accordo con le normative europee sull'acqua potabile
- Materie prime impiegate di alta qualità [UBA LIST]

ADVANTAGES





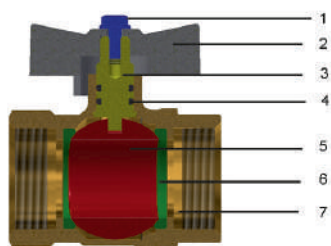

- Available with steel lever or steel butterfly
- Not nickel-plated inside in accordance with European regulations on drinking water
- Raw materials complying with UBA LIST

CAMPI DI APPLICAZIONI E PRESTAZIONI FIELDS OF APPLICATION

APPLICAZIONI APPLICATIONS		T. min.	T. max	Press.max Max. pressure
	acqua potabile drinking water	-20°C	+120°C	PN25-PN30 bar
	acqua calda sanitari hot sanitary water	-20°C	+120°C	PN25-PN30 bar
	raffrescamento cooling	-20°C	+120°C	PN25-PN30 bar
	radiatori radiators	-20°C	+120°C	PN25-PN30 bar
	riscaldamento a pavimento floor heating	-20°C	+120°C	PN25-PN30 bar
	irrigazione irrigation	-20°C	+120°C	PN25-PN30 bar
	aria compressa compressed air	-20°C	+120°C	PN25-PN30 bar
	-20°C: solo con liquido antigelo, glicole, in % max del 30% -20°C: only with antifreeze liquid (glycol) in % max of 30%			







COMPONENTI E MATERIALI VERSIONE CON FARFALLA BALL VALVES WITH BUTTERFLY: COMPONENTS AND MATERIALS

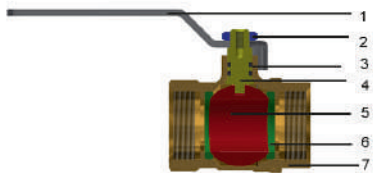

LEGENDA LEGEND	COMPONENTI COMPONENTS	MATERIALI MATERIALS
	1 Vite Screw	CB4F
	2 Farfalla Butterfly	Alluminio verniciato Coated aluminium
	3 Asta Stem	CW617N - UNI EN 12164 Brass CW617N - UNI EN 12164
	4 O-Ring Asta Stem O-Ring	Elastomero per acqua potabile Elastomer for drinking water
	5 Sfera Ball	CW617N - UNI EN 12165 Brass CW617N - UNI EN 12165
	6 Guarnizioni sfera Ball seal	PTFE
	7 Corpo/Manicotto Body	CW617N - UNI EN 12165 Brass CW617N - UNI EN 12165

COMPONENTI E MATERIALI VERSIONE CON LEVA BALLE VALVES WITH LEVER: COMPONENTS AND MATERIALS



LEGENDA LEGEND	COMPONENTI COMPONENTS	MATERIALI MATERIALS
	1 Leva Lever	Acciaio plastificato Plastic coated zinc plated steel
	2 Dado Nut	FE ZNB
	3 O-Ring Asta Stem O-Ring	Elastomero per acqua potabile Elastomer for drinking water
	4 Asta Stem	CW617N - UNI EN 12164 Brass CW617N - UNI EN 12164
	5 Sfera Ball	CW617N - UNI EN 12165 Brass CW617N - UNI EN 12165
	6 Guarnizione sfera Ball seal	PTFE
	7 Corpo/Manicotto Body	CW617N - UNI EN 12165 Brass CW617N - UNI EN 12165

DIMENSIONI DISPONIBILI AVAILABLE DIMENSIONS

Dimensioni Dimensions	PN
1/2"	PN 30
3/4"	PN 30
1"	PN 30
1 1/4"	PN 25
1 1/2"	PN 25
2"	PN 25

CERTIFICAZIONI CERTIFICATIONS

STATO COUNTRY	CERTIFICAZIONE CERTIFICATION	STATO COUNTRY	CERTIFICAZIONE CERTIFICATION	STATO COUNTRY	CERTIFICAZIONE CERTIFICATION
					
					
					

NORMATIVE

- UN EN ISO 228-1
Filettatura di tubazioni per accoppiamento non a tenuta sul filetto.
- UNI EN 13828
Rubinetti a sfera di leghe di rame e acciaio inossidabile a comando manuale per l'approvvigionamento di acqua potabile negli edifici.
- D.M. 174 (06/04/2004)
I materiali utilizzati sono conformi al Decreto Ministeriale n° 174 del 06/04/2004 [Regolamento concernente i materiali e gli oggetti che possono essere utilizzati negli impianti fissi di captazione, trattamento, adduzione e distribuzione delle acque destinate al consumo umano].
- Conforme a 4MS, UBA List (gruppo BC), DIN 50930/6 Dir. 2011/65/UE, 6C allegato III (RhOSII)

ISTRUZIONI DI MONTAGGIO

1. Le valvole possono essere installate in qualsiasi posizione, purchè siano visibili e facilmente accessibili e la leva di manovra sia libera e possa essere ruotata facilmente nelle posizioni di aperto e chiuso.
2. Direzione flusso: bidirezionale
3. Per la tenuta degli attacchi filettati della valvola alle tubazioni utilizzare mastici o nastri idonei.
4. L'impianto deve essere progettato e realizzato in modo da evitare sollecitazioni di flessione, torsione o altre forze che possano danneggiare la valvola, impedirne la tenuta e il corretto funzionamento
5. L'avvitamento alla tubazione deve avvenire con mezzi idonei utilizzando le estremità esagonali della valvola appositamente previste. La coppia di serraggio deve essere tale da garantire la tenuta senza deformare o rovinare alcuna parte della valvola.
6. Evitare qualsiasi manomissione delle valvole con particolare riferimento ai componenti che garantiscono la tenuta, agli organi di manovra ed ai fermi meccanici di apertura e chiusura.
7. Periodicamente eseguire cicli di apertura e chiusura valvola.

REGULATIONS

- UN EN ISO 228-1
Threads complies with UNI EN ISO 228-1:2003 law: "Piping thread for coupling not with tightness on the thread".
- UNI EN 13828
"Ball valves of copper alloys and stainless steel hand operated, for the supply of drinking water in buildings".
- D.M. 174 (06/04/2004)
Raw materials used are of high quality and comply with the Ministerial Decree N°174 dated 06/04/2004 concerning the materials and the items used in fixed installations for water collection, treatment and supply.
- Comply with 4MS, UBA List (BC group), DIN 50930/6 Dir. 2011/65/UE, 6C attachment III (RhOSII).

ASSEMBLY INSTRUCTIONS

1. The valves can be installed in any position, as long as they are visible and easily reachable and the operating lever is free and it can be turned without difficulties into the open and close position.
2. Bi-directional flow.
3. For the ball valve threading couplings to the pipes, please use suitable tapes.
4. The installation have to be planned and realized in order to avoid strain of flexion, torsion or other forces that could damage the valve, obstruct its tightness and its correct operating.
5. The screwing to the pipe have to be done by suitable tools, using valves hexagonal extremities specifically manufactured. The clamping couple have to guarantee the tightness without creaking or damage any part of the valves.
6. Avoid any valves damaging, especially for the components that guarantee the tightness, for operating organs and for mechanical locks and unlocks.
7. Operate periodically the valve with opening and closing cycles.

7S00.L1

VALVOLA A SFERA F/F CON LEVA ACCIAIO
F/F BALL VALVE WITH STEEL LEVER



CODICE	Ø	◇	☐
7S00L1N040400A	1/2"	15	60
7S00L1N050500A	3/4"	10	40
7S00L1N101000A	1"	6	24
7S00L1N121200A	1"1/4	-	20
7S00L1N141400A	1"1/2	-	15
7S00L1N202000A	2"	-	8

7S00.L2

VALVOLA A SFERA M/F CON LEVA ACCIAIO
M/F BALL VALVE WITH STEEL LEVER



CODICE	Ø	◇	☐
7S00L2N040400A	1/2"	15	60
7S00L2N050500A	3/4"	8	32
7S00L2N101000A	1"	6	24
7S00L2N121200A	1"1/4	-	20
7S00L2N141400A	1"1/2	-	12
7S00L2N202000A	2"	-	8

7S00.L5

VALVOLA A SFERA FEMMINA BOCCHETTONE CON
LEVA ACCIAIO
FEMALE STRAIGHT UNION BALL VALVE WITH STEEL
LEVER



CODICE	Ø	◇	☐
7S00L5N040402A	1/2"	10	40
7S00L5N050502A	3/4"	8	32
7S00L5N101002A	1"	4	16
7S00L5N121202A	1"1/4	-	16

7S00.M1

VALVOLA A SFERA F/F CON FARFALLA
F/F BALL VALVE WITH BUTTERFLY



CODICE	Ø	◇	☐
7S00M1N040400A	1/2"	20	80
7S00M1N050500A	3/4"	12	48
7S00M1N101000A	1"	8	32

7S00.M2

VALVOLA A SFERA M/F CON FARFALLA
M/F BALL VALVE WITH BUTTERFLY



CODICE	Ø	◇	☐
7S00M2N040400A	1/2"	20	80
7S00M2N050500A	3/4"	12	48
7S00M2N101000A	1"	8	32

7S00.M5

VALVOLA A SFERA M/F BOCCHETTONE CON
FARFALLA
M/F STRAIGHT UNION BALL VALVE WITH BUTTERFLY



CODICE	Ø	◇	☐
7S00M5N040402A	1/2"	12	48
7S00M5N050502A	3/4"	8	32
7S00M5N101002A	1"	5	20
7S00M5N121202A	1*1/4	-	20

7S00.M5

VALVOLA A SFERA M/F BOCCHETTONE CON
FARFALLA
M/F STRAIGHT UNION BALL VALVE WITH BUTTERFLY



CODICE	i	Ø	◇	☐
7S00M5N1010B2A	Blu	1"	5	20
7S00M5N1010R2A	Rosso	1"	5	20
7100M5N1212B2A	Blu	1*1/4	-	10
7100M5N1212R2A	Rosso	1*1/4	-	10



NOTO

SERIE 7100 LINE 7100



Valvole a sfera passaggio totale UNI EN ISO 228/1

Full bore ball valves - ISO 228/1

Le valvole a sfera a passaggio totale della SERIE 7100 sono utilizzabili per la realizzazione di impianti di riscaldamento e raffrescamento, per installazioni sanitarie e ad aria compressa. Possono essere inoltre utilizzate in ogni tipo di installazione idraulica, commerciale, domestica, industriale e agricola e in linea di massima con fluidi non aggressivi.

Le filettature sono conformi alla UNI EN ISO 228-1:2003 "Filettatura di tubazioni per accoppiamento non a tenuta sul filetto".

Le valvole presentano estremità filettate F/F, M/F o M/M. Sono disponibili con leve in acciaio plastificato o farfalle in alluminio

Full bore ball valves of LINE 7100 are suitable for the realization of heating and air conditioning systems, for sanitary and compressed air installations. They can also be used in any type of hydraulic installation (commercial, domestic, industrial and agricultural) and with non-aggressive fluids.

Threads complies with UNI EN ISO 228-1 law: "Piping thread for coupling not with tightness on the thread". Valves have F/F, M/F or M/M threads.

They are available with aluminium/steel lever or butterfly.









VANTAGGI

- Disponibile con leva acciaio, leva alluminio e farfalla
- Interno non nichelato in accordo con le normative europee sull'acqua potabile
- Materie prime impiegate di alta qualità [UBA LIST]

ADVANTAGES





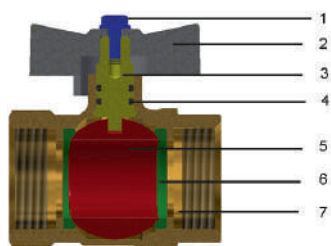

- Available with steel/aluminium lever or steel/aluminium butterfly
- Not nickel-plated inside in accordance with European regulations on drinking water
- Raw materials complying with UBA LIST

CAMPI DI APPLICAZIONI E PRESTAZIONI FIELDS OF APPLICATION

APPLICAZIONI APPLICATIONS		T. min.	T. max	Press.max Max. pressure
	acqua potabile drinking water	-20°C	+120°C	PN20 - PN25 - PN40
	acqua calda sanitari hot sanitary water	-20°C	+120°C	PN20 - PN25 - PN40
	raffrescamento cooling	-20°C	+120°C	PN20 - PN25 - PN40
	radiatori radiators	-20°C	+120°C	PN20 - PN25 - PN40
	riscaldamento a pavimento floor heating	-20°C	+120°C	PN20 - PN25 - PN40
	irrigazione irrigation	-20°C	+120°C	PN20 - PN25 - PN40
	aria compressa compressed air	-20°C	+120°C	PN20 - PN25 - PN40
	-20°C: solo con liquido antigelo, glicole, in % max del 30% -20°C: only with antifreeze liquid (glycol) in % max of 30%			







COMPONENTI E MATERIALI VERSIONE CON FARFALLA BALL VALVES WITH BUTTERFLY: COMPONENTS AND MATERIALS

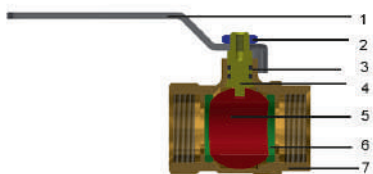

LEGENDA LEGEND	COMPONENTI COMPONENTS	MATERIALI MATERIALS
	1 Vite Screw	CB4F
	2 Farfalla Butterfly	All.verniciato Coated aluminium
	3 Asta Stem	CW617N - UNI EN 12164 Brass CW617N - UNI EN 12164
	4 O-Ring Asta Stem O-Ring	Elastomero per acqua potabile Elastomer for drinking water
	5 Sfera Ball	CW617N - UNI EN 12165 Brass CW617N - UNI EN 12165
	6 Guarnizioni sfera Ball seal	PTFE
	7 Corpo/Manicotto Body	CW617N - UNI EN 12165 Brass CW617N - UNI EN 12165

COMPONENTI E MATERIALI VERSIONE CON LEVA BALLE VALVES WITH LEVER: COMPONENTS AND MATERIALS



LEGENDA LEGEND	COMPONENTI COMPONENTS	MATERIALI MATERIALS
	1 Leva Lever	Acciaio plastificato/Alluminio Plastic coated zinc plated steel/Aluminium
	2 Dado Nut	FE ZNB
	3 O-Ring Asta Stem O-Ring	Elastomero per acqua potabile Elastomer for drinking water
	4 Asta Stem	CW617N - UNI EN 12164 Brass CW617N - UNI EN 12164
	5 Sfera Ball	CW617N - UNI EN 12165 Brass CW617N - UNI EN 12165
	6 Guarnizioni sfera Ball seal	PTFE
	7 Corpo/Manicotto Body	CW617N - UNI EN 12165 Brass CW617N - UNI EN 12165

CERTIFICAZIONI CERTIFICATIONS

STATO COUNTRY	CERTIFICAZIONE CERTIFICATION	STATO COUNTRY	CERTIFICAZIONE CERTIFICATION	STATO COUNTRY	CERTIFICAZIONE CERTIFICATION
					
					
					

DIMENSIONI DISPONIBILI AVAILABLE DIMENSIONS

Dimensioni Dimensions	PN
1/2"	PN 40
3/4"v	PN 40
1"	PN 40
1"1/4	PN 25
1"1/2	PN 25
2"	PN 25
2"1/2	PN 20
3"	PN 20
4"	PN 20

NORMATIVE

- UN EN ISO 228-1
Filettatura di tubazioni per accoppiamento non a tenuta sul filetto
- UNI EN 13828
Rubinetti a sfera di leghe di rame e acciaio inossidabile a comando manuale per l'approvvigionamento di acqua potabile negli edifici
- D.M. 174 (06/04/2004)
I materiali utilizzati sono conformi al Decreto Ministeriale n° 174 del 06/04/2004 [Regolamento concernente i materiali e gli oggetti che possono essere utilizzati negli impianti fissi di captazione, trattamento, adduzione e distribuzione delle acque destinate al consumo umano]
- Conforme a 4MS, UBA List (gruppo BC), DIN 50930/6 Dir. 2011/65/UE, 6C allegato III (RhOSII)

REGULATIONS

- UN EN ISO 228-1
Threads complies with UNI EN ISO 228-1 law: "Piping thread for coupling not with tightness on the thread".
- UNI EN 13828
"Ball valves of copper alloys and stainless steel hand operated, for the supply of drinking water in buildings".
- D.M. 174 (06/04/2004)
Raw materials used are of high quality and comply with the Ministerial Decree N°174 dated 06/04/2004 concerning the materials and the items used in fixed installations for water collection, treatment and supply.
- Comply with 4MS, UBA List (BC group), DIN 50930/6 Dir. 2011/65/UE, 6C attachment III (RhOSII).

ISTRUZIONI DI MONTAGGIO

1. Le valvole possono essere installate in qualsiasi posizione, purchè siano visibili e facilmente accessibili e la leva di manovra sia libera e possa essere ruotata facilmente nelle posizioni di aperto e chiuso.
2. Direzione flusso: bidirezionale
3. Per la tenuta degli attacchi filettati della valvola alle tubazioni utilizzare mastici o nastri idonei.
4. L'impianto deve essere progettato e realizzato in modo da evitare sollecitazioni di flessione, torsione o altre forze che possano danneggiare la valvola, impedirne la tenuta e il corretto funzionamento
5. L'avvitamento alla tubazione deve avvenire con mezzi idonei utilizzando le estremità esagonali della valvola appositamente previste. La coppia di serraggio deve essere tale da garantire la tenuta senza deformare o rovinare alcuna parte della valvola.
6. Evitare qualsiasi manomissione delle valvole con particolare riferimento ai componenti che garantiscono la tenuta, agli organi di manovra ed ai fermi meccanici di apertura e chiusura.
7. Periodicamente eseguire cicli di apertura e chiusura valvola.

ASSEMBLY INSTRUCTIONS

1. The valves can be installed in any position, as long as they are visible and easily reachable and the operating lever is free and it can be turned without difficulties into the open and close position.
2. Bi-directional flow.
3. For the ball valve threading couplings to the pipes, please use suitable tapes.
4. The installation have to be planned and realized in order to avoid strain of flexion, torsion or other forces that could damage the valve, obstruct its tightness and its correct operating.
5. The screwing to the pipe have to be done by suitable tools, using valves hexagonal extremities specifically manufactured. The clamping couple have to guarantee the tightness without creaking or damage any part of the valves.
6. Avoid any valves damaging, especially for the components that guarantee the tightness, for operating organs and for mechanical locks and unlocks.
7. Operate periodically the valve with opening and closing cycles.

7100.L1

VALVOLA A SFERA F/F CON LEVA ACCIAIO
F/F BALL VALVE WITH STEEL LEVER



CODICE	Ø	◇	☐
7100L1N040400A	1/2"	12	72
7100L1N050500A	3/4"	8	48
7100L1N101000A	1"	6	36
7100L1N121200A	1"1/4	-	12
7100L1N141400A	1"1/2	-	6
7100L1N202000A	2"	-	4
7100L1N242400A	2"1/2	-	3
7100L1N303000A	3"	-	2
7100L1N404000A	4"	-	-

7100.L2

VALVOLA A SFERA M/F CON LEVA ACCIAIO
M/F BALL VALVE WITH STEEL LEVER



CODICE	Ø	◇	☐
7100L2N040400A	1/2"	12	72
7100L2N050500A	3/4"	8	48
7100L2N101000A	1"	6	36
7100L2N121200A	1"1/4	-	10
7100L2N141400A	1"1/2	-	6
7100L2N202000A	2"	-	4

7100.L3

VALVOLA A SFERA M/M CON LEVA ACCIAIO
M/M BALL VALVE WITH STEEL LEVER



CODICE	Ø	◇	☐
7100L3N040400A	1/2"	12	72
7100L3N050500A	3/4"	8	48
7100L3N101000A	1"	6	36

7100.L5

VALVOLA A SFERA FEMMINA BOCCHETTONE CON
LEVA ACCIAIO
FEMALE STRAIGHT UNION BALL VALVE WITH STEEL
LEVER



CODICE	Ø	◇	☐
7100L5N040401A	1/2"	10	60
7100L5N050501A	3/4"	10	30
7100L5N101001A	1"	6	18
7100L5N121201A	1"1/4	-	6
7100L5N141401A	1"1/2	-	4
7100L5N202001A	2"	-	2

7100.M1VALVOLA A SFERA F/F CON FARFALLA ALLUMINIO
F/F BALL VALVE WITH ALUMINIUM BUTTERFLY

CODICE	Ø	◇	☐
7100M1N040400A	1/2"	12	72
7100M1N050500A	3/4"	8	48
7100M1N101000A	1"	6	36

7100.M3VALVOLA A SFERA M/M CON FARFALLA ALLUMINIO
M/M BALL VALVE WITH ALUMINIUM BUTTERFLY

CODICE	Ø	◇	☐
7100M3N040400A	1/2"	12	72
7100M3N050500A	3/4"	8	48
7100M3N101000A	1"	6	36

7100.M2VALVOLA A SFERA M/F CON FARFALLA ALLUMINIO
M/F BALL VALVE WITH ALUMINIUM BUTTERFLY

CODICE	Ø	◇	☐
7100M2N040400A	1/2"	12	72
7100M2N050500A	3/4"	8	48
7100M2N101000A	1"	6	36

7100.M5VALVOLA A SFERA M/F BOCCHETTONE CON
FARFALLA
M/F STRAIGHT UNION BALL VALVE WITH BUTTERFLY

CODICE	Ø	◇	☐
7100M5N040401A	1/2"	10	60
7100M5N050501A	3/4"	10	30
7100M5N101001A	1"	7	21
7100M5N121201A	1"1/4	-	10

7100.M8

SQUADRA M/F BOCCHETTONE CON FARFALLA
M/F ANGLE WITH NUT AND TAIL WITH BUTTERFLY



CODICE	Ø	◇	☐
7100M8N040400A	1/2"	10	60
7100M8N050500A	3/4"	10	30
7100M8N101000A	1"	5	15

7A00.L1

VALVOLA A SFERA F/F CON LEVA ALLUMINIO
F/F BALL VALVE WITH ALUMINIUM LEVER



CODICE	Ø	◇	☐
7A00L1N040400A	1/2"	12	72
7A00L1N050500A	3/4"	8	48
7A00L1N101000A	1"	6	36
7A00L1N121200A	1"1/4	-	10
7A00L1N141400A	1"1/2	-	6
7A00L1N202000A	2"	-	4
7A00L1N242400A	2"1/2	-	3
7A00L1N303000A	3"	-	-
7A00L1N404000A	4"	-	-

Disponibile a richiesta

Available on demand

7A00.L2

VALVOLA A SFERA M/F CON LEVA ALLUMINIO
M/F BALL VALVE WITH ALUMINIUM LEVER



CODICE	Ø	◇	☐
7A00L2N040400A	1/2"	12	72
7A00L2N050500A	3/4"	8	48
7A00L2N101000A	1"	6	36
7A00L2N121200A	1"1/4	-	10
7A00L2N141400A	1"1/2	-	6
7A00L2N202000A	2"	-	4

Disponibile a richiesta

Available on demand

7A00.L3

VALVOLA A SFERA M/M CON LEVA ALLUMINIO
M/M BALL VALVE WITH ALUMINIUM LEVER



CODICE	Ø	◇	☐
7A00L3N040400A	1/2"	6	36
7A00L3N050500A	3/4"	8	48
7A00L3N101000A	1"	6	36

Disponibile a richiesta

Available on demand

7A00.L5 VALVOLA A SFERA FEMMINA BOCCHETTONE
 ALLUMINIO
 FEMALE STRAIGHT UNION BALL VALVE WITH
 ALUMINIUM LEVER



CODICE	Ø	◇	☐
7A00L5N040401A	1/2"	10	60
7A00L5N050501A	3/4"	10	30
7A00L5N101001A	1"	6	18
7A00L5N121201A	1"1/4	-	6
7A00L5N141401A	1"1/2	-	4
7A00L5N202001A	2"	-	2

Disponibile a richiesta

Available on demand

7100.74 RUBINETTO DA GIARDINO STANDARD
STANDARD STANDARD GARDEN TAP



CODICE	Ø	◇	☐
710074N04000LA	1/2"	6	36
710074N05000LA	3/4"	10	30

NOTO



Valvole a sfera passaggio totale - ISO 228/1

Full bore ball valves - ISO 228/1





VALVOLE E FILTRI

VALVES AND FILTERS

General Fittings completa l'offerta delle valvole con mini valvole a sfera, valvole a saracinesca, valvole di ritegno e raccoglitori di impurità.

General Fittings completes the offer of valves with mini ball valves, gate valves, check valves and Y pattern filters.

7Y00.R7

VALVOLA DI RITEGNO UNIVERSALE F/F CON
OTTURATORE IN COPOLIMERO D'ACETALE (POM)
F/F UNIVERSAL CHECK VALVE WITH ACETAL
COPOLYMER (POM) SHUTTER



CODICE	Ø	
7Y00R7H040400H	1/2"	60
7Y00R7H050500H	3/4"	36
7Y00R7H101000H	1"	28
7Y00R7H121200H	1"1/4	12
7Y00R7H141400H	1"1/2	10
7Y00R7H202000H	2"	6

7Y00.J8

RACCOGLITORE DI IMPURITA' A Y
BRASS Y PATTERN FILTER





CODICE	Ø	
7Y00J8H04040BH	1/2"	60
7Y00J8H05050BH	3/4"	30
7Y00J8H10100BH	1"	20
7Y00J8H12120BH	1"1/4	10
7Y00J8H14140BH	1"1/2	6
7Y00J8H20200BH	2"	3

7Y00.J7

VALVOLA DI RITEGNO UNIVERSALE F/F CON
OTTURATORE IN OTTONE PER PRESSIONI ELEVATE
F/F UNIVERSAL CHECK VALVE WITH BRASS SHUTTER
FOR HIGH PRESSURE



CODICE	Ø		
7Y00J7H040400A	1/2"	-	40
7Y00J7H050500A	3/4"	12	24
7Y00J7H101000A	1"	-	16
7Y00J7H121200A	1"1/4	-	15
7Y00J7H141400A	1"1/2	-	10
7Y00J7H202000A	2"	-	5

7Y00.J6

SARACINESCA IN OTTONE TIPO NORMALE F/F
F/F BRASS GATE VALVE NORMAL TYPE



CODICE	Ø	
7Y00J6H040400H	1/2"	40
7Y00J6H050500H	3/4"	20
7Y00J6H101000H	1"	10
7Y00J6H121200H	1"1/4	10
7Y00J6H141400H	1"1/2	5
7Y00J6H202000H	2"	4
7Y00J6H242400H	2"1/2	2
7Y00J6H303000H	3"	2
7Y00J6H404000H	4"	-

7800.L2

MINI VALVOLA M/F
M/F MINI BALL VALVE



CODICE	i	Ø	◇	☐
7800L2N040400A	Leva nera	1/2"	25	150
7800L2N04040BA	Leva blu	1/2"	25	150
7800L2N04040RA	Leva rossa	1/2"	25	150

7800.L1

MINI VALVOLA NICHELATA F/F CON LEVA NERA
F/F NICKEL-PLATED MINI VALVE WITH BLACK LEVER



CODICE	Ø	◇	☐
7800L1N040400H	1/2"	25	150

7Y00.M9

VALVOLA F/F CON GIRELLO CON FARFALLA
F/F VALVE WITH LOOSE NUT AND FLAT WASHER,
WITH BUTTERFLY

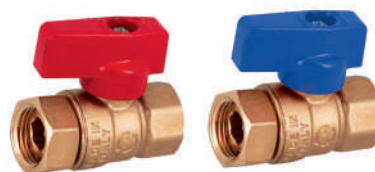

CODICE	i	Ø	◇	☐
7Y00M9H04040RA	Rossa	1/2"	20	120
7Y00M9H04040BA	Blu	1/2"	20	120
7Y00M9H05050RA	Rossa	3/4"	25	75
7Y00M9H05050BA	Blu	3/4"	25	75

IDROS

RUBINETTI SOTTOLAVABO ANGLE VALVES



I rubinetti sottolavabo per idrosanitaria sono utilizzabili per adduzione acqua calda e fredda in impianti idrico-sanitari e in ogni tipo di installazione idraulica domestica, commerciale, industriale.

Angle valves are suitable for cold and hot water supply for any kind of sanitary systems, such as domestic, commercial, industry installations.



VANTAGGI

- Ampiezza gamma
- Materie prime impiegate di alta qualità [UBA LIST]
- Manopola rubinetti sia in ABS che in metallo

ADVANTAGES

- *Wide range*
- *Raw materials complying with UBA LIST*
- *Available with metal and ABS handle*

CAMPI DI APPLICAZIONI E PRESTAZIONI FIELDS OF APPLICATION

APPLICAZIONI APPLICATIONS		T. min.	T. max	Press.max Max. pressure
	acqua potabile drinking water	+5°C	+80°C	10 bar
	acqua calda sanitari hot sanitary water	+5°C	+80°C	10 bar

FILETTATURA E SERRAGGIO DADI THREADS AND NUTS TIGHTENING

Ø	Attacco filetto Thread coupling	N° Giri (+1/4) N° Turns (+1/4)
Ø 8	3/8"	3/4
Ø 10	3/8"	3/4

NORMATIVE

- UNI EN 1254-2

I raccordi sono conformi alla norma UNI EN 1254-2: "Raccorderia idraulica per tubazioni rame con terminali a compressione."

- UNI EN ISO 228-1:2003

Tutte le filettature sono conformi alla norma UNI EN ISO 228-1:2003: "Filettatura di tubazioni per accoppiamento non a tenuta sul filetto".

- D.M. 174 (06/04/2004)

I materiali utilizzati sono conformi al Decreto Ministeriale n° 174 del 06/04/2004 [Regolamento concernente i materiali e gli oggetti che possono essere utilizzati negli impianti fissi di captazione, trattamento, adduzione e distribuzione delle acque destinate al consumo umano].

- Conforme a 4MS, UBA List (gruppo BC), DIN 50930/6 Dir. 2011/65/UE, 6C allegato III (RhOSII)

REGULATIONS

- UNI EN 1254-2

Fittings comply with UNI EN 1254-2 law: "Plumbing fittings - Fittings with compression ends for use with copper tubes."

- UNI EN ISO 228-1:2003

Threads complies with UNI EN ISO 228-1:2003 law: "Piping thread for coupling not with tightness on the thread".

- D.M. 174 (06/04/2004)

Raw materials used are of high quality and comply with the Ministerial Decree N°174 dated 06/04/2004 concerning the materials and the items used in fixed installations for water collection, treatment and supply.

- Comply with 4MS, UBA List (BC group), DIN 50930/6 Dir. 2011/65/UE, 6C attachment III (RhOSII).

CERTIFICAZIONI CERTIFICATIONS

STATO COUNTRY	CERTIFICAZIONE CERTIFICATION	STATO COUNTRY	CERTIFICAZIONE CERTIFICATION	STATO COUNTRY	CERTIFICAZIONE CERTIFICATION
					
					
					

1400.49 RUBINETTO SOTTOLAVABO CROMATO CON ROSONE E MANOPOLA TRIANGOLARE
CHROME-PLATED ANGLE VALVE WITH ROSETTE AND TRIANGULAR HANDLE



CODICE	i	Ø	
140049C040400A	ABS	1/2"x1/2"	24
140049C0404Z0A	ZAMA	1/2"x1/2"	24

**1400.49
DOUBLE** RUBINETTO SOTTOLAVABO DOPPIO CROMATO CON ROSONE E MANOPOLA TRIANGOLARE
CHROME-PLATED DOUBLE ANGLE VALVE WITH ROSETTE AND TRIANGULAR HANDLE



CODICE	i	Ø	
140049C040404A	ABS	1/2"x1/2"	12
140049C0404Z4A	ZAMA	1/2"x1/2"	12

1400.74 RUBINETTO SOTTOLAVABO CROMATO CON ROSONE
CHROME-PLATED ANGLE VALVE WITH ROSETTE



CODICE	Ø		
140074C040300A	1/2"x3/8" H=89,5	-	24
140074C040400A	1/2"x1/2" H=89,5	2	24

1400.74 RUBINETTO SOTTOLAVABO CROMATO CON ROSONE
CHROME-PLATED ANGLE VALVE WITH ROSETTE



CODICE	Ø		
140074C040459A	1/2"x1/2" H=72	-	40

**1400.74
COMPLETE** RUBINETTO SOTTOLAVABO CROMATO CON ROSONE, DADO E CARTUCCIA
CHROME-PLATED DOUBLE ANGLE VALVE WITH ROSETTE, NUT AND OLIVE



CODICE	Ø	
140074C040310A	1/2"x3/8"x10	24

**1400.74
DOUBLE** RUBINETTO SOTTOLAVABO DOPPIO CROMATO CON ROSONE
CHROME-PLATED DOUBLE ANGLE VALVE WITH ROSETTE



CODICE	Ø	
140074C040404A	1/2"x1/2"	12

1400.N1

RUBINETTO SOTTOLAVABO CON FILTRO, SNODO E
ROSONE
ANGLE VALVE WITH FILTER, JOINT AND ROSETTE



CODICE



1400N1C041000A

1/2"x10

25

EB00.84

ROSONE
ROSETTE



CODICE



EB0084I045700H

1/2"D.57

1400.Q6

RUBINETTO SOTTOLAVABO CROMATO CON ROSONE
CHROME-PLATED ANGLE VALVE WITH ROSETTE



CODICE



1400Q6C040400A

1/2"x1/2"

2

48

1400.E4

DADO 10 MM E GUARNIZIONE
10 MM NUT AND GASKET



CODICE



1400E4C031000H

3/8"x10

10

500



IDROS



RUBINETTI LAVATRICE WASHING MACHINE TAPS



Rubinetto a sfera in ottone cromato con attacco per lavatrice e rosetta integrata utilizzabile per adduzione acqua calda e fredda in impianti idrico-sanitari.

Chromed brass ball tap with washing machine connection for hot and cold water supply in plumbing and sanitary systems.

CAMPI DI APPLICAZIONI E PRESTAZIONI FIELDS OF APPLICATION

APPLICAZIONI APPLICATIONS		T. min.	T. max	Press.max Max. pressure
	acqua potabile drinking water	+5°C	+90°C	10 bar
	acqua calda sanitari hot sanitary water	+5°C	+90°C	10 bar

COMPONENTI E MATERIALI COMPONENTS AND MATERIALS

COMPONENTI COMPONENTS	MATERIALI MATERIALS
Asta Stem	CW617N - UNI EN 12164 Brass CW617N - UNI EN 12164
Corpo Body	CW617N - UNI EN 12165 cromato CW617N - UNI EN 12165 chromed
Sfera Ball	CW617N UNI-EN 12164 nichelata CW617N UNI-EN 12164 nickel plated
O-Ring asta Stem O-Ring	Elastomero Elastomer
Leva Lever	ZAMA ZAMAK
O-ring sfera Ball O-Ring	Elastomero Elastomer
Rosone Rosette	Acciaio Inox Stainless steel

NORMATIVE

- D.M. 174 (06/04/2004)

I materiali utilizzati sono conformi al Decreto Ministeriale n° 174 del 06/04/2004 [Regolamento concernente i materiali e gli oggetti che possono essere utilizzati negli impianti fissi di captazione, trattamento, adduzione e distribuzione delle acque destinate al consumo umano]

- UNI EN ISO 228-1:2003

Tutte le filettature sono conformi alla norma UNI EN ISO 228-1:2003: "Filettatura di tubazioni per accoppiamento non a tenuta sul filetto"

- Conforme a 4MS, UBA List (gruppo BC), DIN 50930/6 Dir. 2011/65/UE, 6C allegato III (RhOSII)

REGULATIONS

- D.M. 174 (06/04/2004)

Raw materials used are of high quality and comply with the Ministerial Decree N°174 dated 06/04/2004 concerning the materials and the items used in fixed installations for water collection, treatment and supply.

- UNI EN ISO 228-1:2003

Threads complies with UNI EN ISO 228-1:2003 law: "Piping thread for coupling not with tightness on the thread".

- Comply with 4MS, UBA List (BC group), DIN 50930/6 Dir. 2011/65/UE, 6C attachment III (RhOSII).

1400.78

RUBINETTO A SFERA CROMATO PER LAVATRICE
CHROME-PLATED WASHING MACHINE BALL VALVE



CODICE

Ø



140078C040500A

1/2"x3/4"

35

1400.L9

RUBINETTO LAVATRICE A "T" CROMATO
CHROME WASHING MACHINE "T" TAP



CODICE

Ø



1400L9C040504A

1/2"x3/4"x1/2"

35

VALVOLE PER
RADIATORE
RADIATOR
VALVES





SERIE 7E00 LINE 7E00



Valvole e detentori per radiatore Valves and lockshields for radiator

Le valvole sono dispositivi di intercettazione di fluidi come acqua calda e fredda negli impianti di riscaldamento e raffreddamento.

Le valvole sono disponibili in tutte le figure, con attacchi filettati femmina o Eurocono. Oltre alla valvola di ingresso al corpo scaldante, è opportuno installare in uscita un detentore con funzioni di intercettazione e regolazione. I detentori General Fittings hanno l'interasse uguale alla corrispondente valvola di ingresso.

Le linee lisce ed arrotondate della serie 7E00 si presentano esteticamente gradevoli, grazie all'utilizzo di una manopola ad incastro. A livello tecnico la serie 7E00 presenta una chiusura a doppia tenuta, a garanzia di una maggior sicurezza. La chiusura è infatti sia tramite O-Ring che di tipo Metallo / Metallo.

Valves are devices for the interception of fluids such as hot and cold water in heating and cooling systems.

The valves are available in all figures, with female or Euroconus threaded connections. In addition to the inlet valve to the heating body, a lockshield valve with interception and regulation functions should be installed at the outlet. General Fittings lockshields have the center distance equal to the corresponding inlet valve.

The smooth and rounded lines of 7E00 valves are aesthetically pleasing, thanks to the development of an interlocking knob. On a technical level the 7E00 series has a double sealing closure, which is granting a greater safety. The closure of the valve is in fact guaranteed by an O-Ring as well as Metal-to-Metal tightening.

VANTAGGI

- Ampia gamma
- Chiusura a doppia tenuta (O-Ring + metallo/metallo) per una maggiore sicurezza
- Manopola ad incastro
- Materie prime impiegate di alta qualità [UBA LIST]

ADVANTAGES





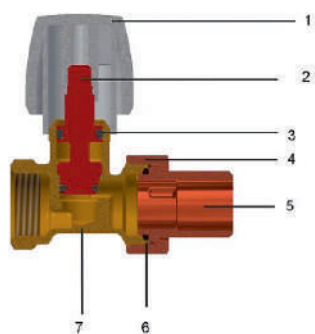

- Wide range
- Double sealing: O-Ring as well as Metal-to-Metal tightening for increased security
- Handle without visible screw
- Raw materials complying with UBA LIST

CAMPI DI APPLICAZIONI E PRESTAZIONI FIELDS OF APPLICATION

APPLICAZIONI APPLICATIONS	T min.	T. max	Press.max Max. pressure	Press.diff. Diff. press.
 radiatori radiators	-20°C	+100°C	10 bar	1 bar
-20°C: solo con liquido antigelo, glicole, in % max del 30% -20°C: only with antifreeze liquid (glycol) in % max of 30%				



COMPONENTI E MATERIALI VALVOLA VALVE: COMPONENTS AND MATERIALS

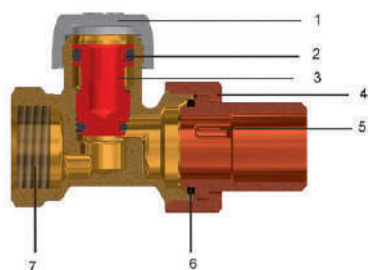

LEGENDA LEGEND	COMPONENTI COMPONENTS	MATERIALI MATERIALS
	1 Manopola Handle	ABS bianco RAL 9010 ABS white RAL 9010
	2 Asta Stem	CW617N - UNI EN 12164 Brass CW617N - UNI EN 12164
	3 O-Ring asta/otturatore Stem O-Ring	Elastomero Elastomer
	4 Dado Nut	CW617N - UNI EN 12165 Brass CW617N - UNI EN 12165
	5 Codolo Pipe union	CW617N - UNI EN 12164 Brass CW617N - UNI EN 12164
	6 O-Ring codolo O-Ring pipe union	Elastomero Elastomer
	7 Corpo Body	CW617N - UNI EN 12165 Brass CW617N - UNI EN 12165

COMPONENTI E MATERIALI DETENTORE LOCKSHIELD: COMPONENTS AND MATERIALS



LEGENDA LEGEND	COMPONENTI COMPONENTS	MATERIALI MATERIALS
	1 Manopola Handle	ABS bianco RAL 9010 ABS white RAL 9010
	2 O-Ring asta/otturatore Stem O-Ring	Elastomero Elastomer
	3 Otturatore Shutter	CW617N - UNI EN 12164 Brass CW617N - UNI EN 12164
	4 Dado Nut	CW617N - UNI EN 12165 Brass CW617N - UNI EN 12165
	5 Codolo Pipe union	CW617N - UNI EN 12164 Brass CW617N - UNI EN 12164
	6 O-Ring codolo O-Ring pipe union	Elastomero Elastomer
	7 Corpo Body	CW617N - UNI EN 12165 Brass CW617N - UNI EN 12165

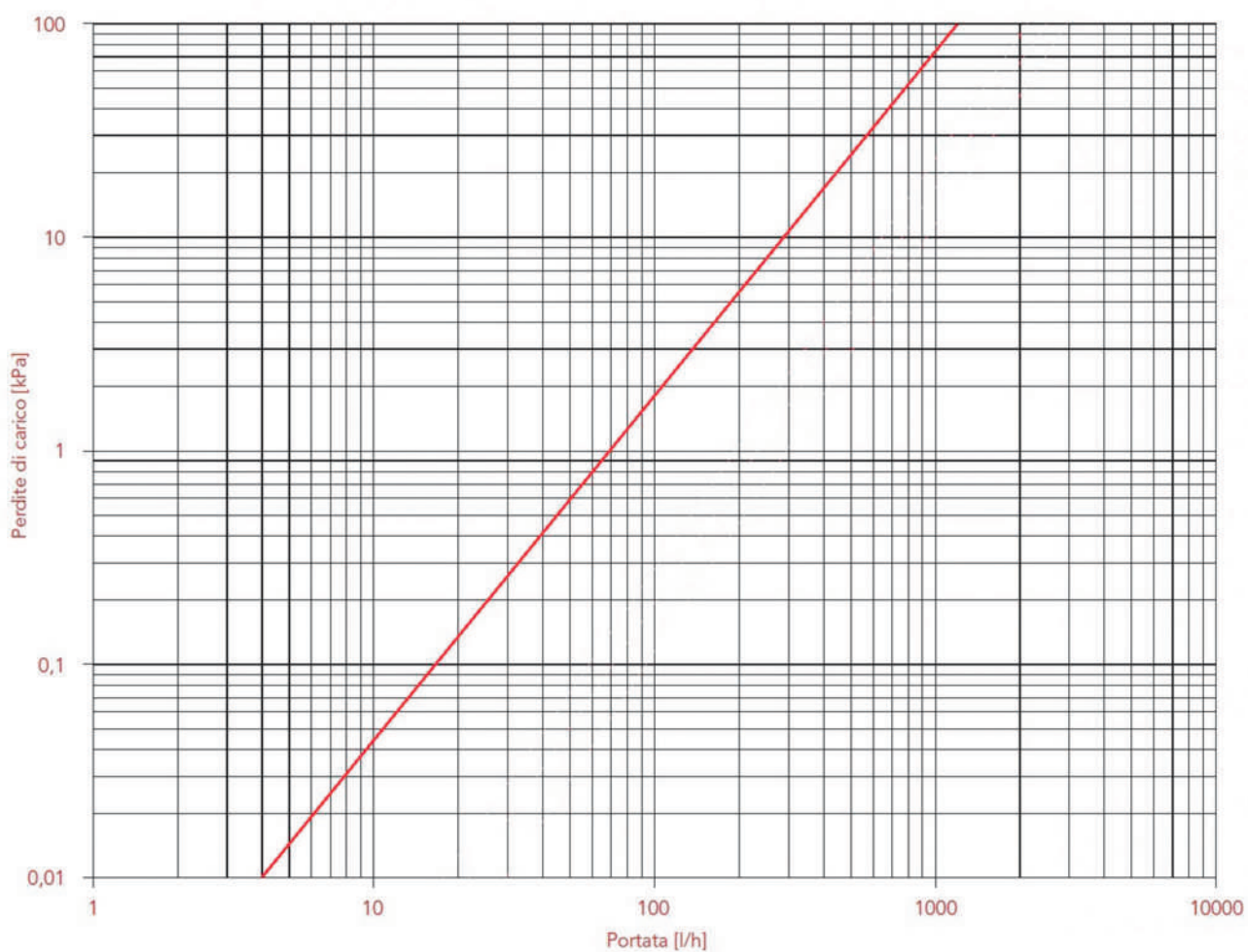

Kv 1.25









NORMATIVE

- UN EN ISO 228-1
Filettatura di tubazioni per accoppiamento non a tenuta sul filetto

REGULATIONS

- UN EN ISO 228-1
Threads complies with UNI EN ISO 228-1:2003 law: "Piping thread for coupling not with tightness on the thread"

CERTIFICAZIONI CERTIFICATIONS

STATO COUNTRY	CERTIFICAZIONE CERTIFICATION	STATO COUNTRY	CERTIFICAZIONE CERTIFICATION	STATO COUNTRY	CERTIFICAZIONE CERTIFICATION
					
					

7E00.75 VALVOLA DIRITTA CON ATTACCO PER TUBO FERRO
STRAIGHT VALVE WITH IRON PIPE CONNECTION



CODICE	i	Ø	
7E0075N040400A		1/2"	25
7E0075N04040RA	monocono	1/2"	25

7E00.75-90° EK VALVOLA A SQUADRA CON ATTACCO EUROCONO
ANGLE VALVE EUROCONE CONNECTION



CODICE	i	Ø	
7E0075N050490A		3/4"EKx1/2"	25
7E0075N05049RA	monocono	3/4"EKx1/2"	25

7E00.75 EK VALVOLA DIRITTA CON ATTACCO EUROCONO
STRAIGHT VALVE EUROCONE CONNECTION



CODICE	i	Ø	
7E0075N050400A		3/4"EKx1/2"	25
7E0075N05040RA	monocono	3/4"EKx1/2"	25

7E00.J9 EK DETENTORE DIRITTO CON ATTACCO EUROCONO
STRAIGHT LOCKSHIELD EUROCONE CONNECTION



CODICE	i	Ø	
7E00J9N050400A		3/4"EKx1/2"	25
7E00J9N05040RA	monocono	3/4"EKx1/2"	25

7E00.75-90° VALVOLA A SQUADRA CON ATTACCO PER TUBO FERRO
ANGLE VALVE WITH IRON PIPE CONNECTION



CODICE	i	Ø	
7E0075N040490A		1/2"	25
7E0075N04049RA	monocono	1/2"	25

7E00.J9 DETENTORE DIRITTO CON ATTACCO PER TUBO FERRO
STRAIGHT LOCKSHIELD WITH IRON PIPE CONNECTION



CODICE	i	Ø	
7E00J9N040400A		1/2"	25
7E00J9N04040RA	monocono	1/2"	25

7E00.J9-90° DETENTORE A SQUADRA CON ATTACCO PER TUBO FERRO
 ANGLE LOCKSHIELD WITH IRON PIPE CONNECTION



CODICE	i	Ø	
7E00J9N040490A		1/2"	25
7E00J9N04049RA	monocono	1/2"	25



7E00.J9-90° EK DETENTORE A SQUADRA CON ATTACCO EUROCONO
 ANGLE LOCKSHIELD EUROCONE CONNECTION



CODICE	i	Ø	
7E00J9N050490A		3/4"EKx1/2"	25
7E00J9N05049RA	monocono	3/4"EKx1/2"	25



7E00.E3 STRAIGHT VALVOLA H DIRITTA CON KIT NIPLI/ADATTATORI
 H STRAIGHT VALVE WITH NIPPLES/ADAPTERS KIT



CODICE		Ø	
7E00E3N050500A	50 mm	3/4"x3/4"	25

7E00.E3 ANGLE VALVOLA H ANGOLO CON KIT NIPLI/ADATTATORI
 H ANGLE VALVE WITH NIPPLES/ADAPTERS KIT



CODICE		Ø	
7E00E3N050590A	50 mm	3/4"x3/4"	25

7E00.E3.V STRAIGHT VALVOLA H DIRITTA CON DUE GUARNIZIONI PIANE
 H STRAIGHT VALVE WITH TWO FLAT SEALS



CODICE		Ø	
7E00E3N05050VA	50 mm	3/4"x3/4"	25

7E00.E3.V
ANGLE

VALVOLA H ANGOLO CON DUE GUARNIZIONI PIANE
H ANGLE VALVE WITH TWO FLAT SEALS



CODICE	H	Ø	
7E00E3N05059VA	50 mm	3/4"x3/4"	25

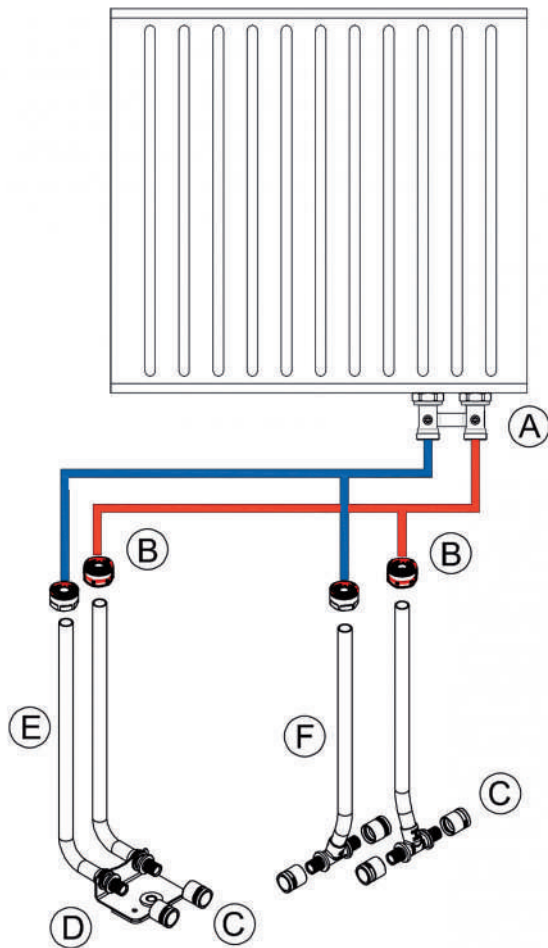

(A)	7E00E3N050500A 	
(A)	7E00E3N050590A 	
(B)	5700H4N051500A 7E00H4N051500A 	
(C)	3400.82 3400.82P 	
(D)	AC0090H3400K2H 	
(E)	3400.K2 	
(F)	3400.K8 	



**GENERAL
FITTINGS**
YOUNIQUE · ITALIAN



FEBO

VALVOLE E DETENTORI PER RADIATORE
VALVES AND LOCKSHIELDS FOR RADIATOR



HYPERION

SERIE 7500

LINE 7500

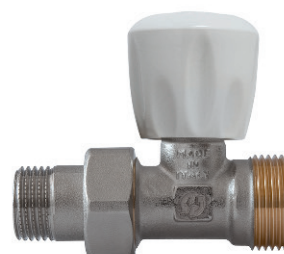

Valvole e detentori per radiatore Valves and lockshields for radiator

Le valvole sono dispositivi di intercettazione di fluidi come acqua calda e fredda negli impianti di riscaldamento e raffreddamento. Possono inoltre essere utilizzate in ogni tipo di installazione idraulica, commerciale, domestica ed industriale.

Oltre alla valvola di ingresso al corpo scaldante, è opportuno installare in uscita un detentore con funzioni di intercettazione e regolazione. I detentori General Fittings hanno l'interasse uguale alla corrispondente valvola di ingresso.

Radiator valves are devices for the interception of fluids such as hot and cold water in heating and cooling systems. In addition to the inlet valve to the heating body, a lockshield valve with interception and regulation functions should be installed at the outlet. General Fittings lockshields have the center distance equal to the corresponding inlet valve.

VANTAGGI

- Vitone con doppia tenuta [tenuta O-Ring + tenuta metallo/metallo]
- Materie prime impiegate di alta qualità [UBA LIST]

ADVANTAGES









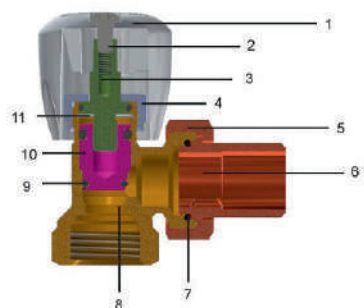

- Screw with double sealing [O-Ring or metal-to-metal tightening]
- Raw materials complying with UBA LIST

CAMPI DI APPLICAZIONI E PRESTAZIONI FIELDS OF APPLICATION

APPLICAZIONI APPLICATIONS	T. min.	T. max	Press.max Max. pressure	Press.diff. Diff. press.
 radiatori radiators	-20°C	+100°C	10 bar	1 bar
-20°C: solo con liquido antigelo, glicole, in % max del 30% -20°C: only with antifreeze liquid (glycol) in % max of 30%				

COMPONENTI E MATERIALI VALVOLA 7500.75 COMPONENTS AND MATERIALS: VALVE 7500.75



LEGENDA LEGEND	COMPONENTI COMPONENTS	MATERIALI MATERIALS
	1 Manopola Handle	ABS bianco RAL 9010 ABS white RAL 9010
	2 Vite Screw	CB4F
	3 Asta Stem	CW617N - UNI EN 12164 Brass CW617N - UNI EN 12164
	4 Tappo Cap	CW617N Brass CW617N
	5 Dado Nut	CW617N - UNI EN 12165 Brass CW617N - UNI EN 12165
	6 Codolo Pipe union	CW617N - UNI EN 12164 Brass CW617N - UNI EN 12164
	7 O-Ring codolo O-Ring pipe union	Elastomero Elastomer
	8 Corpo Body	CW617N - UNI EN 12165 Brass CW617N - UNI EN 12165
	9 O-Ring tenuta O-Ring (tighting)	Elastomero Elastomer
	10 Otturatore Cut off valve	CW617N Brass CW617N
	11 Seeger	Acciaio bonificato Hardened steel

NORMATIVE

- UN EN ISO 228-1
Filettatura di tubazioni per accoppiamento non a tenuta sul filetto

REGULATIONS

- UN EN ISO 228-1
Threads complies with UNI EN ISO 228-1:2003 law: "Piping thread for coupling not with tightness on the thread"

CERTIFICAZIONI CERTIFICATIONS

STATO COUNTRY	CERTIFICAZIONE CERTIFICATION	STATO COUNTRY	CERTIFICAZIONE CERTIFICATION	STATO COUNTRY	CERTIFICAZIONE CERTIFICATION
					
					

7500.75 VALVOLA DIRITTA CON ATTACCO PER TUBO FERRO
 STRAIGHT VALVE WITH IRON PIPE CONNECTION



CODICE	Ø	◇	☐
750075N050500A	3/4"	8	48

7500.75-90° VALVOLA A SQUADRA CON ATTACCO PER TUBO FERRO
 ANGLE VALVE WITH IRON PIPE CONNECTION



CODICE	Ø	◇	☐
750075N050590A	3/4"	8	48

7500.J9 DETENTORE DIRITTO CON ATTACCO PER TUBO FERRO
 STRAIGHT LOCKSHIELD WITH IRON PIPE CONNECTION



CODICE	Ø	◇	☐
7500J9N050500A	3/4"	8	48

7500.J9-90° DETENTORE A SQUADRA CON ATTACCO PER TUBO FERRO
 ANGLE LOCKSHIELD WITH IRON PIPE CONNECTION

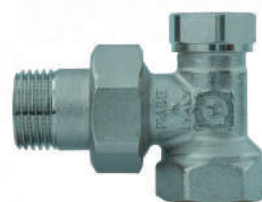

CODICE	Ø	◇	☐
7500J9N050590A	3/4"	8	48

*fino ad esaurimento scorte

* until stocks are exhausted



Comandi termostatici

Thermostatic controls



Le teste termostatiche sono dispositivi meccanici per il controllo automatico dell'afflusso di acqua al corpo scaldante, grazie a un elemento termosensibile che reagisce alle variazioni della temperatura ambiente.

La testa termostatica 7T00.89 permette di impostare la specifica temperatura di ogni stanza in maniera autonoma, così da aumentare il comfort e assicurare un risparmio energetico.

Il sensore presente all'interno della testa, infatti, consente di poter regolare la temperatura all'interno del locale, agendo in modo proporzionale sull'apertura e chiusura della valvola.

Ai fini dell'efficienza e del risparmio energetico è importante che le teste termostatiche vengano installate lontano da ostacoli [quali mensole, mobili, tendaggi ecc.] di modo che la temperatura dell'ambiente non venga falsata.

General Fittings thermostatic heads are mechanical devices for the automatic control of the flow of water to the heating body by means of a thermosensitive element that reacts to changes in the ambient temperature.

The 7T00.89 thermostatic head makes it possible to set the specific temperature of each room independently, so as to increase comfort and ensure energy savings. The sensor inside the head permits temperature calibration operating on valve opening and closure proportionally. In order to obtain efficiency and energy-saving it is important that the thermostatic head are assembled away from obstacles (such as shelf, furniture, curtains, etc.), so that room temperature cannot be falsified.

CARATTERISTICHE COSTRUTTIVE CONSTRUCTION FEATURES

CARATTERISTICHE COSTRUTTIVE CONSTRUCTION FEATURES

Intervallo di portata Temperature range	8-28°C
Intervallo di regolazione Regulation range	1-5
Protezione antigelo Freeze protection	Si YES
Regolazione 3 Setting (position 3)	20°C
Isteresi Hysteresis	0.56 K
Effetto temperatura acqua (W) Water temperature effect (W)	0.64 K
Pressione differenziale [D] Differential pressure [D]	0.30 K
Tempo di risposta(Z) Reply time (Z)	19 minuti 19 minutes
Filettatura Thread	M30x1.5

CAMPO DI REGOLAZIONE REGULATION FIELD



POSIZIONE POSITION	°C	INDICAZIONI INSTRUCTIONS
0	0°C	CHIUSO CLOSED
*	5°C	POSIZIONE ANTIGELO FREEZE PROTECTION
1	10°C	SCALE, CANTINA CELLAR, STAIRS
2	15°C	STANZE DA LETTO, STANZE PER HOBBY BEDROOMS, HOBBY AREAS
2/3	18°C	CUCINA, CORRIDOIO KITCHENS, HALLWAYS
3	20°C 20°C	ZONA LIVING, CAMERA BAMBINI LIVING ROOMS, CHILDREN'S ROOMS
3/4	24°C	BAGNO BATHROOMS

INSTALLAZIONE TESTA TERMOSTATICA OPERATING INSTRUCTIONS

Svitare la manopola di protezione montata sulla valvola.

Unscrew the safety handle mounted on the valve



Portare il selettore della testa termostatica in posizione 5.

Switch the thermostatic head to position 5.



Avvitare la testa termostatica sulla valvola e impostare il selettore sulla posizione desiderata.

Screw the thermostatic head on the valve and set the selector to the desired position.



PROCEDURA DI IMPOSTAZIONE DELLA TEMPERATURA SETTING TEMPERATURE LIMITS

La temperatura minima e massima può essere limitata utilizzando il perno di limitazione della temperatura. La fornitura standard contiene un perno che può essere utilizzato per limitare la temperatura MIN o MAX.

The minimum and maximum temperature can be set by using the temperature limitation pin. The standard unit contains a pin that can be used to limit the MIN or MAX temperature.



LIMITAZIONE DELLA TEMPERATURA MINIMA LIMITING THE MINIMUM TEMPERATURE

Rimuovere il perno dalla posizione MAX

Remove the pin from its MAX position

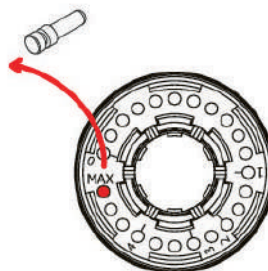

Ruotare la testina nella posizione della temperatura minima desiderata

Rotate the head to the desired minimum temperature setting

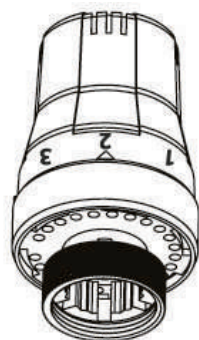

Inserire il perno nella parte posteriore della gradazione 0

Insert the pin in the back part of the 0 degree setting

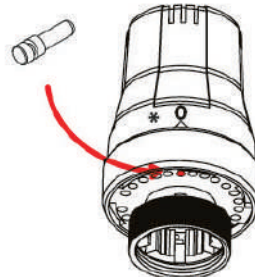

LIMITAZIONE DELLA TEMPERATURA MASSIMA SETTING THE MAXIMUM TEMPERATURE

Rimuovere il perno dalla posizione MAX

Remove the pin from its MAX position

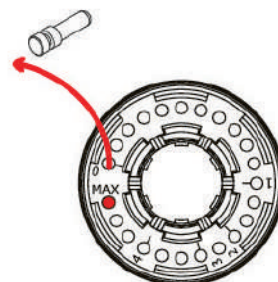

Girare la testa nella posizione antigelo

Rotate the head to the freeze protection setting

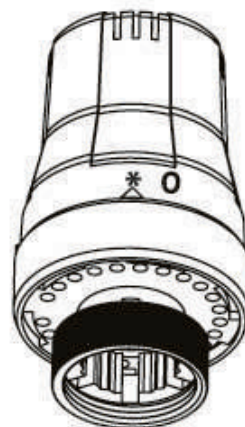

Inserire il perno nella parte posteriore contrassegnata con il numero appropriato di limitazione della temperatura (0- 4), ad esempio nella posizione 4.

Insert the pin in the back part marked with the applicable temperature limitation number (0-4), for example, in position 4.

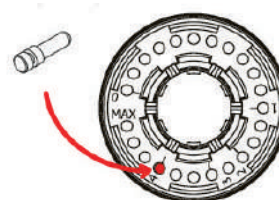

LIMITAZIONE DELLA TEMPERATURA MINIMA E MASSIMA SETTING THE MINIMUM AND MAXIMUM TEMPERATURE

Rimuovere i perni dalle posizioni MAX e 0

Remove the pins from the MAX and 0 positions

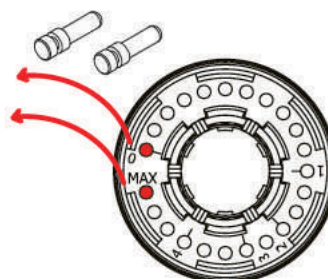

Ruotare la testa nella posizione della temperatura minima desiderata

Rotate the head to the desired minimum temperature



Inserire un perno nella parte posteriore della gradazione 0

Insert one pin in the back part of the 0 degree setting

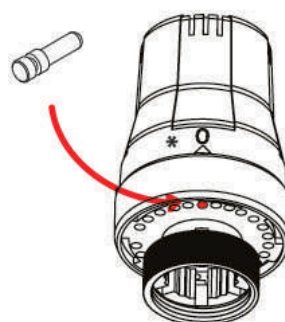

Inserire l'altro perno nella parte posteriore contrassegnata con il numero appropriato di limitazione della temperatura (0-4).

Insert the other pin in the back part marked with the applicable temperature limitation number (0-4).

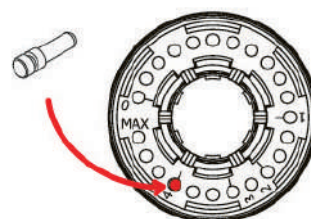

AVVERTENZE CORRETTO FUNZIONAMENTO OPERATING WARNINGS

Installazione corretta

Correct installation



NON devono essere colpite dai raggi solari

They should not be affected by sunlight



NON INSTALLARE sotto ripiani o mensole.

Do not install under the shelves



NON INSTALLARE all'interno di nicchie.

Do not install inside niches



NON INSTALLARE dietro le tende.

Do not install behind the curtains



NON INSTALLARE all'interno del flusso d'aria.

Do not install inside the airflow



7T00.89

TESTINA TERMOSTATICA
THERMOSTATIC HEAD



CODICE

Ø

7T0089H301500A

m30x1.5



ADATTATORI ED INSERTI PER VALVOLE RADIATORE

ADAPTERS AND INSERTS FOR RADIATOR VALVES

Gli adattatori consentono una facile connessione alle varie tipologie di tubazioni.

The adapters allow easy connection to the various types of pipes.

3300.80 DADO NICHELATO, OGIVA E INSERTO EUROCONO PER TUBO PE-X
 NICKEL-PLATED NUT, OLIVE AND INSERT EUROCONE FOR PE-X PIPE



CODICE	+	Ø	◇	☐
330080N051013A	1.3	3/4"EKx10	10	150
330080N051420A	2.0	3/4"EKx14	10	100
330080N051615A	1.5	3/4" EKx16	10	100
330080N051620A	2.0	3/4"EKx16	10	100
330080N051622A	2.2	3/4"EKx16	10	100
330080N051720A	2.0	3/4"EKx17	10	100
330080N051618A	1.8	3/4" EKx16	10	100
330080N051820A	2.0	3/4"EKx18	10	100
330080N051825A	2.5	3/4"EKx18	10	100
330080N052020A	1.9-2.0	3/4"EKx20	10	100
330080N052028A	2.8	3/4"EKx20	10	100

2700.H4 DADO NICHELATO CON OGIVA E GUARNIZIONE PER TUBO RAME
 NICKEL-PLATED NUT WITH ASSEMBLED RING AND GASKET FOR COPPER PIPE



CODICE	Ø	◇	☐
2700H4N051000H	3/4"EKx10	10	200
2700H4N051200H	3/4"EKx12	10	200
2700H4N051400H	3/4"EKx14	10	200
2700H4N051500H	3/4"EKx15	10	200
2700H4N051600H	3/4"EKx16	10	200
2700H4N051800H	3/4"EKx18	10	200

5700.H4 DADO NICHELATO CON OGIVA E GUARNIZIONE PER TUBO RAME
 NICKEL-PLATED NUT WITH ASSEMBLED RING AND GASKET FOR COPPER PIPE



CODICE	Ø	◇	☐
5700H4N051500A	3/4"EKx15	10	100

5700.80 DADO NICHELATO, OGIVA E INSERTO EUROCONO PER TUBO MULTISTRATO
 NICKEL-PLATED NUT, OLIVE AND INSERT EUROCONE FOR MULTILAYER PIPE



CODICE	+	Ø	◇	☐
570080N051216A	1.6	3/4" EKx12	10	100
570080N051620A	2.0	3/4"EKx16	10	100
570080N051720A	2.0	3/4"EKx17	10	100
570080N051620A	2.0	3/4"EKx16	10	100
570080N051820A	2.0	3/4"EKx18	10	100
570080N052020A	2.0	3/4"EKx20	10	100
570080N052022A	2.25	3/4"EKx20	10	100
570080N052025A	2.5	3/4"EKx20	10	100

6300.85 ADATTATORE SEDE PIANA EUROKONO
EUROCONE FLAT SEAL ADAPTER



CODICE			
630085H050000H	3/4"	10	500

6300.80 DADO NICHELATO, OGIVA E INSERTO EUROCONO
NICKEL-PLATED NUT, OLIVE AND INSERT
EUROCONE



CODICE		i	ϕ		
630080N051618A	1.8	per tubo multistrato	3/4" EKx16	10	100
630080N051620A	2.0	per tubo multistrato	3/4" EKx16	10	100
630080N051720A	2.0	per tubo Pe-x	3/4" EKx17	10	100
630080N051820A	2.0	per tubo multistrato	3/4" EKx18	10	100
630080N052020A	2.0	per tubo multistrato	3/4" EKx20	10	100

7E00.H4 KIT EUROKONO RAME/ACCIAIO NICHELATO
NICKEL-PLATED EUROCONE ADAPTER FOR
COPPER/STEEL PIPE



CODICE	ϕ		
7E00H4N051500A	3/4" EKx15	10	120

6300.80NX DADO NICHELATO, OGIVA E INSERTO EUROCONO
NICKEL-PLATED NUT, OLIVE AND INSERT EUROCONE



CODICE		i	ϕ		
630080NX51626A	2.6	Pe-x Al Pe-x 16x2.6	3/4" EKx16	10	100
630080NX52029A	2.9	Pe-x Al Pe-x 20x2.9 / Pex 20x2.8	3/4" EKx20	10	100

CONDIZIONI GENERALI DI VENDITA
DI GENERAL FITTINGS S.p.A.
Rel. 04/2021

1. DEFINIZIONI

Con "Venditrice" si intende General Fittings S.p.A., c.f. 01613110178, p.i. 03448140172, con sede in Gussago (BS), 25064, via Golgi n. 73/75; con "Acquirente" si intende la persona, azienda o società a cui l'Offerta della Venditrice, la Conferma d'Ordine e la fattura sono rivolte.

2. AMBITO DI APPLICAZIONE E CLAUSOLE AGGIUNTIVE

Le presenti condizioni generali si applicano ad ogni singolo Ordine o Contratto per la fornitura di beni e servizi resi dalla Venditrice e prevalgono su eventuali condizioni generali dell'Acquirente.

Eventuali clausole contrattuali ulteriori o difformi rispetto a quanto previsto alle presenti condizioni generali sono valide esclusivamente se risultanti da accordo scritto.

3. CATALOGHI E LISTINI

Gli articoli, le misure, le caratteristiche ed i prezzi dei prodotti indicati nei cataloghi e nei listini della Venditrice sono puramente indicativi. Essi possono essere variati senza preavviso. Essi hanno valore vincolante esclusivamente dopo la conclusione del Contratto quando siano riportati nella Conferma d'Ordine.

4. OFFERTE E CONCLUSIONE DEL CONTRATTO

Le Offerte e le Proposte della Venditrice non sono vincolanti; esse scadono dopo 30 giorni dalla data di emissione.

A seguito dell'Ordine dell'Acquirente la Venditrice invierà all'Acquirente una Conferma d'Ordine indicante i prezzi e i dati della fornitura.

Il Contratto si concluderà con la ricezione da parte della Venditrice della accettazione della Conferma d'Ordine sottoscritta dall'Acquirente oppure con il decorso di due giorni dall'invio della Conferma d'Ordine senza che l'Acquirente abbia fatto pervenire alcuna comunicazione alla Venditrice. In tale ultimo caso il comportamento dell'Acquirente equivale ad accettazione della proposta contrattuale contenuta nella Conferma d'Ordine

5. CERTIFICAZIONI

Eventuali certificazioni di prodotto e/o dichiarazioni di conformità devono essere richieste dall'Acquirente nella domanda di Preventivo e, in ogni caso, prima della conclusione del Contratto.

6. TERMINI DI CONSEGNA

I termini di consegna previsti o concordati sono puramente indicativi e sono suscettibili di cambiamento durante le fasi di preparazione dei prodotti.

La Venditrice non risponde per danni causati da ritardi nella consegna. Il mero ritardo nella consegna non può costituire causa di risoluzione del contratto.

7. CONSEGNA

Il luogo di consegna convenuto è presso l'unità di produzione indicata nell'offerta e dove non specificato è Franco Fabbrica (Incoterms 2010).

La consegna avviene con l'affidamento della merce a vettore o spedizioniere. Trasporto, assicurazione e altri costi connessi alla spedizione sono a carico dell'Acquirente. Nessuna responsabilità è attribuibile alla Venditrice, né per perdite o danni di qualsiasi natura causati da stivaggio, carico e/o trasporto.

Nessuna responsabilità è attribuibile alla Venditrice anche quando l'Acquirente prevede trasporto delle merci con il proprio veicolo o con vettori da lui scelti. L'Acquirente ha la responsabilità di ispezionare la merce in entrata.

L'imballaggio non è incluso nel prezzo ed è a carico dell'Acquirente. La restituzione di prodotti è possibile esclusivamente previa autorizzazione scritta.

8. MANCANZA DI DATI PER LA SPEDIZIONE

L'Acquirente che non abbia fornito riferimenti precisi per la spedizione deve ritirare la merce entro e non oltre una settimana dalla notifica di merce pronta. In caso contrario la Venditrice avrà il diritto di fatturare la merce, provvedere all'immagazzinamento del materiale e addebitare all'Acquirente i relativi costi.

9. RECESSO

La Venditrice ha facoltà di recedere dal Contratto qualora intervengano fatti (quali a mero titolo esemplificativo: difficoltà nell'accesso ai fattori produttivi, aumento del prezzo delle materie prime, problematiche organizzative, ecc.) che, a

giudizio insindacabile della Venditrice, siano tali da non consentire l'utile prosecuzione del rapporto contrattuale. In tal caso, all'Acquirente non spetta alcun risarcimento od indennizzo.

10. RECLAMI

I reclami e qualsiasi contestazione devono essere fatti per iscritto entro e non oltre 8 giorni dal ricevimento della merce ed indirizzati alla sede della Venditrice utilizzando l'apposito modulo da richiedere all'indirizzo mail service@generalfittings.it.

In mancanza, i prodotti si riterranno conformi al Contratto concluso e la Venditrice non risponderà per errori, vizi, mancanza di qualità.

La presentazione di un reclamo non consente all'Acquirente di omettere o ritardare il pagamento del prezzo.

11. GARANZIE ED ESTENSIONE DI GARANZIA DECENNALE

La garanzia è fornita a termini di legge (1490 c.c. e seguenti), purché il prodotto venga installato a regola d'arte, secondo le modalità/istruzioni di montaggio e collaudo previste dalla legge e/o dal Venditore.

Per l'estensione della garanzia vedi pagine seguenti.

12. RESPONSABILITÀ CIVILE DI PRODOTTO

La Venditrice per poter aprire il reclamo RC di prodotto deve ricevere tutte le informazioni, comprese le immagini dei prodotti difettosi nella zona in cui sono stati installati ed uno o più campioni di prodotto.

Il reclamo deve avvenire utilizzando l'apposito modulo da richiedere all'indirizzo mail service@generalfittings.it.

Alla Venditrice deve essere data l'occasione, entro 8 giorni dalla data del supposto danno e comunque prima di qualsiasi intervento atto a rimediare, di ispezionare lo stato dei luoghi.

In relazione ai tempi di prescrizione per la responsabilità civile di prodotto la Venditrice si attiene alle normative di legge nazionali e comunitarie.

13. LIMITAZIONI DI RESPONSABILITÀ

L'Acquirente, tramite l'Ordine, è responsabile del rispetto di tutti i requisiti di sicurezza e di legge connessi al prodotto acquistato.

La Venditrice non è responsabile per qualsiasi danno diretto o indiretto a persone o cose causato da un uso

improprio del prodotto fornito.

In ogni caso, la Venditrice non è responsabile per qualsiasi danno diretto o indiretto a persone o cose qualora non siano rispettate le ipotesi previste all'art. 11 delle presenti condizioni generali, punto 2. Condizioni) o qualora sussista una delle ipotesi previste all'art. 11 delle presenti condizioni generali, punto 3. Decadenze).

14. CONTESTAZIONE DELLE FATTURE

Le fatture della Venditrice possono essere contestate esclusivamente in forma scritta entro e non oltre 30 giorni dal ricevimento delle stesse. In mancanza, le stesse si ritengono integralmente accettate

15. PAGAMENTI, FACOLTÀ DI SOSPENSIONE DELLE FORNITURE, DECADENZA DAL BENEFICIO DEL TERMINE, GARANZIE DI PAGAMENTO

I pagamenti devono essere effettuati presso la sede della Venditrice secondo le modalità e i termini indicati nella Conferma d'Ordine.

Le modalità di pagamento concordate non importano alcuna modifica al luogo previsto per il pagamento.

Qualora l'Acquirente non effettuasse i pagamenti entro i termini concordati la Venditrice avrà il diritto di addebitare gli interessi commerciali di mora (Decreto legislativo n. 231/2002) e di ottenere il rimborso delle spese sostenute per gli effetti e le rimesse insolute nonché le spese di recupero legale, senza la necessità di messa in mora di inadempienza.

Ogni ritardo o irregolarità nei pagamenti darà alla Venditrice la facoltà di interrompere le forniture, anche se non direttamente connesse con i pagamenti interessati da ritardo.

Qualora sia previsto un pagamento dilazionato, ogni ritardo o irregolarità nei pagamenti comporterà l'automatica decadenza dell'Acquirente dal beneficio del termine, con immediata esigibilità dell'intero ammontare dovuto dall'Acquirente anche in relazione a forniture non direttamente connesse con i pagamenti interessati da ritardo o irregolarità.

La Venditrice ha il diritto di modificare i termini di pagamento per future forniture e richiedere anticipi di pagamento.

La Venditrice, anche nel corso dell'esecuzione del Contratto, potrà richiedere idonee garanzie di pagamento. Nel caso in cui le garanzie richieste non vengano concesse la Venditrice potrà sospendere l'esecuzione del contratto.

16. LEGGE APPLICABILE, GIURISDIZIONE E FORO COMPETENTE

Al rapporto tra Venditrice ed Acquirente si applica la legge e la giurisdizione italiana; per qualsiasi controversia è competente in via esclusiva il Giudice del Foro di Brescia.

ESTENSIONE DI GARANZIA CONVENZIONALE DECENNALE

11.1. Oggetto

Tutti i prodotti della Venditrice sono garantiti per 10 (dieci) anni dalla data di emissione della fattura con cui gli stessi prodotti vengono forniti.

La garanzia fornita riguarda esclusivamente la sostituzione pura e semplice di prodotti o di componenti degli stessi che risultino difettosi a causa di un difetto di fabbricazione tale per cui i prodotti non siano utilizzabili per l'uso ordinario cui gli stessi possono essere destinati.

È escluso dalla garanzia qui fornita ogni risarcimento per spese e/o danni causati dal prodotto difettoso a cose e/o persone.

È esclusa dalla garanzia qui fornita la normale obsolescenza dei prodotti o di particolari elementi degli stessi.

Sono esclusi dalla garanzia qui fornita i seguenti prodotti: motori, tubi, guarnizioni, ...

Sono esclusi dalla garanzia qui fornita prodotti e componenti degli stessi venduti dalla Venditrice ma non prodotti dalla stessa.

La garanzia qui fornita è operativa su tutto il territorio nazionale italiano ed europeo.

La garanzia qui fornita è valida esclusivamente se l'Acquirente ha fatto pervenire alla Venditrice l'accettazione espressa delle presenti condizioni generali tramite sottoscrizione in calce delle stesse. In mancanza, la Venditrice sarà tenuta a prestare esclusivamente la garanzia secondo le vigenti norme di legge.

È onere di chi intende attivare la garanzia provare il difetto di fabbricazione del prodotto, il fatto che esso non fosse riconoscibile al ricevimento del prodotto stesso (vedi articolo 10 delle presenti condizioni generali), e l'avvenuta sottoscrizione delle presenti condizioni generali da parte dell'Acquirente.

In mancanza anche di uno solo di questi elementi, la Venditrice non sarà tenuta a prestare la garanzia convenzionale qui fornita.

Per poter essere sostituiti, i prodotti difettosi devono

essere anticipatamente restituiti alla Venditrice. La restituzione dei prodotti difettosi, in ogni caso, deve essere sempre concordata anticipatamente con la Venditrice.

La garanzia è da ritenersi valida esclusivamente nel rispetto delle condizioni indicate al seguente punto 11.2.

La garanzia decade nei casi indicati al seguente punto 11.3.

Dovranno sempre essere rispettate le Indicazioni di posa e protezione contro la corrosione esterna indicate al seguente punto 11.4.

11.2. Condizioni

- I tubi ed i raccordi devono essere installati secondo le indicazioni contenute nel manuale d'installazione, definito nel catalogo generale della Venditrice.
- Nessuna manomissione o alterazione dei prodotti deve essere intervenuta successivamente al periodo di produzione, anche solamente per cause accidentali.
- Le condizioni di esercizio (temperature, pressioni, natura dei liquidi, tensionamenti) debbono rientrare nei parametri indicati nel manuale d'installazione, definito nel catalogo generale della Venditrice.
- I manufatti oggetto di richiesta devono espressamente riportare i marchi di fabbrica.

11.3. Decadenza

- Mancata o errata osservanza, anche parziale, delle istruzioni di installazione fornite dal produttore.
- Mancata o errata osservanza delle regole dell'arte o delle regole specifiche della buona tecnica.
- Utilizzo di materiale deteriorato e quindi non idoneo: tubo e raccordi invecchiati o scalfiti, schiacciati ecc.
- Impiego di materiali non forniti dalla Venditrice (tubi e raccordi).
- Impianto realizzato e messo a punto da un installatore termosantario non specializzato o non patentato.
- Mancato rispetto delle indicazioni di posa e protezione contro la corrosione esterna di cui al seguente punto

11.4.

- Mancanza della prova di impianto e della relativa documentazione.

11.4. Indicazioni di posa e protezione contro la corrosione esterna

Al fine di evitare malfunzionamenti dei prodotti in ottone si consiglia di installarli e isolarli in una cassetta ispezionabile o comunque di proteggerli con materiali idonei.

Per la loro protezione si devono utilizzare materiali anti-corrosione ed impermeabili, che inibiscono la corrosione da possibili agenti chimici, e materiali resistenti al calore e all'invecchiamento.

Le presenti indicazioni di posa sono da applicare congiuntamente alle istruzioni di montaggio definite per ogni singola gamma di prodotto e debitamente riportate nel catalogo della Venditrice

11.5. Diritti del consumatore

Si specifica che il Consumatore è titolare dei diritti previsti dal Codice del Consumo (Decreto legislativo n. 206/2005) agli articoli 128 e seguenti e che la presente garanzia convenzionale lascia impregiudicati tali diritti.

*L'Acquirente
(timbro e firma)*

Ai sensi e per gli effetti dell'art. 1341 e 1342 del Codice Civile, in quanto applicabili, l'Acquirente dichiara di approvarne specificatamente i seguenti articoli delle condizioni generali di vendita applicate da General Fittings S.p.A.:

- 2. Ambito di applicazione e clausole aggiuntive;*
- 6. Termini di consegna;*
- 9. Recesso;*
- 10. Reclami;*
- 11. Garanzia ed estensione di garanzia decennale;*
- 13 Limitazioni di responsabilità;*
- 14. Contestazione delle fatture;*
- 15. Pagamenti, facoltà di sospensione delle forniture, decadenza dal beneficio del termine, garanzie di pagamento;*
- 16. Legge applicabile, giurisdizione e Foro competente.*

In data

*L'Acquirente
(timbro e firma)*

GENERAL SALE CONDITIONS
APPLIED BY
GENERAL FITTINGS S.p.A.
Rel. 04/2021

1. DEFINITIONS

"Vendor" means General Fittings S.p.A., Tax Code. 01613110178, Vat Cod., 03448140172, based in Gussago (BS), 25064, via Golgi n. 73/75; "Buyer" means the person, company or company to whom the Seller's Offer, Order Confirmation and invoice are addressed.

2. SCOPE OF APPLICATION AND ADDITIONAL CLAUSES

These general conditions apply to every single Order or Contract for the supply of goods and services rendered by the Seller and prevail over any general conditions of the Purchaser.

Any additional or different contractual clauses with respect to the provisions of these general conditions are valid only if they result from a written agreement.

3. CATALOGS AND PRICE LISTS

The articles, measures, characteristics and prices of the products indicated in the catalogs and the price lists of the Seller are purely indicative. They can be changed without notice. They are binding only after the conclusion of the Contract when they are indicated in the Order Confirmation.

4. OFFERS AND CONCLUSION OF THE CONTRACT

The Offers and Proposals of the Seller are not binding; they expire after 30 days from the date of issue.

Following the Order of the Purchaser, the Seller will send the Purchaser an Order Confirmation indicating the prices and details of the supply.

The Contract will end with the receipt by the Seller of the acceptance of the Order Confirmation signed by the Purchaser.

5. CERTIFICATIONS

Any product certifications and / or declarations of conformity must be requested by the Purchaser in the Request for Quotation and, in any case, before the conclusion of the Contract.

6. TERMS OF DELIVERY

The expected or agreed delivery terms are purely indicative and they are likely to change during the preparation stages of the products.

The Seller is not liable for damages caused by delays in delivery. The mere delay in delivery cannot constitute grounds for termination of the contract.

7. DELIVERY

The agreed place of delivery is at the production unit indicated in the offer and where not specified is Ex Works (Incoterms 2010).

Delivery takes place with the assignment of the goods to the carrier or forwarder. Transport, insurance and other costs associated with shipping are to be paid by the Purchaser.

No responsibility is attributable to the Seller, nor for losses or damages of any kind caused by stowage, loading and / or transport.

No responsibility is attributable to the Seller even when the Purchaser provides for transportation of the goods with his own vehicle or with carriers chosen by him.

The Purchaser is responsible for inspecting the incoming goods.

The packaging is not included in the price and it is in charge of the Purchaser.

The return of products is possible after written authorization only.

8. LACK OF DATA FOR SHIPMENT

The Purchaser who has not provided detailed references for shipping must collect the goods no later than one week from the notification of goods ready. Otherwise the Seller will have the right to invoice the goods, to stock the material and to charge the Buyer for the related costs.

9. WITHDRAWAL

The Seller has the right to withdraw from the Contract if there are any facts (such as merely an example: difficulty in accessing the inputs, increase in the price of raw materials, organizational problems, etc.) which, at the unquestionable judgment of the Seller, are such do not allow the useful continuation of the contractual relationship. In this case, the Buyer is not entitled to any compensation or indemnity.

10. COMPLAINTS

Complaints and any claims must be made in writing no later than 8 (eight) days of receipt of goods and addressed to the headquarters of the Seller using templates to be asked to service@generalfittings.it mail. Failing this, the products will be deemed compliant with the concluded Contract and the Seller will not be liable for errors, faults or lack of quality. The filing of a claim does not allow the Purchaser to omit or delay payment of the price.

11. WARRANTIES AND 10-YEAR WARRANTY EXTENSION

The warranty is provided in accordance with the law (1490 of the Italian Civil Code and following), provided that the product is installed in a workmanlike manner, according to the assembly and testing methods / instructions provided for by law and / or by the Seller. For extended warranty see following pages.

12. PRODUCT CIVIL LIABILITY

To open the product liability claim, the Seller must receive all information, including images of defective products in the area in which they were installed and one or more defective samples in support. The complaint must be made using the templates to be asked to service@generalfittings.it mail. The Seller must be given the opportunity, within 8 days from the date of the alleged damage and in any case before any intervention to remedy the situation, to inspect the condition of the places. The prescription times for the product liability, the seller complies with the national and EU laws.

13. LIABILITY LIMITATIONS

The Purchaser, through the Order, is responsible for compliance with all the safety and legal requirements related to the product purchased. The Seller is not responsible for any direct or indirect damage to persons or property caused by improper use of the supplied product. In any case, the Seller is not responsible for any direct or indirect damage to persons or property if the assumptions provided for in art. 11 of the present general conditions, point 2. Conditions) or if one of the hypotheses provided for by art. 11 of the present general conditions, point 3. Decadences).

14. CLAIM OF INVOICES

The Seller's invoices may be contested only in writing within and no later than 30 days from receipt of the same. Failing this, they are considered fully accepted.

15. PAYMENTS, FACULTY OF SUSPENSION OF SUPPLIES, DEADLINE FROM THE BENEFIT OF THE TERM, PAYMENT GUARANTEES

Payments must be made at the Seller's premises according to the terms and conditions indicated in the Order Confirmation. The agreed payment methods do not change any changes to the place for payment. If the Purchaser does not make the payments within the agreed terms, the Seller will have the right to charge the commercial interest for late payment (Legislative Decree No. 231/2002) and to obtain reimbursement of expenses incurred for the effects and remittances outstanding as well as the legal recovery costs, without the need for a default notice.

Any delay or irregularity in payments will give the Seller the right to discontinue supplies, even if not directly connected to the payments affected by delay. If a deferred payment is envisaged, any delay or irregularity in payments will result in the automatic forfeiture of the Buyer from the benefit of the term, with immediate payment of the entire amount due by the Purchaser also in relation to supplies not directly connected to the payments affected by delay or irregularity.

The Seller has the right to change the payment terms for future supplies and request payment advances. The Seller, even during the execution of the Contract, can request suitable payment guarantees. In the event that the required guarantees are not granted, the Seller may suspend the execution of the contract.

16. APPLICABLE LAW, JURISDICTION, COMPETENT COURT

The law and the Italian jurisdiction apply to the relationship between Seller and Purchaser; for any disputes exclusive jurisdiction is the Court of Brescia (Italy).

EXTENSION OF DECANTAL CONVENTIONAL WARRANTY

11.1. Subject

All products of the Seller are guaranteed for 10 (ten) years from the date of issue of the invoice with which the same products are supplied.

The guarantee provided only concerns the pure and simple replacement of products or of particular components of the same which are defective due to a manufacturing defect such that the products cannot be used for ordinary use to which they may be destined. Any guarantee for expenses and / or damages caused by the defective product to things and / or people is excluded from the guarantee given here.

The normal obsolescence of the products or of particular elements of the same is excluded from the guarantee given here.

The following products are excluded from the guarantee given here: engines, pipes, gaskets, ...

Products and particular components of the same ones sold by the Seller but not produced by the same are excluded from the warranty provided here.

The guarantee provided here is operative throughout the Italian and European national territory.

The guarantee given here is valid only if the Purchaser has sent the Seller express acceptance of these general conditions by signing them at the bottom.

Failing this, the Seller will be required to provide exclusively the guarantee according to the current laws.

It is the responsibility of those who intend to activate the warranty to prove the defect of the manufacture of the product, the fact that it was not recognizable upon receipt of the product (see article 10 of these general conditions), the invoice of the Seller with which the product was supplied and the signing of the present general conditions by the Purchaser.

In the absence of even one of these elements, the Seller will not be required to provide the conventional guarantee.

In order to be replaced, defective products must be returned to the Seller in advance.

The return of defective products, in any case, must always be agreed in advance with the Seller.

The warranty is to be considered valid only in compliance with the conditions indicated in the following point 11.2.

The guarantee lapses in the cases indicated in the

following point 11.3.

The external Laying and Protection Indications indicated in the following point 11.4 must always be observed.

11.2. Conditions

- Pipes and fittings must be installed according to the instructions contained in the installation manual, defined in the general catalog of the Seller.
- No tampering or alteration of the products must have occurred after the production period, even only due to accidental causes.
- The operating conditions (temperatures, pressures, nature of liquids, tensioning) must fall within the parameters indicated in the installation manual, defined in the general catalog of the Seller.
- The items object of request must expressly bring the trademarks.

11.3. Decadency

- Failure or incorrect observance, even partial, of the installation instructions provided by the manufacturer.
- Missed or incorrect observance of the rules of art or of the specific rules of good technique.
- Use of deteriorated and therefore unsuitable materials: pipes and fittings that have been aged or scratched, crushed, etc..
- Use of materials not supplied by the Seller (pipes and fittings).
- Plant built and developed by a non-specialized or unlicensed thermosanitary installer.
- Failure to comply with the instructions for Laying and Protection against external corrosion referred to in point 11.4 below.
- Lack of plant test and related documentation.

11.4. Laying and protection against external corrosion

In order to avoid failure of the brass products, it is advisable to isolate the fittings in an inspectable box or in any case protect them with appropriate materials. For their protection, anti-corrosion and waterproof materials must be used, that inhibit corrosion from possible chemical agents, and materials resistant to heat and aging.

These installation instructions must be applied in conjunction with the assembly instructions defined for each individual product range and duly shown in the Seller's catalog.

11.5. Consumer rights

It is specified that the Consumer is the owner of the rights established by the Consumer Code (Legislative Decree No. 206/2005) in Articles 128 et seq. And that this Conventional Warranty is without prejudice to such rights.

Date ...

The Purchaser
(Stamp and Signature)

Pursuant to and for the effects of art. 1341 and 1342 of the Civil Code, as applicable, the Purchaser declares to approve specifically the following articles of the general conditions of sale applied by General Fittings S.p.A.

2. Scope of application and additional clauses;
6. Terms of delivery;
9. Withdrawal;
10. Complaints;
11. Warranty and 10-year warranty extension;
- 13 Limitations of liability;
14. Dispute of invoices;
15. Payments, right to suspend deliveries, forfeiture of the term benefit, payment guarantees;
16. Applicable law, jurisdiction and competent court.

Date

The Purchaser
(Stamp and Signature)

General Fittings Spa non si assume alcuna responsabilità per eventuali inesattezze dovute a errori di stampa. General Fittings Spa si riserva il diritto di modificare in qualsiasi momento e senza preavviso le confezioni e le specifiche dei prodotti al fine di migliorarne l'utilizzo. Gli accordi commerciali tra gli acquirenti e General Fittings Spa sono regolati dalle Condizioni Generali di Vendita riportate sul sito ufficiale: www.generalfittings.it.

General Fittings Spa accepts no responsibility for any inaccuracies due to printing errors. General Fittings Spa reserves the right to change packaging and product specifications at any time and without notice in order to improve their use. Commercial transactions between buyers and General Fittings Spa are governed by the General Sales Conditions shown on the official website: www.generalfittings.it



www.generalfittings.it

MKCAT2024ITAEN



General Fittings Spa
Via Golgi, 73/75
25064 Gussago (BS) ITALY
T +39 030 3739017 - F +39 030 3739021
info@generalfittings.it
www.generalfittings.it

